



**OWNER'S MANUAL  
USO E MANUTENZIONE  
MANUAL DEL PROPIETARIO**



**CB1300/S/A/SA**



**Honda CB1300/S/A/SA**

**OWNER'S MANUAL**

**USO E MANUTENZIONE**

**MANUAL DEL PROPRIETARIO**

## **IMPORTANT INFORMATION**

- **OPERATOR AND PASSENGER**

This motorcycle is designed to carry the operator and one passenger. Never exceed the maximum weight capacity as shown on the accessories and loading label.

- **ON-ROAD USE**

This motorcycle is designed to be used only on the road.

- **READ THIS OWNER'S MANUAL CAREFULLY**

Pay special attention to the safety messages that appear throughout the manual. These messages are fully explained in the "A Few Words About Safety" section which appears before the Contents page.

This manual should be considered a permanent part of the motorcycle and should remain with the motorcycle when resold.

# **Honda CB1300/S/A/SA OWNER'S MANUAL**

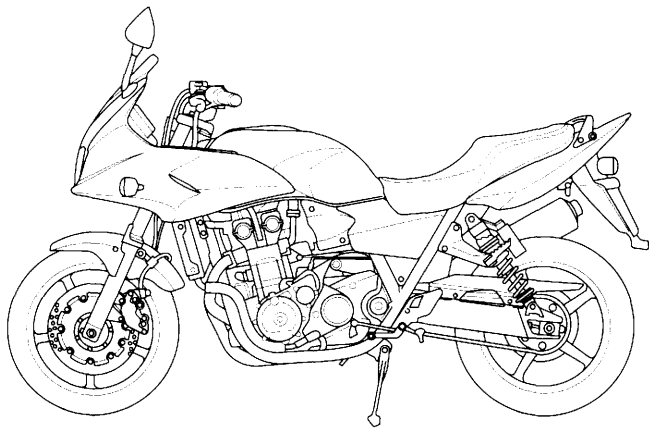

**All information in this publication is based on the latest production information available at the time of approval for printing. Honda Motor Co.,Ltd. reserves the right to make changes at any time without notice and without incurring any obligation.**

**No part of this publication may be reproduced without written permission.**

## WELCOME

The motorcycle presents you a challenge to master the machine, a challenge to adventure. You ride through the wind, linked to the road by a vehicle that responds to your commands as no other does. Unlike an automobile, there is no metal cage around you. Like an airplane, a pre-ride inspection and regular maintenance are essential to your safety. Your reward is freedom.

To meet the challenges safely, and to enjoy the adventure fully, you should become thoroughly familiar with this owner's manual **BEFORE YOU RIDE THE MOTORCYCLE**.

As you read this manual, you will find information that is preceded by a **NOTICE** symbol. This information is intended to help you avoid damage to your motorcycle, other property, or the environment.

When service is required, remember that your Honda dealer knows your motorcycle best. If you have the required mechanical "know-how" and tools, your dealer can supply you with an official Honda Service Manual to help you perform many maintenance and repair tasks.

Pleasant riding, and thank you for choosing a Honda !

- The following codes in this manual indicate each country.
- The illustrations herein are based on the CB1300SA type.

### CB1300/A/SA

E	UK	EK	Ireland
F	France		
ED	European direct sales		
	Austria	Hungary	Romania
	Belgium	Iceland	Russia
	Bulgaria	Israel	Slovakia
	Croatia	Italy	Slovenia
	Czech	Latvia	Spain
	Denmark	Luxembourg	Sweden
	Finland	Macedonia	Switzerland
	Germany	Norway	Ukraine
	Greece	Poland	
	Holland	Portugal	

### CB1300/S

U	Australia New Zealand
---	--------------------------

- The specifications may vary with each locale.

## A FEW WORDS ABOUT SAFETY

Your safety, and the safety of others, is very important. And operating this motorcycle safely is an important responsibility.

To help you make informed decisions about safety, we have provided operating procedures and other information on labels and in this manual. This information alerts you to potential hazards that could hurt you or others.

Of course, it is not practical or possible to warn you about all hazards associated with operating or maintaining a motorcycle. You must use your own good judgment.

You will find important safety information in a variety of forms, including:

- **Safety Labels** — on the motorcycle.
- **Safety Messages** — preceded by a safety alert symbol  and one of three signal words: **DANGER, WARNING, or CAUTION.**

These signal words mean:



**▲ DANGER**

You **WILL** be **KILLED** or **SERIOUSLY HURT** if you don't follow instructions.

**▲ WARNING**

You **CAN** be **KILLED** or **SERIOUSLY HURT** if you don't follow instructions.

**▲ CAUTION**

You **CAN** be **HURT** if you don't follow instructions.

- **Safety Headings** — such as Important Safety Reminders or Important Safety Precautions.
- **Safety Section** — such as Motorcycle Safety.
- **Instructions** — how to use this motorcycle correctly and safely.

This entire manual is filled with important safety information — please read it carefully.

# OPERATION

page

<b>1</b>	<b>MOTORCYCLE SAFETY</b>
1	IMPORTANT SAFETY INFORMATION
2	PROTECTIVE APPAREL
4	LOAD LIMITS AND GUIDELINES
<b>8</b>	<b>PARTS LOCATION</b>
11	INSTRUMENTS AND INDICATORS
<b>47</b>	<b>MAJOR COMPONENTS</b> (Information you need to operate this motorcycle)
47	SUSPENSION
51	HANDLEBAR POSITION
52	BRAKES
55	CLUTCH
57	COOLANT
59	FUEL
62	ENGINE OIL
63	TUBELESS TYRES

page

<b>69</b>	<b>ESSENTIAL INDIVIDUAL COMPONENTS</b>
69	IGNITION SWITCH
70	KEYS
72	IMMOBILIZER SYSTEM (HISS)
75	RIGHT HANDLEBAR CONTROLS
77	LEFT HANDLEBAR CONTROLS

page

## **78 FEATURES**

**(Not required for operation)**

- 78 STEERING LOCK
- 79 SEAT
- 80 HELMET HOLDER
- 81 DOCUMENT BAG
- 82 CENTER COMPARTMENT
- 83 STORAGE COMPARTMENT FOR  
U-SHAPED ANTI-THEFT LOCK
- 84 RIGHT POCKET
- 85 LEFT POCKET
- 86 SIDE COVER
- 87 LOWER COWL
- 88 LEFT SIDE COWL
- 90 FUEL TANK MAINTENANCE  
POSITION
- 92 HEADLIGHT AIM VERTICAL  
ADJUSTMENT

page

## **93 OPERATION**

- 93 PRE-RIDE INSPECTION
- 95 STARTING THE ENGINE
- 100 RUNNING-IN
- 101 RIDING
- 103 BRAKING
- 106 PARKING
- 107 ANTI-THEFT TIPS

# MAINTENANCE

page	
<b>108</b>	<b>MAINTENANCE</b>
108	THE IMPORTANCE OF MAINTENANCE
109	MAINTENANCE SAFETY
110	SAFETY PRECAUTIONS
111	MAINTENANCE SCHEDULE
114	TOOL KIT
115	SERIAL NUMBERS
116	COLOUR LABEL
117	ENGINE OIL
123	CRANKCASE BREATHER
125	SPARK PLUGS
128	THROTTLE OPERATION
129	IDLE SPEED
130	COOLANT
131	AIR CLEANER
132	DRIVE CHAIN
138	DRIVE CHAIN SLIDER
139	FRONT AND REAR SUSPENSION INSPECTION
140	SIDE STAND
141	WHEEL REMOVAL
147	BRAKE PAD WEAR

page	
149	BATTERY
152	FUSE REPLACEMENT
155	STOPLIGHT SWITCH ADJUSTMENT
156	BULB REPLACEMENT
<b>163</b>	<b>CLEANING</b>
<b>167</b>	<b>STORAGE GUIDE</b>
167	STORAGE
169	REMOVAL FROM STORAGE
<b>170</b>	<b>SPECIFICATIONS</b>
<b>174</b>	<b>CATALYTIC CONVERTERS</b>
<b>175</b>	<b>NOISE CONTROL SYSTEM (AUSTRALIA ONLY)</b>

# **MOTORCYCLE SAFETY**

## **IMPORTANT SAFETY INFORMATION**

Your motorcycle can provide many years of service and pleasure – if you take responsibility for your own safety and understand the challenges that you can meet on the road.

There is much that you can do to protect yourself when you ride. You'll find many helpful recommendations throughout this manual. Following are a few that we consider most important.

### **Always Wear a Helmet**

It's a proven fact: helmets significantly reduce the number and severity of head injuries. So always wear an approved motorcycle helmet and make sure your passenger does the same. We also recommend that you wear eye protection, sturdy boots, gloves, and other protective gear (page 2 ).

### **Make Yourself Easy to See**

Some drivers do not see motorcycles because they are not looking for them. To make yourself more visible, wear bright reflective clothing, position yourself so other drivers can see you, signal before turning or changing lanes, and use your horn when it will help others notice you.

### **Ride Within Your Limits**

Pushing the limits is another major cause of motorcycle accidents. Never ride beyond your personal abilities or faster than conditions warrant. Remember that alcohol, drugs, fatigue and inattention can significantly reduce your ability to make good judgements and ride safely.

### **Don't Drink and Ride**

Alcohol and riding don't mix. Even one drink can reduce your ability to respond to changing conditions, and your reaction time gets worse with every additional drink. So don't drink and ride, and don't let your friends drink and ride either.

### **Keep Your Bike in Safe Condition**

For safe riding, it's important to inspect your motorcycle before every ride and perform all recommended maintenance. Never exceed load limits, and only use accessories that have been approved by Honda for this motorcycle. See page 4 for more details.

### **PROTECTIVE APPAREL**

For your safety, we strongly recommend that you always wear an approved motorcycle helmet, eye protection, boots, gloves, long pants, and a long-sleeved shirt or jacket whenever you ride. Although complete protection is not possible, wearing proper gear can reduce the chance of injury when you ride.

Following are suggestions to help you choose proper gear.

#### **⚠ WARNING**

Not wearing a helmet increases the chance of serious injury or death in a crash.

Be sure you and your passenger always wear a helmet, eye protection and other protective apparel when you ride.

## **Helmets and Eye Protection**

Your helmet is your most important piece of riding gear because it offers the best protection against head injuries. A helmet should fit your head comfortably and securely. A bright-coloured helmet can make you more noticeable in traffic, as can reflective strips.

An open-face helmet offers some protection, but a full-face helmet offers more. Always wear a face shield or goggles to protect your eyes and help your vision.

## **Additional Riding Gear**

In addition to a helmet and eye protection, we also recommend:

- Sturdy boots with non-slip soles to help protect your feet and ankles.
- Leather gloves to keep your hands warm and help prevent blisters, cuts, burns and bruises.
- A motorcycle riding suit or jacket for comfort as well as protection. Bright-coloured and reflective clothing can help make you more noticeable in traffic. Be sure to avoid loose clothes that could get caught on any part of your motorcycle.

## **LOAD LIMITS AND GUIDELINES**

Your motorcycle has been designed to carry you and one passenger. When you carry a passenger, you may feel some difference during acceleration and braking. But so long as you keep your motorcycle well-maintained, with good tyres and brakes, you can safely carry loads within the given limits and guidelines.

However, exceeding the weight limit or carrying an unbalanced load can seriously affect your motorcycle's handling, braking and stability. Non-Honda accessories, improper modifications, and poor maintenance can also reduce your safety margin.

The following pages give more specific information on loading, accessories and modifications.

## **Loading**

How much weight you put on your motorcycle, and how you load it, are important to your safety. Anytime you ride with a passenger or cargo you should be aware of the following information.

### **⚠ WARNING**

Overloading or improper loading can cause a crash and you can be seriously hurt or killed.

Follow all load limits and other loading guidelines in this manual.



## Load Limits

Following are the load limits for your motorcycle:

### **Maximum weight capacity:**

188 kg (414 lbs)

Includes the weight of the rider, passenger, all cargo and all accessories

### **Maximum cargo weight:**

27 kg (60 lbs)

Putting too much weight in individual storage compartments can also affect stability and handling. So be sure to stay within the limits given below:

### **Maximum weight:**

**in right pocket**

0.5 kg (1.1 lbs)

**in left pocket**

0.5 kg (1.1 lbs)

The weight of added accessories will reduce the maximum cargo weight you can carry.

## Loading Guidelines

Your motorcycle is primarily intended for transporting you and a passenger. You may wish to secure a jacket or other small items to the seat when you are not riding with a passenger.

If you wish to carry more cargo, check with your Honda dealer for advice, and be sure to read the information regarding accessories on page 6.

Improperly loading your motorcycle can affect its stability and handling. Even if your motorcycle is properly loaded, you should ride at reduced speeds and never exceed 130 km/h (80 mph) when carrying cargo.

Follow these guidelines whenever you carry a passenger or cargo:

- Check that both tyres are properly inflated.
- If you change your normal load, you may need to adjust the front suspension (page 47 ) and the rear suspension (page 49 ).
- To prevent loose items from creating a hazard, make sure that all cargo is securely tied down before you ride away.
- Place cargo weight as close to the center of the motorcycle as possible.
- Balance cargo weight evenly on both sides.

## Accessories and Modifications

Modifying your motorcycle or using non-Honda accessories can make your motorcycle unsafe. Before you consider making any modifications or adding an accessory, be sure to read the following information.

### **WARNING**

Improper accessories or modifications can cause a crash in which you can be seriously hurt or killed.

Follow all instructions in this owner's manual regarding accessories and modifications.

## **Accessories**

We strongly recommend that you use only genuine Honda accessories that have been specifically designed and tested for your motorcycle. Because Honda cannot test all other accessories, you must be personally responsible for proper selection, installation and use of non-Honda accessories. Check with your dealer for assistance and always follow these guidelines:

- Make sure the accessory does not reduce ground clearance and lean angle, limit suspension travel or steering travel, alter your riding position or interfere with operating any controls.
- Be sure electrical equipment does not exceed the motorcycle's electrical system capacity (page 173 ). A blown fuse can cause a loss of lights or engine power.

- Do not pull a trailer or sidecar with your motorcycle. This motorcycle was not designed for these attachments, and their use can seriously impair your motorcycle's handling.

## **Modifications**

We strongly advise you not to remove any original equipment or modify your motorcycle in any way that would change its design or operation. Such changes could seriously impair your motorcycle's handling, stability and braking, making it unsafe to ride.

Removing or modifying your lights, mufflers, emission control system or other equipment can also make your motorcycle illegal.

# PARTS LOCATION

## CB1300S/SA

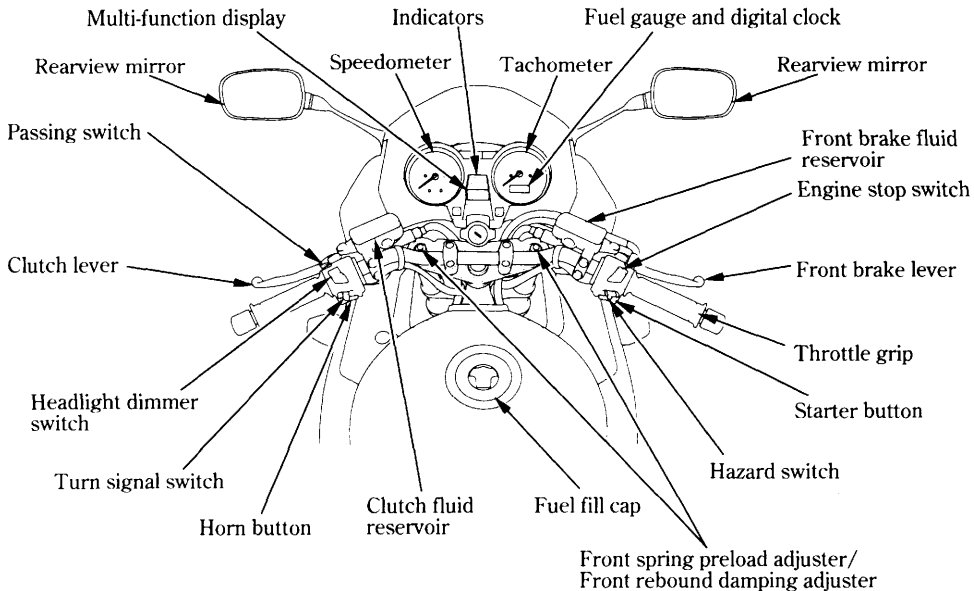

# PARTS LOCATION

## CB1300/A

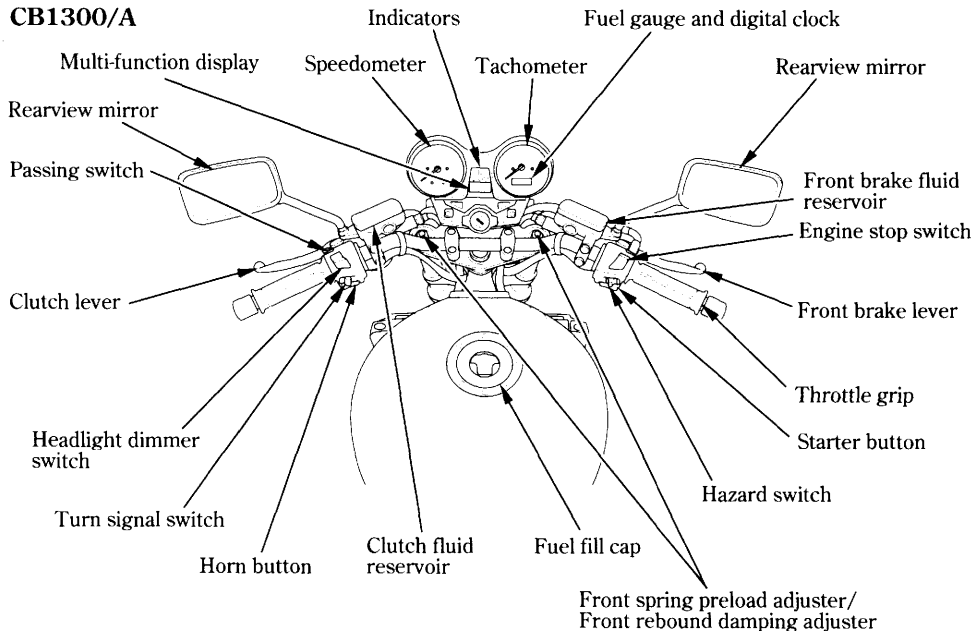

## CB1300S/SA

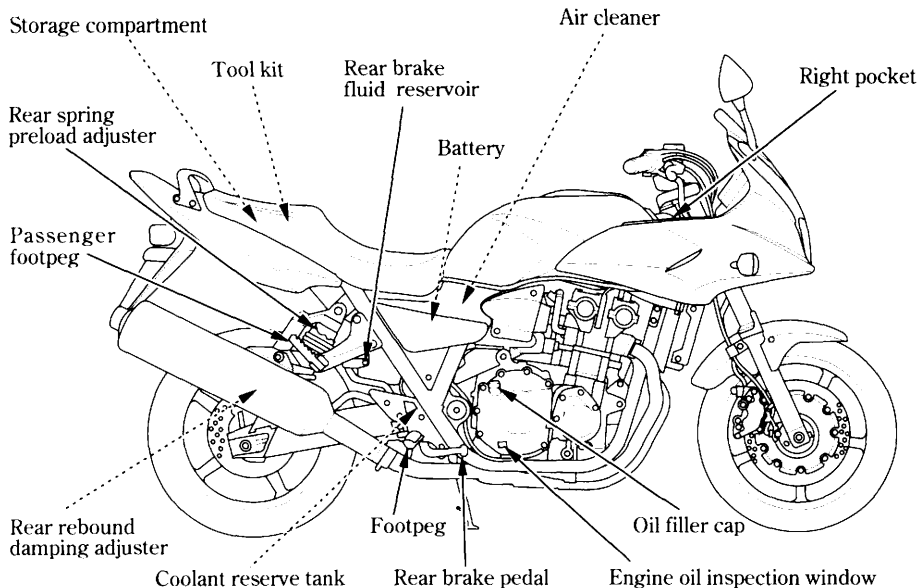

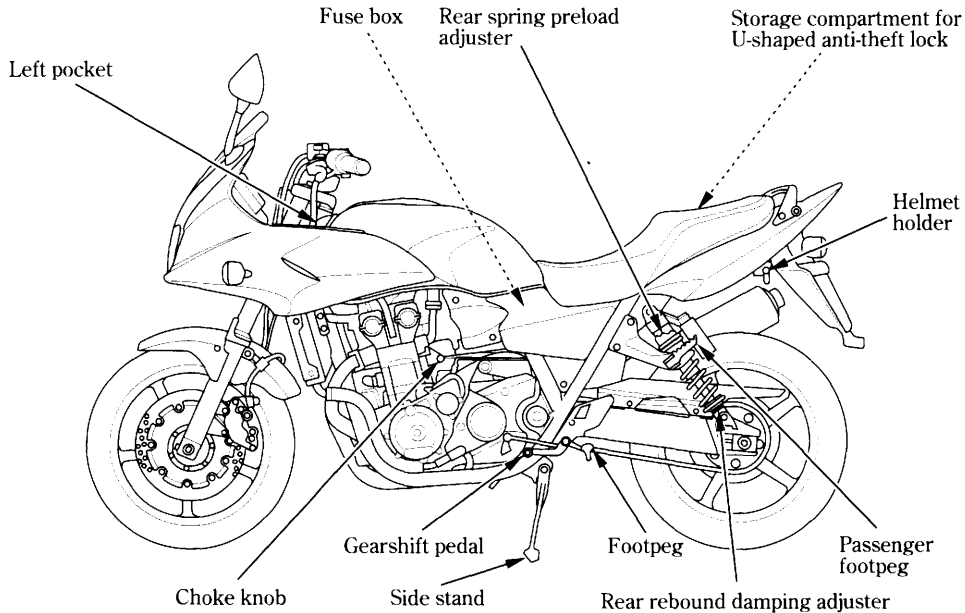

## CB1300/A

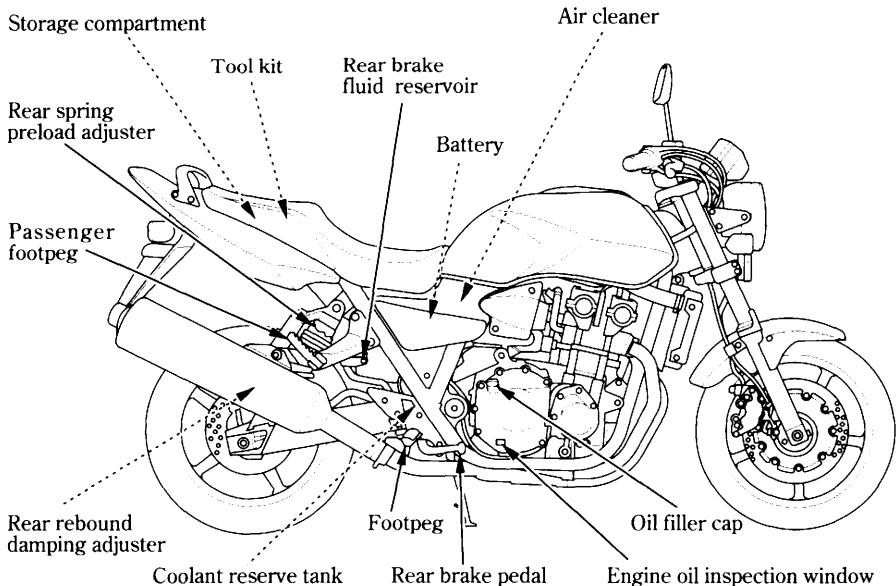



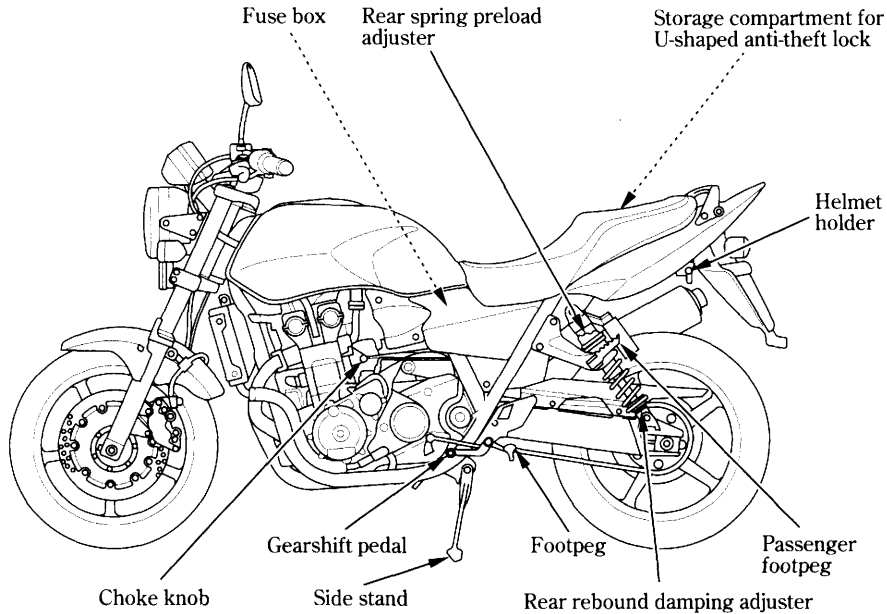

## INSTRUMENTS AND INDICATORS CB1300S/SA

The indicators are contained in the instrument panel. Their functions are described in the tables on the following pages.

- (1) Tachometer
- (2) Tachometer red zone
- (3) Fuel gauge and Digital clock
- (4) Right turn signal indicator
- (5) Right control button
- (6) Left turn signal indicator
- (7) Left control button
- (8) Multi-function display
- (9) Immobilizer system (HISS) indicator
- (10) Anti-lock brake system (ABS) indicator (CB1300SA)
- (11) Speedo meter
- (12) PGM-FI indicator
- (13) Low oil pressure indicator
- (14) Neutral indicator
- (15) High beam indicator
- (16) Coolant temperature indicator

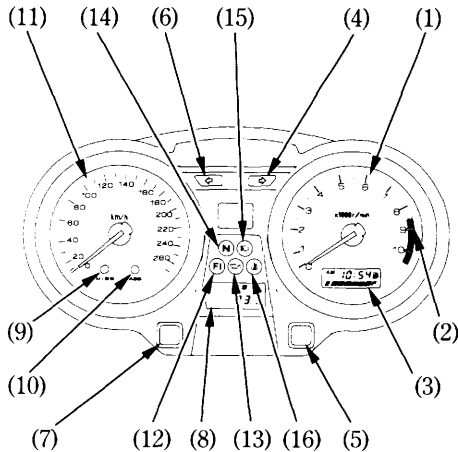

## CB1300/A

The indicators are contained in the instrument panel. Their functions are described in the tables on the following pages.

- (1) Tachometer
- (2) Tachometer red zone
- (3) Fuel gauge and Digital clock
- (4) Right turn signal indicator
- (5) Right control button
- (6) Left turn signal indicator
- (7) Left control button
- (8) Multi-function display
- (9) Immobilizer system (HISS) indicator
- (10) Anti-lock brake system (ABS) indicator (CB1300A)
- (11) Speedo meter
- (12) PGM-FI indicator
- (13) Low oil pressure indicator
- (14) Neutral indicator
- (15) High beam indicator
- (16) Coolant temperature indicator

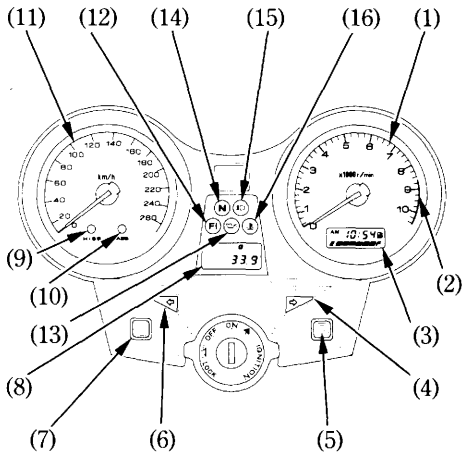

<b>(Ref.No.) Description</b>	<b>Function</b>
(1) Tachometer	Shows engine revolutions per minute. The tachometer needle will swing to the maximum scale on the dial once when the ignition switch is turned ON.
(2) Tachometer red zone	Never allow the tachometer needle to enter the red zone, even after the engine has been broken in.  <b>NOTICE</b> Running the engine beyond recommended maximum engine speed (the beginning of the tachometer red zone) can damage the engine.
(3) Fuel gauge and digital clock	Shows approximate fuel supply available (page 43 ). Shows hour and minute (page 45 ).

<b>(Ref.No.) Description</b>	<b>Function</b>
(4) Right turn signal indicator (green)	Flashes when the right turn signal operates.
(5) Right control button	Use this button for the following purposes. <ul style="list-style-type: none"> <li>• To select display mode</li> <li>• To start and pause the stopwatch</li> <li>• To set the scheduled date</li> <li>• To set mileage countdown</li> </ul>

<b>(Ref.No.) Description</b>	<b>Function</b>
(6) Left turn signal indicator (green)	Flashes when the left turn signal operates.
(7) Left control button	Use this button for the following purposes. <ul style="list-style-type: none"> <li>• To adjust time</li> <li>• To select display mode</li> <li>• To reset tripmeter</li> <li>• To set the scheduled date</li> <li>• To set mileage countdown</li> <li>• To switch blinking of the immobilizer system (HISS) indicator</li> </ul>

<b>(Ref.No.) Description</b>	<b>Function</b>
(8) Multi-function display (Display mode 1)	The display includes the following functions; This display shows the initial display (page 25 ).
Odometer	Shows accumulated mileage (page 27 ).
Tripmeter 1 and 2	Shows mileage per trip (page 27 ).
Air temperature meter	Shows air temperature (page 29 ).
Coolant temperature meter	Shows coolant temperature (page 30 ).

<b>(Ref.No.) Description</b>	<b>Function</b>
(8) Multi-function display (Display mode 2)	The display includes the following functions; This display shows the initial display (page 25 ).
DAYS	Shows scheduled date (page 32 ).
Stopwatch	Shows stopwatch (page 35 ).
Mileage Countdown	Shows subtraction mileage (page 37 ).
TODAY	Shows the current days and mileage (page 40 ).



<b>(Ref.No.) Description</b>	<b>Function</b>
(9) Immobilizer system (HISS) indicator (red)	<p>This indicator lights for a few seconds when the ignition switch is turned ON and the engine stop switch is at  (RUN). It will then go off if the properly-coded key has been inserted. If an improperly-coded key has been inserted, the indicator will remain on and the engine will not start (page 72 ).</p> <p>When the blinking function of this indicator is valid and the ignition switch is OFF, it keeps blinking for 24 hours (page 73 ).</p>
(10) Anti-lock brake system (ABS) indicator (red) (1300A/SA)	<p>This light normally comes on when the ignition is turned ON, and goes off after you ride the motorcycle at speed above 10 km/h (6 mph). If there is a problem with the Anti-lock Brake System, this light flashes and remains on (see page 104).</p>

<b>(Ref.No.) Description</b>	<b>Function</b>
(11) Speedometer	<p>Shows riding speed.</p> <p>This shows your speed in kilometers per hour (km/h) and/or miles per hour (mph) depending on the type.</p> <p>The speedometer needle will swing to the maximum scale on the dial once when the ignition switch is turned ON.</p>
(12) PGM-FI indicator (red)	<p>Lights when there is any abnormality in the PGM-FI (Programmed Fuel Injection) system. Should also light for a few seconds and then go off when the ignition switch is turned ON and engine stop switch is at ○ (RUN).</p> <p>If it comes on at any other time, reduce speed and take the motorcycle to your Honda dealer as soon as possible.</p>

<b>(Ref.No.) Description</b>	<b>Function</b>
(13) Low oil pressure indicator (red)	<p>Lights when the engine oil pressure is below normal operating range. Should light when ignition switch is ON and engine is not running. Should go out when the engine starts, except for occasional flickering at or near idling speed when engine is warm.</p> <p><b>NOTICE</b></p> <p>Running the engine with insufficient oil pressure may cause serious engine damage.</p>
(14) Neutral indicator (green)	Lights when the transmission is in neutral.
(15) High beam indicator (blue)	Lights when the headlight is on high beam.

<b>(Ref.No.) Description</b>	<b>Function</b>
(16) Coolant temperature indicator (red)	<p>Lights when the coolant is over the specified temperature. If the indicator goes on while riding, stop the engine and check the reserve tank coolant level. Read pages 57 – 58 and do not ride the motorcycle until the problem has been corrected.</p> <p><b>NOTICE</b></p> <p>Exceeding maximum running temperature may cause serious engine damage.</p>

### Initial Display

When the ignition switch is turned ON, the display will temporarily show all the modes and digital segments so you can make sure the liquid crystal display is functioning properly.

The digital clock, tripmeter, DAYS and TODAY will reset if the battery is disconnected.

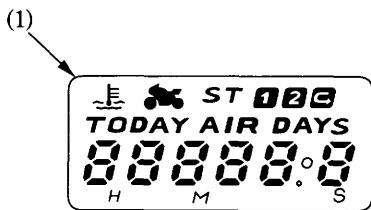

- (1) Multi-function display
- (2) Fuel gauge and digital clock

## Multi-function Display

There are two display modes: display mode 1 and display mode 2.

Multi-function display mode 1 includes the following functions:

Odometer

Tripmeter

Air temperature meter

Coolant temperature meter

Multi-function display mode 2 includes the following functions:

DAYS

Stopwatch

Mileage countdown

TODAY

To switch between the display mode 1 and display mode 2, while press and hold the left control button (2), then press and hold the right control button (3) for more than 2 seconds.

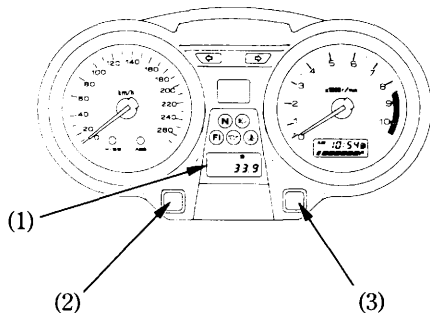

- (1) Multi-function display
- (2) Left control button
- (3) Right control button

### Odometer/Tripmeter/Air Temperature Meter/Coolant temperature meter (display mode 1)

The Display mode 1 has four functions: odometer, tripmeter, Air temperature meter and coolant temperature.

Press the left control button (1) to select "ODO" (Odometer), "TRIP 1" (Tripmeter 1), "TRIP 2" (Tripmeter 2), "Air temperature meter" and "TEMP" (Coolant temperature) mode.

ED/EK/F/U model: Odometer and tripmeter read in kilometers.

E model: Odometer and tripmeter read in miles.

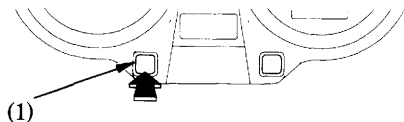

(1) Left control button

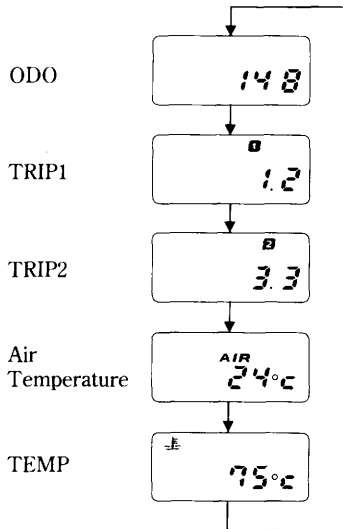

To reset the tripmeter, press and hold the left control button for more than 2 seconds when the display is in the "TRIP" mode.

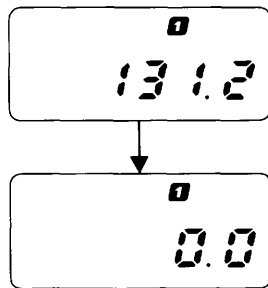



## Air Temperature Meter

Air temperature meter (1) shows air temperature digitally.

To select the Air temperature mode, push the left control button (2).

## Temperature Display

Below $-10^{\circ}\text{C}$	"--" is displayed.
Between $-10^{\circ}\text{C}$ and $50^{\circ}\text{C}$	Actual air temperature is indicated.
Above $50^{\circ}\text{C}$	The display will remain " $50^{\circ}\text{C}$ ".

The temperature sensor is located in the meter. Therefore, the temperature reading can be affected by heat reflection from the road surface, engine heat, and the exhaust from the surrounding traffic. This can cause the temperature reading not to be correct when your speed is under 30 km/h (19 mph).

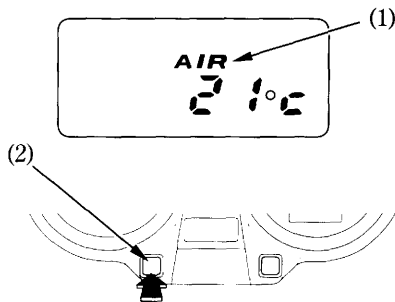

- (1) Air temperature meter
- (2) Left control button

## Coolant Temperature Meter

The coolant temperature meter (1) shows coolant temperature digitally.

### Temperature Display

Below 34°C	"— —" is displayed.
Between 35°C and 131°C	Actual coolant temperature is indicated.
Above 132°C	The display will remain "132°C".

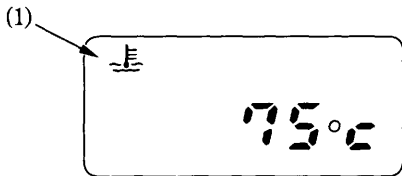

(1) Coolant temperature meter

## Overheating Message

When the coolant temperature reaches 122°C, the display begins to flash and coolant temperature indicator (2) goes on. If this occurs, stop the engine and check the reserve tank coolant level. Read pages 57 — 58 and do not ride the motorcycle until the problem has been corrected.

### NOTICE

Exceeding maximum running temperature may cause serious engine damage.

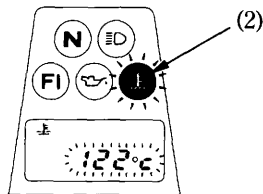

(2) Coolant temperature indicator

## DAYS/Stopwatch/Mileage Countdown/ TODAY (display mode 2)

The display mode 2 has four functions:  
DAYS, Stopwatch, Mileage countdown and  
TODAY.

Push the left control button (1) to select  
“DAYS”, “Stopwatch”, “Mileage countdown”  
and “TODAY”.

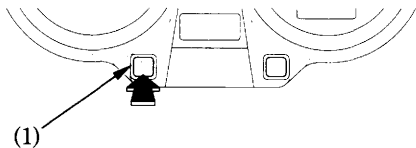

(1) Left control button

DAYS

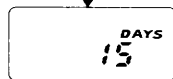

Stopwatch



Mileage  
countdown

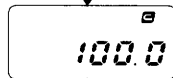

TODAY

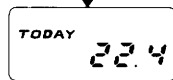

## DAYS

DAYS allows you to countdown to a scheduled date in the future.

There are three display mode,

### Until the scheduled date:

- The days until the scheduled date is displayed.

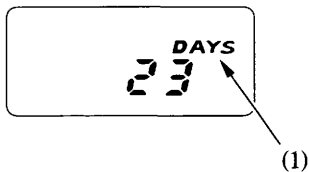

- (1) DAYS display  
(2) Icon mark

### Scheduled date or passed the scheduled date:

- "0" is displayed and Icon mark (2) will light.

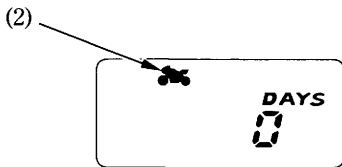

### No setting:

- " - - - - - " is displayed.

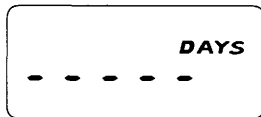

To set scheduled date:

1. Turn the ignition switch ON.
2. Select the DAYS mode.
3. Press the left control button (1) for more than 2 seconds. The display will be set in the adjustment mode with the year display flashing.

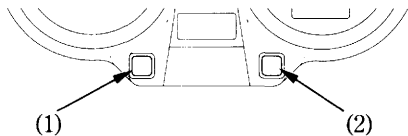
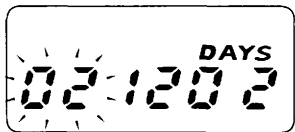

- (1) Left control button
- (2) Right control button

4. To set the year, press the right control button (2) until the desired year appears.
  - Quick setting – press and hold the right control button until the desired year appears.
  - If setting “-” while adjusting year, scheduled date is not set.
5. Press the left control button when the display reaches the desired year. The month display will be flashing.

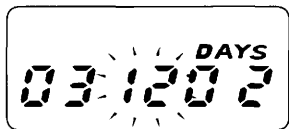

6. Repeat steps 4 and 5 for the month and day.

If the ignition switch is turned off or no operation is performed for 5 seconds during the adjustment mode, the set date will reset.

When the battery terminal is disconnected:

- If the scheduled date has been set, "0" will be flashing and the Icon mark will be lit.
- If the scheduled date is not set, " - - - - " will be displayed.

## Stopwatch

The stopwatch will count hours, minutes and seconds.

### Stopwatch measurement range:

After measuring 9 hours, 59 minutes, 59.9 seconds, it returns to 0 hours, 0 minutes, 00.0 seconds and will continue counting.

(1)

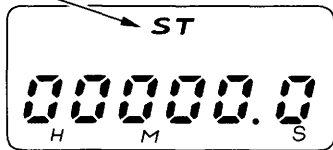

- (1) Stopwatch
- (2) Right control button

## How to measure time

1. Select the stopwatch mode.
2. To measure, push the right (2) control button. While measuring, push the right control button to pause and push it again to resume.

START



(2)

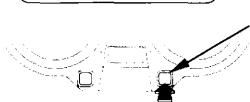

PAUSE



Stopwatch RESET:

Press and hold the left control button (1) for more than 2 seconds when the stopwatch is paused.

PAUSE



RESET

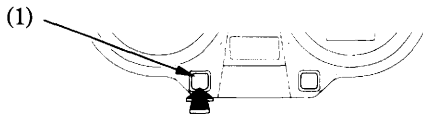

(1) Left control button



## Mileage Countdown

In this mode, the mileage will be subtracted from the preset figure. When the mileage exceeds the preset figure, the numeric will flash.

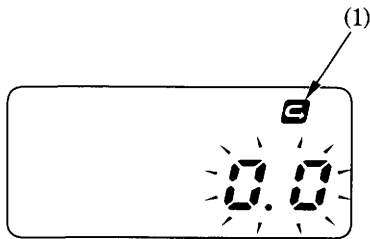

## How to set distance:

1. Turn the ignition switch ON.
2. Select the mileage countdown.
3. Press and hold the left control button (2) for more than 2 seconds.
  - Display will change to the set distance mode or reset to the initial setting. See following Example page.

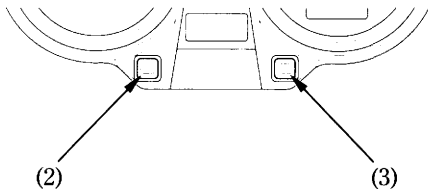

- (1) Mileage countdown display
- (2) Left control button
- (3) Right control button

## Example

- If you set the trip mileage, then reset before completing the set distance, the subtraction trip mode will reset to the initial setting.
- If you set the subtraction trip mode and do not travel, you will have to re-enter the trip distance.

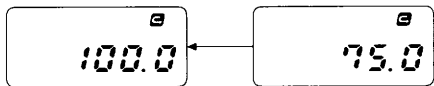

Reset to the initial setting.

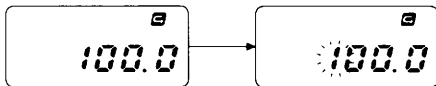

Change to the set distance mode.

4. The preset figure is displayed and the third digit will be flashing.

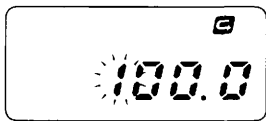

5. To set the third digit, press the right control button (3) until the desired third digit appears.
- Quick setting – press and hold the right control button until the desired third digit appears.

6. Press the left control button when the display reaches the desired figure. The second digit will be flashing.

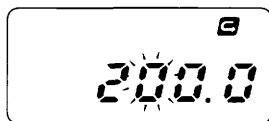

7. Repeat steps 5 and 6 for the second and first digits.

If the ignition switch is turned off or no operation is performed for 5 seconds during the adjustment mode, the set digits will reset.

## TODAY

Shows the present date for 5 seconds and then shows today's mileage.

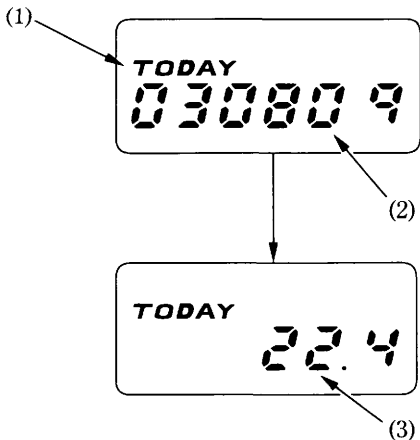

## How to set date:

1. Turn the ignition switch ON.
2. Select the TODAY mode.
3. During the present date display displayed (for 5 seconds), press and hold the right control button (4) for more than 2 seconds.

The year display will be flashing.

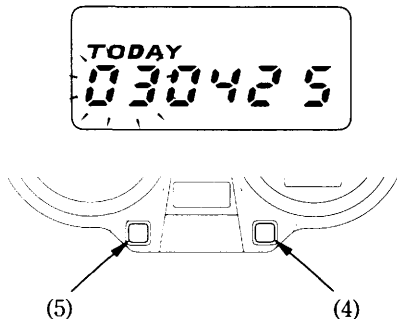

- To set the year, press the right control button (4) until the desired year appears.
  - Quick setting – press and hold the right control button until the desired year appears.
- Press the left control button when the display reaches the desired year.  
The month display will be flashing.

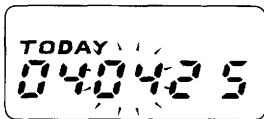

- Repeat steps 5 and 6 for the month and day.

- After finishing the data setting, change over to digital clock setting mode. To set the digital clock. See page 45 .

If the ignition switch is turned off or no operation is performed for 5 seconds during the adjustment mode, the set date will reset.

The mileage will reset to "0.0" and the present date will reset to "000101 AM 1:00" if the battery terminal is disconnected.

### Fuel gauge and digital clock

The fuel gauge and digital clock display (1) includes the fuel gauge liquid crystal display (2) and the digital clock (3).

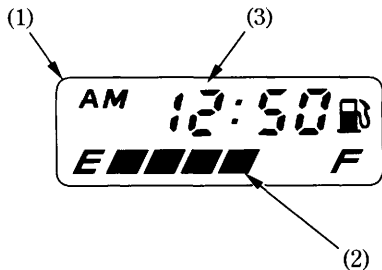

- (1) Fuel gauge and digital clock
- (2) Fuel gauge display
- (3) Digital clock

## Fuel Gauge

The fuel gauge liquid crystal display (1) shows the approximate fuel supply available in a graduated display. When the segment F (2) goes on, the fuel tank capacity including reserve is:

21.0 ℓ (5.55 US gal , 4.62 Imp gal)

When the display flashes as shown in the illustration, fuel will be low and you should refill the tank as soon as possible.

The amount of fuel left in the tank with the vehicle set upright is approximately:

4.0 ℓ (1.06 US gal , 0.88 Imp gal)

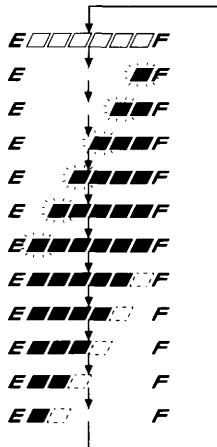
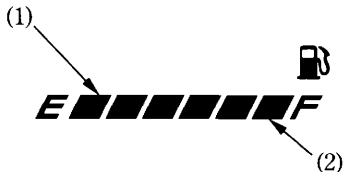

- (1) Fuel gauge display
- (2) Segment F

Fuel Gauge Failure Indication:

If the fuel system has an error, the fuel gauge indicators will be displayed as shown in the illustration.

If this occurs, see your Honda dealer as soon as possible.

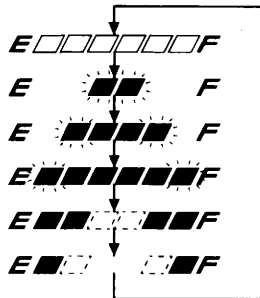



## Digital Clock

The digital clock will show hours and minutes up to 12:59 with “AM” and “PM”.

To adjust the time, proceed as follows:

1. Turn the ignition switch ON.
2. Press and hold the right control button (1) for more than 2 seconds. The clock will be set in the adjust mode with the display flashing.
  - When TODAY present date or Stopwatch is displayed, adjust mode can not be selected.

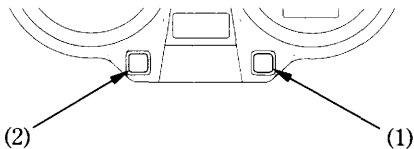

- (1) Right control button  
(2) Left control button



3. To set the hour, press the right control button until the desired hour and AM/PM are displayed.
  - Quick setting – press and hold the right control button until the desired hour appears.
4. Press the left control button (2) when the display reaches the desired hour appears.  
The minute display will be flashing.

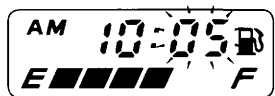

5. To set the minute, press the right control button until the desired minute appears.
  - Quick setting – press and hold the right control button until the desired minute appears.
6. Press the left control button when the display reaches the desired minute appears.

The display will stop flashing.

If the ignition switch is turned off or no operation is performed for 5 seconds during the time adjustment mode, the clock will reset.

The clock will be reset AM 1:00 if the battery is disconnected.

# MAJOR COMPONENTS

## (Information you need to operate this motorcycle)

### SUSPENSION

#### Front Suspension

##### Spring Preload:

Adjust the spring preload by turning the preload adjuster (1) with the 14 × 17 mm wrench provided in the tool kit.

Make sure that both fork legs are adjusted to the same position.

To reduce (SOFT) :

Turn the adjuster counterclockwise toward SOFT for a light load and smooth road condition.

To increase (HARD) :

Turn the adjuster clockwise toward HARD for a firmer ride and rough road condition.

##### Standard Position:

To return to the standard position, turn the adjusters until the fourth groove from the top aligns with the top surface of the fork caps.

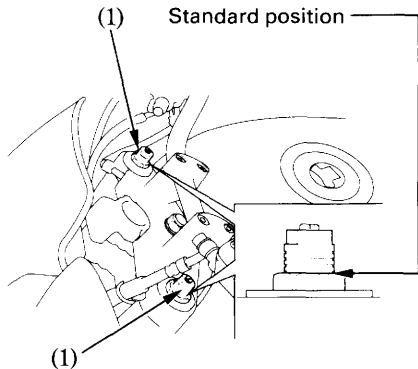

(1) Preload adjuster

### Rebound Damping:

To reduce (SOFT) :

Turn the adjuster counterclockwise toward SOFT for a light load and smooth road condition.

To increase (HARD) :

Turn the adjuster clockwise toward HARD for a firmer ride and rough road condition.

To adjust the adjuster to the standard position, proceed as follows :

1. Turn the damping adjuster (1) clockwise until it will no longer turn (lightly seats). This is the full hard setting.
2. The adjuster is set in the standard position when the adjuster is turned counterclockwise 1.5 turns.
3. Make sure that both fork legs are adjusted to the same position.

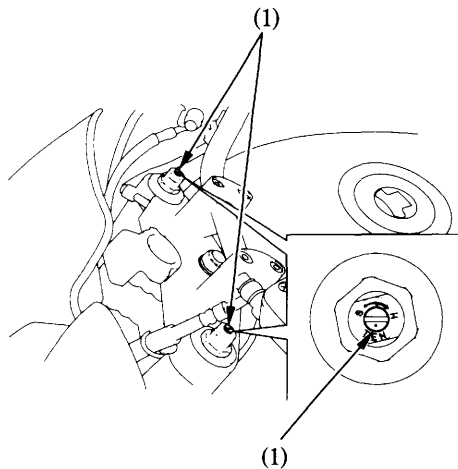

(1) Damping adjuster

## Rear Suspension

### Rebound Damping:

To reduce (SOFT) :

Turn the adjuster toward SOFT (S) for a light load and smooth road condition.

To increase (HARD) :

Turn the adjuster toward HARD (H) for a firmer ride and rough road condition.

To adjust the adjuster to the standard position, proceed as follows :

1. Turn the damping adjuster (1) counter-clockwise until it will no longer turn. This is the full hard setting.
2. The adjuster is set in the standard position when the adjuster is turned clockwise approximately 10 clicks.

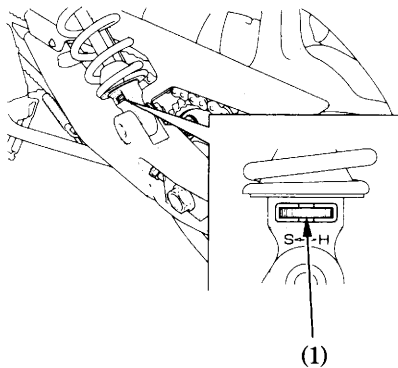

(1) Damping adjuster

### Spring Preload:

The spring preload adjuster (1) has 5 spring preload positions for different load or riding conditions.

Use the pin spanner (2) and extension bar (3) to adjust the rear shock.

Position 1 is for a light load and smooth road conditions. Position 2 is the standard position. Positions 3 to 5 increase spring preload for a stiffer rear suspension and can be used when the motorcycle is more heavily loaded.

The rear shock absorber assembly includes a damper unit that contains high pressure nitrogen gas. Do not attempt to disassemble or service the damper; it cannot be rebuilt and must be replaced when worn out. Disposal should only be done by your Honda dealer. The instructions found in this owner's manual are limited to adjustment of the shock assembly only.

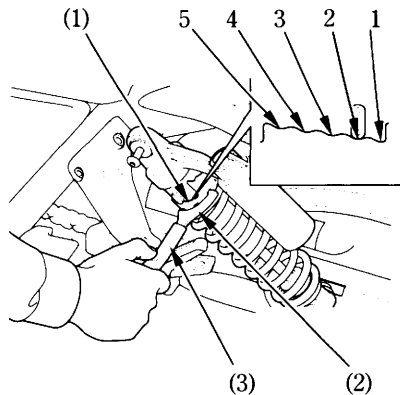

- (1) Spring adjuster
- (2) Pin spanner

- (3) Extension bar

## **HANDLEBAR POSITION**

### **CB1300/A**

The handlebar position can be adjusted according to rider preference.

It should be serviced by your Honda dealer.

## **BRAKES**

Both the front and rear brakes are the hydraulic disc types.

As the brake pads wear, the brake fluid level drops.

There are no adjustments to perform, but fluid level and pad wear must be inspected periodically. The system must be inspected frequently to ensure there are no fluid leaks. If the control lever or pedal free travel becomes excessive and the brake pads are not worn beyond the recommended limit (page 147 ), there is probably air in the brake system and it must be bled. See your Honda dealer for this service.

### Front Brake Fluid Level:

With the motorcycle in an upright position, check the fluid level. It should be above the LOWER level mark (1). If the level is at or below the LOWER level mark (1), check the brake pads for wear (page 147 ).

Worn pads should be replaced. If the pads are not worn, have your brake system inspected for leaks.

The recommended brake fluid is Honda DOT 4 brake fluid from a sealed container, or an equivalent.

### **Front**

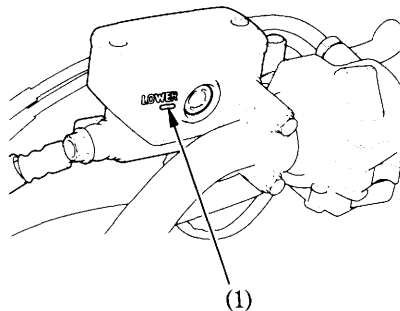

(1) LOWER level mark



### Front Brake Lever:

The distance between the tip of the brake lever (1) and the grip can be adjusted by turning the adjuster dial (2) while pushing the lever forward.

Align the numbers (3) on the adjuster dial with the index mark (4).

Apply the brake several times and check for free wheel rotation after the brake lever is released.

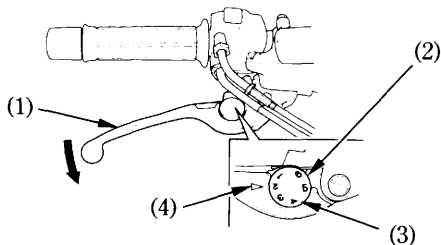

- (1) Brake lever
- (2) Adjuster dial

- (3) Numbers
- (4) Index mark

### Other Checks:

Make sure there are no fluid leaks. Check for deterioration or cracks in the hoses and fittings.

### Rear Brake Fluid Level:

With the motorcycle in an upright position, check the fluid level. It should be between the UPPER (1) and LOWER (2) level marks. If the level is at or below the LOWER level mark (2), check the brake pads for wear (page 138 ).

Worn pads should be replaced. If the pads are not worn, have your brake system inspected for leaks.

The recommended brake fluid is Honda DOT 4 brake fluid from a sealed container, or an equivalent.

**Rear**

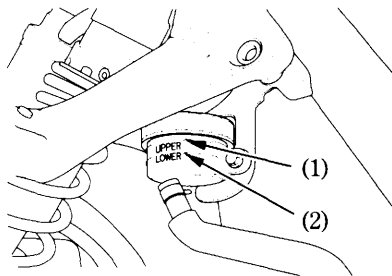

- (1) UPPER level mark
- (2) LOWER level mark

## **CLUTCH**

This motorcycle has a hydraulically actuated clutch. There are no adjustments to perform, but the clutch system must be inspected periodically for fluid level and leakage.

If the control lever freeplay becomes excessive and the motorcycle creeps or stalls when shifted into gear, or if the clutch slips, causing acceleration to lag behind engine speed, there is probably air in the clutch system and it must be bled out. See your Honda dealer for this service.

### **Fluid Level:**

Check that the fluid level is above the LOWER level mark (1) with the motorcycle in an upright position. If the fluid level is near the lower level line, it indicates fluid leakage. See your Honda dealer.

### **Other Checks:**

Make sure there are no fluid leaks. Check for deterioration or cracks in the hoses and fittings.

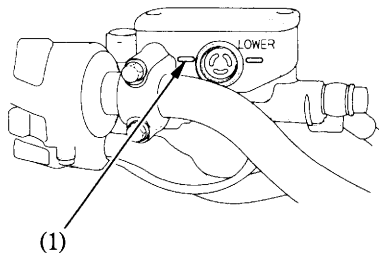

(1) LOWER level mark

### Clutch Lever:

The distance between the tip of the clutch lever (1) and the grip can be adjusted by turning the adjuster dial (2).

Turn the adjuster dial while pushing the clutch lever forward.

Align the numbers (3) on the adjuster dial with index mark (4).

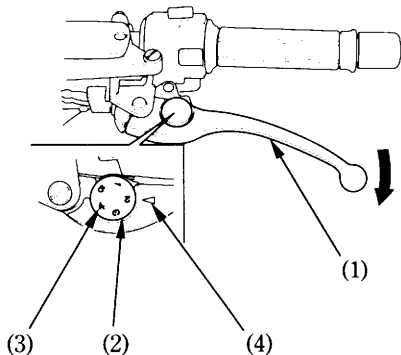

(1) Clutch lever  
(2) Adjuster dial

(3) Numbers  
(4) Index mark

## **COOLANT**

### **Coolant Recommendation**

The owner must properly maintain the coolant to prevent freezing, overheating, and corrosion. Use only high quality ethylene glycol antifreeze containing corrosion protection inhibitors specifically recommended for use in aluminum engines. (SEE ANTIFREEZE CONTAINER LABEL).

Use only low-mineral drinking water or distilled water as a part of the antifreeze solution. Water that is high in mineral content or salt may be harmful to the aluminum engine.

Using coolant with silicate inhibitors may cause premature wear of water pump seals or blockage of radiator passages.

Using tap water may cause engine damage.

The factory provides a 50/50 solution of antifreeze and distilled water in this motorcycle. This coolant solution is recommended for most operating temperatures and provides good corrosion protection. A higher concentration of antifreeze decreases the cooling system performance and is recommended only when additional protection against freezing is needed. A concentration of less than 40/60 (40% antifreeze) will not provide proper corrosion protection. During freezing temperatures, check the cooling system frequently and add higher concentrations of antifreeze (up to a maximum of 60% antifreeze) if required.

## Inspection

The reserve tank is behind the frame.

Check the coolant level in the reserve tank (1) while the engine is at the normal operating temperature with the motorcycle in an upright position. If the coolant level is below the LOWER level mark (2), remove the reserve tank cap (3) and add coolant mixture until it reaches the UPPER level mark (4). Always add coolant to the reserve tank.

Do not attempt to add coolant by removing the radiator cap.

If the reserve tank is empty, or if coolant loss is excessive, check for leaks and see your Honda dealer for repair.

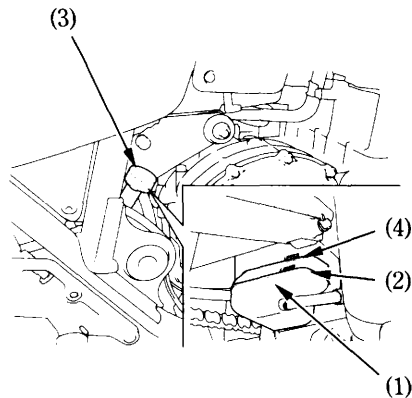

- (1) Reserve tank
- (2) LOWER level mark
- (3) Reserve tank cap
- (4) UPPER level mark

## FUEL

### Fuel Tank

The fuel tank capacity including the reserve supply is:

21.0 l (5.55 US gal , 4.62 Imp gal)

To open the fuel fill cap (1), insert the ignition key (2) and turn it clockwise. The fuel fill cap is hinged and will lift up.

Do not overfill the tank. There should be no fuel in the filler neck (3).

After refueling, to close the fuel fill cap, push the fuel fill cap into the filler neck until it snaps closed and locks. Remove the key.

## **⚠ WARNING**

Petrol is highly flammable and explosive. You can be burned or seriously injured when handling fuel.

- Stop the engine and keep heat, sparks, and flame away.
- Refuel only outdoors.
- Wipe up spills immediately.

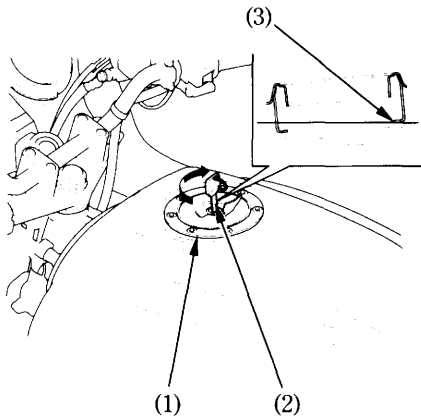

- (1) Fuel fill cap  
(2) Ignition key

(3) Filler neck

Use unleaded petrol with a research octane number of 91 or higher.

The use of leaded petrol will cause premature damage to the catalytic converter.

#### **NOTICE**

If “spark knock” or “pinking” occurs at a steady engine speed under normal load, change brands of petrol. If spark knock or pinking persists, consult your Honda dealer. Failure to do so is considered misuse, and damage caused by misuse is not covered by Honda’s Limited Warranty.



## **Petrol Containing Alcohol**

If you decide to use a petrol containing alcohol (gasohol), be sure it's octane rating is at least as high as that recommended by Honda. There are two types of "gasohol": one containing ethanol, and the other containing methanol. Do not use petrol that contains more than 10 % ethanol. Do not use petrol containing methanol (methyl or wood alcohol) that does not also contain cosolvents and corrosion inhibitors for methanol. Never use petrol containing more than 5 % methanol, even if it has cosolvents and corrosion inhibitors.

Fuel system damage or engine performance problems resulting from the use of fuels that contain alcohol is not covered under the warranty. Honda cannot endorse the use of fuels containing methanol since evidence of their suitability is as yet incomplete.

Before buying fuel from an unfamiliar station, try to find out if the fuel contains alcohol. If it does, confirm the type and percentage of alcohol used. If you notice any undesirable operating symptoms while using a petrol that contains alcohol, or one that you think contains alcohol, switch to a petrol that you know does not contain alcohol.

## ENGINE OIL

### Engine Oil Level Check

Check the engine oil level each day before riding the motorcycle.

The level must be maintained between the upper (1) and lower (2) level marks in the inspection window (3).

1. Start the engine and let it idle for 3–5 minutes. Make sure the low oil pressure indicator goes off. If the indicator light remains on, stop the engine immediately.
2. Stop the engine and hold the motorcycle in an upright position on firm, level ground.
3. After a few minutes, check that the oil level is between the upper (1) and lower (2) level marks in the inspection window (3).
  - If required, clean the inspection window by turning the wiper (4).

4. If required, remove the oil filler cap (5) and add the specified oil (page 117) up to the upper level mark. Do not overfill.
5. Reinstall the oil filler cap. Check for oil leaks.

### NOTICE

Running the engine with insufficient oil pressure may cause serious engine damage.

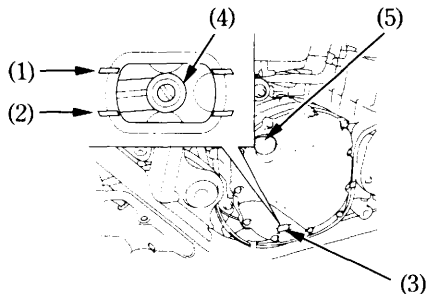

- |                       |                    |
|-----------------------|--------------------|
| (1) UPPER level mark  | (4) Wiper          |
| (2) LOWER level mark  | (5) Oil filler cap |
| (3) Inspection window |                    |

## TUBELESS TYRES

To safely operate your motorcycle, your tyres must be the proper type and size, in good condition with adequate tread, and correctly inflated for the load you are carrying. The following pages give more detailed information on how and when to check your air pressure, how to inspect your tyres for damage, and what to do when your tyres need to be repaired or replaced.

### **WARNING**

Using tyres that are excessively worn or improperly inflated can cause a crash in which you can be seriously hurt or killed.

Follow all instructions in this owner's manual regarding tyre inflation and maintenance.

## Air Pressure

Keeping your tyres properly inflated provides the best combination of handling, tread life and riding comfort. Generally, underinflated tyres wear unevenly, adversely affect handling, and are more likely to fail from being overheated.

Overinflated tyres make your motorcycle ride more harshly, are more prone to damage from road hazards, and wear unevenly.

We recommend that you visually check your tyres before every ride and use a gauge to measure air pressure at least once a month or any time you think the tyres might be low.

Tubeless tyres have some self-sealing ability if they are punctured. However, because leakage is often very slow, you should look closely for punctures whenever a tyre is not fully inflated.

Always check air pressure when your tyres are “cold” – when the motorcycle has been parked for at least three hours. If you check air pressure when your tyres are “warm” – when the motorcycle has been ridden for even a few miles – the readings will be higher than if the tyres were “cold”. This is normal, so do not let air out of the tyres to match the recommended cold air pressures given below. If you do, the tyres will be underinflated.

The recommended “cold” tyre pressures are:

kPa (kgf/cm <sup>2</sup> , psi)		
Driver only	Front	250 (2.50 , 36)
	Rear	290 (2.90 , 42)
Driver and one passenger	Front	250 (2.50 , 36)
	Rear	290 (2.90 , 42)

## Inspection

Whenever you check the tyre pressures, you should also examine the tyre treads and sidewalls for wear, damage, and foreign objects:

Look for:

- Bumps or bulges in the side of the tyre or the tread. Replace the tyre if you find any bumps or bulges.
- Cuts, splits or cracks in the tyre. Replace the tyre if you can see fabric or cord.
- Excessive tread wear.

Also, if you hit a pothole or hard object, pull to the side of the road as soon as you safely can and carefully inspect the tyres for damage.

## Tread Wear

Replace tyres before tread depth at the center of the tyre reaches the following limit:

Minimum tread depth	
Front:	1.5 mm (0.06 in)
Rear:	2.0 mm (0.08 in)

< For Germany >

German law prohibits use of tyres whose tread depth is less than 1.6 mm.

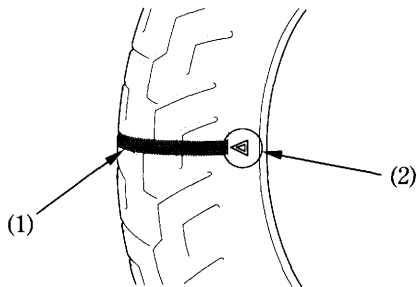

- (1) Wear indicator
- (2) Wear indicator location mark

## **Tyre Repair**

If a tyre is punctured or damaged, you should replace it, not repair it. As discussed below, a tyre that is repaired, either temporarily or permanently, will have lower speed and performance limits than a new tyre.

A temporary repair, such as an external tubeless tyre plug, may not be safe for normal speeds and riding conditions. If a temporary or emergency repair is made to a tyre, you should ride slowly and cautiously to a dealer and have the tyre replaced. If possible, you should not carry a passenger or cargo until a new tyre is installed.

Even if a tyre is professionally repaired with a permanent internal patch plug, it will not be as good as a new tyre. You should not exceed 80 km/h (50 mph) for the first 24 hours, or 130 km/h (80 mph) at any time thereafter. In addition, you may not be able to safely carry as much weight as with a new tyre. Therefore, we strongly recommend that you replace a damaged tyre. If you choose to have a tyre repaired, be sure the wheel is balanced before you ride.

## **Tyre Replacement**

The tyres that came on your motorcycle were designed to match the performance capabilities of your motorcycle and provide the best combination of handling, braking, durability and comfort.

### **⚠ WARNING**

Installing improper tyres on your motorcycle can affect handling and stability. This can cause a crash in which you can be seriously hurt or killed.

Always use the size and type of tyres recommended in this owner's manual.

The recommended tyres for your motorcycle are:

Front: 120/70ZR17M/C (58W)  
MICHELIN  
MACADAM 100X D  
DUNLOP  
D220FST K

Rear: 180/55ZR17M/C (73W)  
MICHELIN  
MACADAM 100X C  
DUNLOP  
D220ST K

Whenever you replace a tyre, use one that is equivalent to the original and be sure the wheel is balanced after the new tyre is installed.

### **Important Safety Reminders**

- Do not install a tube inside a tubeless tyre on this motorcycle. Excessive heat build-up can cause the tube to burst.
- Use only tubeless tyres on this motorcycle. The rims are designed for tubeless tyres, and during hard acceleration or braking, a tube-type tyre could slip on the rim and cause the tyre to rapidly deflate.



# ESSENTIAL INDIVIDUAL COMPONENTS

## IGNITION SWITCH

The ignition switch (1) is below the indicator panel.

The headlight and taillights will come on whenever you turn the ignition switch ON. If your motorcycle is stopped with the ignition switch ON and the engine is not running, the headlight and taillights will still be on, resulting in battery discharge.

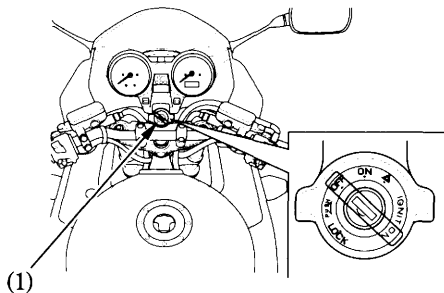

(1) Ignition switch

Key Position	Function	Key Removal
LOCK (steering lock)	Steering is locked. Engine and lights cannot be operated.	Key can be removed
OFF	Engine and lights cannot be operated.	Key can be removed
ON	Engine and lights can be operated.	Key cannot be removed
 (hazard)	When the hazard switch is ON, both left and right turn signals flash. Engine and lights cannot be operated.	Key cannot be removed

## KEYS

This motorcycle has two keys and a key number plate.

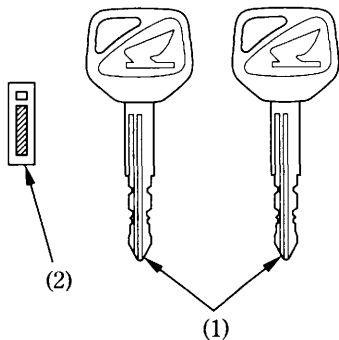

(1) Keys

(2) Key number plate

You will need the key number if you ever have to replace a key. Store the plate in a safe place.

To reproduce keys, bring all keys, key number plate and motorcycle to your Honda dealer.

Up to four keys can be registered with the immobilizer system (HISS), including the ones in hand.

If all keys are lost, the PGM-FI unit/ignition control module must be replaced. To avoid this possibility we recommend that if only one key is left, you immediately have it reproduced to ensure that a back-up is available.

These keys contain electronic circuits that are activated by the immobilizer system (HISS). They will not work to start the engine if the circuits are damaged.

- Do not drop the keys or set heavy objects on them.
- Do not grind, drill or in any way alter the original shape of the keys.
- Keep the keys away from magnetic objects.

## **IMMOBILIZER SYSTEM (HISS)**

HISS is the abbreviation of Honda Ignition Security System.

The immobilizer system (HISS) protects your motorcycle from theft. A properly-coded key must be used in the ignition switch for the engine to start. If an improperly-coded key (or other device) is used the engine's starting circuit is disabled.

When the ignition switch is turned ON and the engine stop switch is at “” (RUN), the immobilizer system (HISS) indicator lights for a few seconds, then goes off. If the indicator remains on, it means the system does not recognize the coding of the key. Turn the ignition switch to OFF, remove the key, reinsert and turn the switch ON again.

The immobilizer system has such a function that keeps the immobilizer system (HISS) indicator blinking at 2 second intervals for 24 hours. This blinking function can be turned on or off.

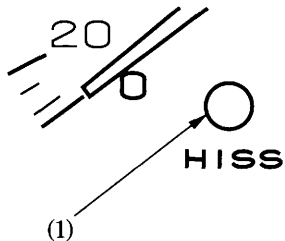

(1) Immobilizer system (HISS) indicator

To alter the blinking function:

1. Turn the ignition switch ON.
2. Press and hold the left control button (2) for more than 2 seconds when the display function mode is odometer.
3. The immobilizer system (HISS) indicator will begin flashing.
4. Turn the ignition switch OFF.

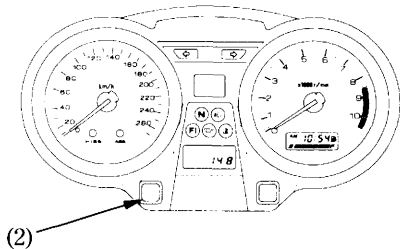

(2) Left control button

If the system repeatedly does not recognize the coding of your key, contact your Honda dealer.

- The system may not recognize the key's coding if any other immobilizer key is near the ignition switch. To make sure the system recognizes the key code, keep each immobilizer key on a separate ring.
- Do not attempt to alter the immobilizer system (HISS) or add other devices to it. Electrical problems could result, making it impossible to start your motorcycle.
- If all keys are lost, the PGM-FI unit/ignition control module must be replaced.

#### EC Directives

This immobilizer system complies with the R & TTE (Radio equipment and telecommunications terminal equipment and the mutual recognition of their conformity) Directive.

**CE 0891 !**

The declaration of conformity to R & TTE Directive is provided to the owner at the time of purchase. The declaration of conformity should be kept at a safe place. When the declaration of conformity is lost or is not provided, contact your Honda dealer.

## RIGHT HANDLEBAR CONTROLS

### Engine Stop Switch

The engine stop switch (1) is next to the throttle grip. When the switch is in the

○ (RUN) position, the engine will operate. When the switch is in the ⊗ (OFF) position, the engine will not operate. This switch is intended primarily as a safety or emergency switch and should normally remain in the ○ (RUN) position.

If your motorcycle is stopped with the ignition switch ON and the engine stop switch ⊗ (OFF), the headlight and taillights will still be on, resulting in battery discharge.

### Starter Button

The starter button (2) is below the engine stop switch (1).

The starter button is used for starting the engine. Pushing the button in starts the engine. See Starting Procedure, page 96 .

When the starter button is pushed, the starter motor will crank the engine, the headlight will automatically go out, but the taillights will stay on.

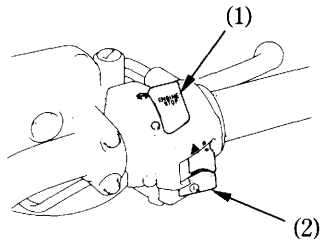

- (1) Engine stop switch
- (2) Starter button

## Hazard Switch

When the hazard switch (1) is  $\triangle$  (ON) position, both left and right turn signals start flashing.

With the ignition switch is  $\triangle$  position, the signals continue flashing even the engine or other lights are OFF.

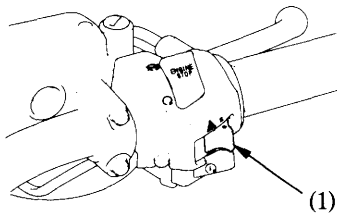



(1) Hazard switch



## LEFT HANDLEBAR CONTROLS



### Headlight Dimmer Switch (1)

Push the dimmer switch to  (HI) to select high beam or to  (LO) to select low beam.

### Passing Light Control Switch (2)

When this switch is pressed, the headlight flashes on to signal approaching cars or when passing.

### Turn Signal Switch (3)

Move to  (L) to signal a left turn,  (R) to signal a right turn. Press to turn signal off.

### Horn Button (4)

Press the button to sound the horn.

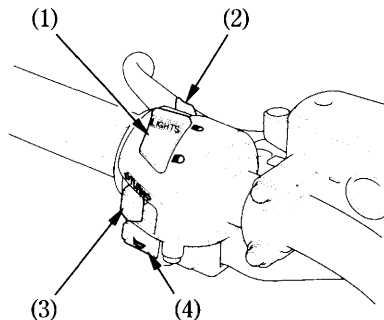

- (1) Headlight dimmer switch
- (2) Passing light control switch
- (3) Turn signal switch
- (4) Horn button

## FEATURES

### (Not required for operation)

#### STEERING LOCK

To lock the steering, turn the handlebar all the way to the left, turn the ignition key (1) to LOCK while pushing in. Remove the key. To unlock the steering, turn the key to OFF while pushing in.

Do not turn the key to LOCK while riding the motorcycle; loss of vehicle control will result.

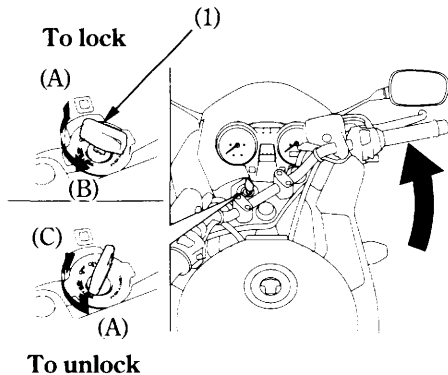

(1) Ignition key

(A) Push in

(B) Turn to LOCK

(C) Turn to OFF

## SEAT

### Front seat

To remove the seat (1), insert the ignition key into the seat lock (2) and turn it clockwise. Pull the seat lock lever (3) downward to unlock the seat. Pull the seat back and up.

To install the seat, insert the front prongs (4) into the front stay (5) and the rear prongs (6) into the rear stays (7) on the frame.

Push forward and then down on the rear of the seat.

Be sure the seat is locked securely in position after installation.

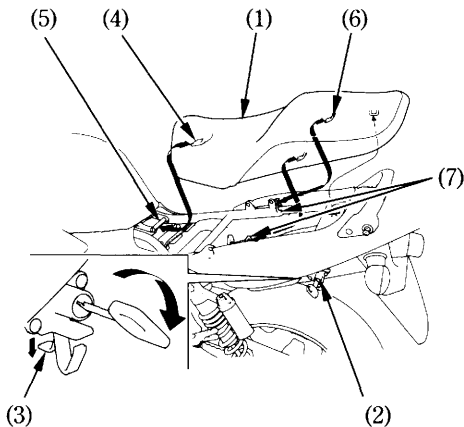

- |                 |                 |
|-----------------|-----------------|
| (1) Seat        | (5) Front stay  |
| (2) Seat lock   | (6) Rear prongs |
| (3) Lock lever  | (7) Rear stays  |
| (4) Front prong |                 |

## HELMET HOLDER

The helmet holder (1) is on the left side below the seat.

Insert the ignition key (2) and turn it clockwise to unlock. Hang your helmet on the holder hook (3). Turn the key counterclockwise to lock the holder hook and then remove the key.

### **⚠ WARNING**

Riding with a helmet attached to the holder can interfere with the rear wheel or suspension and could cause a crash in which you can be seriously hurt or killed.

Use the helmet holder only while parked. Do not ride with a helmet secured by the holder.

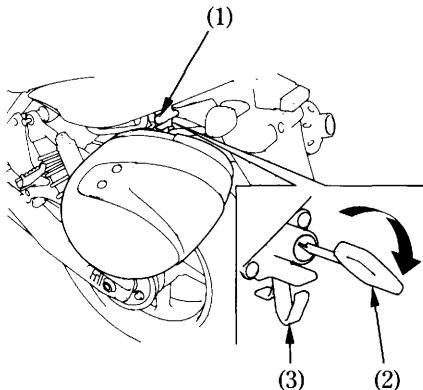

- (1) Helmet holder
- (2) Ignition key
- (3) Holder hook

## **DOCUMENT BAG**

The document bag (1) is in the document compartment (2) under the seat.

This owner's manual and other documents should be stored in the document bag.

When washing your motorcycle, be careful not to flood this area with water.

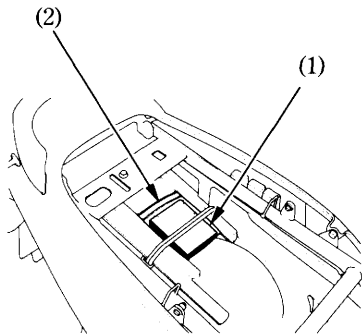

- (1) Document bag
- (2) Document compartment

## CENTER COMPARTMENT

The centre compartment (1) is below the seat.

This compartment is for light weight items. Cargo in the storage compartment should not exceed:

3.0 kg (6.6 lbs)

Never exceed the maximum weight limit; handling and stability may be severely affected.

The center compartment may become heated by the engine. Do not store food and other articles which are flammable or susceptible to heat damage in this compartment.

Do not direct water under pressure against the center compartment as water will be forced into the compartment.

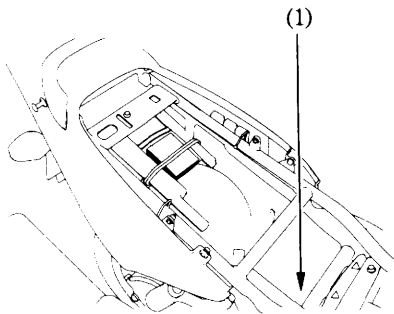

(1) Center compartment

## STORAGE COMPARTMENT FOR U-SHAPED ANTI-THEFT LOCK

The rear fender has a storage compartment to store a U-shaped anti-theft lock under the seat. After storing, be sure to fasten the lock with the rubber band (1) securely.

Some U-shaped locks may not be stored in the compartment due to their size or design.

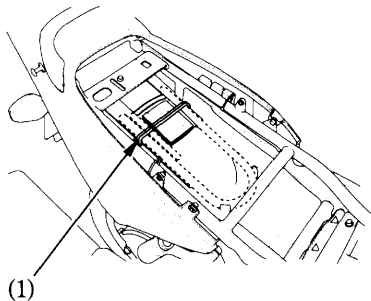

(1) Rubber band

## **RIGHT POCKET CB1300S/SA**

There is right pocket (1) below the right side of the handlebar.

The maximum allowable load in the right pocket shall be no more than:

0.5 kg (1.1 lbs)

Do not open the right pocket while riding the motorcycle.

To open the right pocket (1) pull the right pocket cover (2).

Make sure the right pocket cover is closed before riding.

When washing your motorcycle be careful not to flood this area with water.

Do not store valuables or fragile articles in the right pocket.

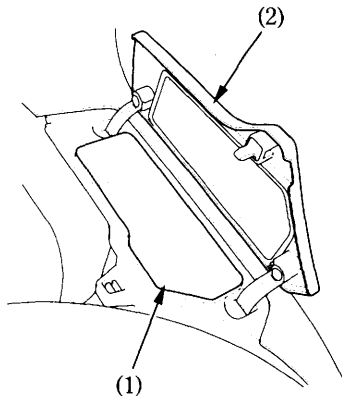

- (1) Right pocket
- (2) Right pocket cover



## **LEFT POCKET CB1300S/SA**

There is left pocket (1) below the left side of the handlebar.

The maximum allowable load in the left pocket shall be no more than:

0.5 kg (1.1 lbs)

Do not open the left pocket while riding the motorcycle.

To open the left pocket (1), insert the ignition key (2), turn it clockwise.

Make sure the left pocket cover (3) is closed before riding.

When washing your motorcycle be careful not to flood this area with water.

Do not store valuables or fragile articles in the left pocket.

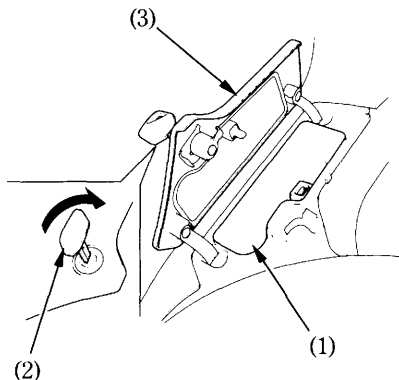

- (1) Left pocket
- (2) Ignition key
- (3) Left pocket cover

## SIDE COVER

The right side cover must be removed for the air cleaner maintenance. The left side cover must be removed for fuse maintenance.

The right and left side covers can be removed in the same manner.

### Removal:

1. Remove the seat (page 79).
2. Remove the bolts (1).
3. Remove the prongs (2) from the grommets (3).

### Installation:

- Installation can be done in the reverse order of removal.

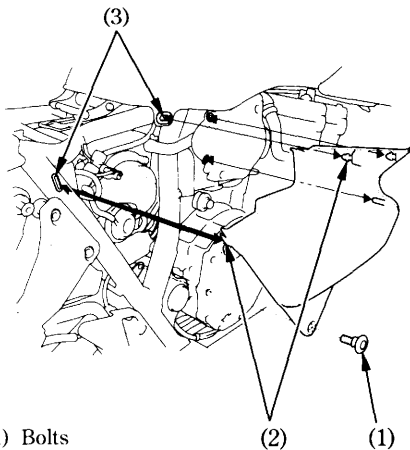

- (1) Bolts
- (2) Prongs
- (3) Grommets

## LOWER COWL CB1300S/SA

### Removal:

1. Remove the clips A (1).
2. Remove the bolts (2).
3. Remove the lower cowl ( 3 ).

### Installation:

- Installation can be done in the reverse order of removal.

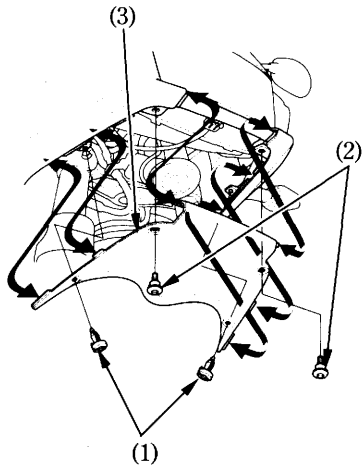

- (1) Clips A
- (2) Bolts
- (3) Lower cowl

## LEFT SIDE COWL CB1300S/SA

### Removal:

1. Remove the lower cowl (page 87 ).
2. Remove the clips A (1).
3. Remove the screw (2).
4. Remove the meter cover (3).
5. Use the 6 mm hex wrench (4) and extension bar (5) to remove the bolts (6).
6. Remove the clip A (7).
7. Remove the left side cowl (8) and disconnect the front turn signal connector (9).

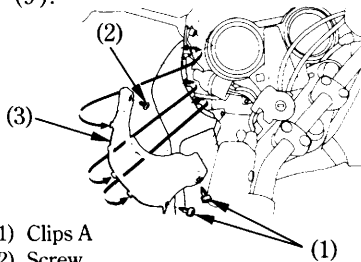

- (1) Clips A
- (2) Screw
- (3) Meter cover

### Installation:

- Installation can be done in the reverse order of removal.

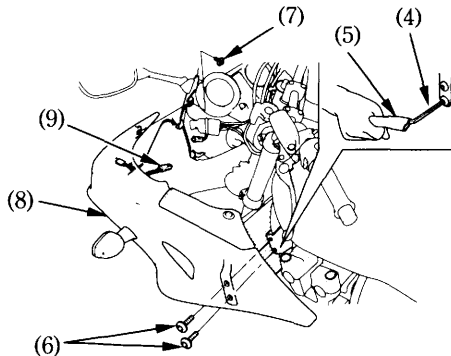

- (4) 6mm hex wrench
- (5) Extension bar
- (6) Bolts
- (7) Clip A
- (8) Left side cowl
- (9) Front turn signal connector

## Clip A removal and installation:

### **Removal**

- ① Press down on the center pin to release the lock.
- ② Pull out the clip from the hole.

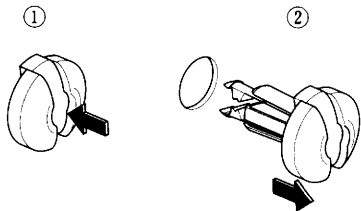

### **Installation**

- ① Slightly open the retaining pawls and then push them out.
- ② Insert the clip into the hole.
- ③ Lightly press down on the center pin to lock the clip.

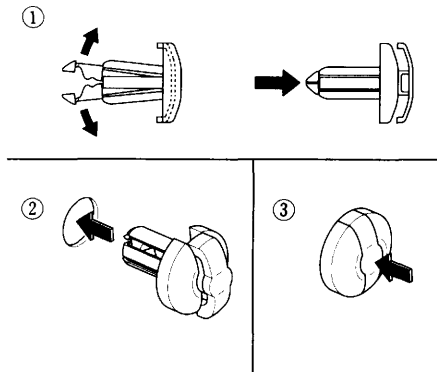

## FUEL TANK MAINTENANCE POSITION

The front of the fuel tank can be tilted up for maintenance.

The fuel tank does not require draining.

To raise:

1. Place the motorcycle on its side stand with the transmission in neutral and the ignition switch off.
2. Make the handlebar straight.
3. Remove the side cover (page 86 ).
4. Remove the bolts (1).
5. Pull up the rear end of the fuel tank and release the tank from the cushion rubbers (2) on the frame.

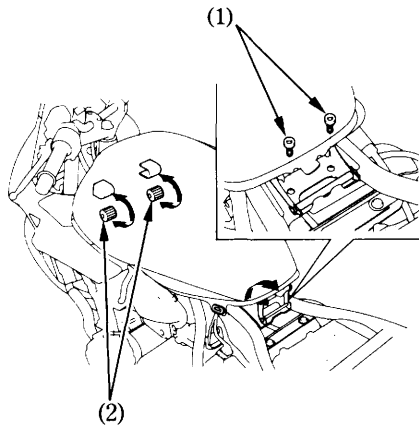

- (1) Bolts  
(2) Cushion rubbers

6. Topple the rear bracket (3).
7. Make a suitable prop by inserting a Standard/Phillips screwdriver (4) from the tool kit in the screwdriver handle (5).
8. Raise the front of the fuel tank (6) and place the Standard/Phillips screwdriver and screwdriver handle between the front of the fuel tank and frame body.

Do not raise the fuel tank higher than the wire allows.

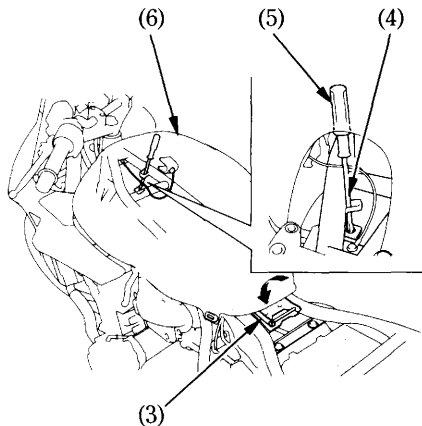

- (3) Rear bracket
- (4) Standard/Phillips screwdriver
- (5) Screwdriver handle
- (6) Fuel tank

## HEADLIGHT AIM VERTICAL ADJUSTMENT

### CB1300S/SA

Vertical adjustment can be made by turning the knob (1) in or out as necessary.  
Obey local laws and regulations.

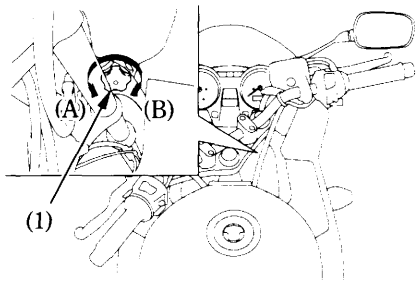

(1) Knob

(A) Up

(B) Down

### CB1300/A

Vertical adjustment can be made by moving the headlight case (1) as necessary.  
To move the headlight case (1), loosen the bolts (2).  
Tighten the bolts (2) after adjustment.  
Obey local laws and regulations.

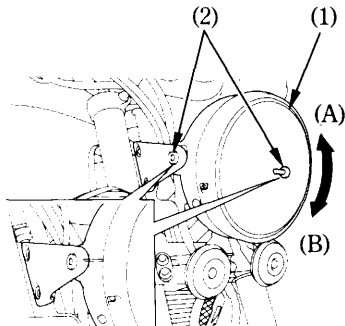

(1) Headlight case

(A) Up

(2) Bolts

(B) Down



## OPERATION

### PRE-RIDE INSPECTION

For your safety, it is very important to take a few moments before each ride to walk around your motorcycle and check its condition. If you detect any problem, be sure you take care of it, or have it corrected by your Honda dealer.

### WARNING

Improperly maintaining this motorcycle or failing to correct a problem before riding can cause a crash in which you can be seriously hurt or killed.

Always perform a pre-ride inspection before every ride and correct any problems.

1. Engine oil level—add engine oil if required (page 62 ). Check for leaks.
2. Fuel level—fill fuel tank when necessary (page 59 ). Check for leaks.
3. Coolant level—add coolant if required. Check for leaks (pages 57 – 58 ).
4. Front and rear brakes—check operation; make sure there is no brake fluid leakage (pages 52 – 54 ).

5. Tyres—check condition and pressure (pages 63 – 68 ).
6. Drive chain—check condition and slack (page 132 ). Adjust and lubricate if necessary.
7. Throttle—check for smooth opening and full closing in all steering positions.
8. Lights and horn—check that headlight, stop/tail light, turn signals, indicators and horn function properly.
9. Engine stop switch—check for proper function (page 75 ).
10. Side stand ignition cut-off system—check for proper function (page 140 ).

## **STARTING THE ENGINE**

Always follow the proper starting procedure described below.

This motorcycle is equipped with a side stand ignition cut-off system. The engine cannot be started if the side stand is down, unless the transmission is in neutral. If the side stand is up, the engine can be started in neutral or in gear with the clutch lever pulled in. After starting with the side stand down, the engine will shut off if the transmission is put in gear before raising the side stand.

To protect the catalytic converters in your motorcycle's exhaust system, avoid extending idling and the use of leaded petrol.

Your motorcycle's exhaust contains poisonous carbon monoxide gas. High levels of carbon monoxide can collect rapidly in enclosed areas such as a garage. Do not run the engine with the garage door closed. Even with the door open, run the engine only long enough to move your motorcycle out of the garage.

Do not use the electric starter for more than 5 seconds at a time. Release the starter button for approximately 10 seconds before pressing it again.

## Preparation

Before starting, insert the key, turn the ignition switch ON and confirm the following:

- The transmission is in NEUTRAL (neutral indicator light ON).
- The engine stop switch is at  $\bigcirc$  (RUN).
- The red low oil pressure indicator is ON.
- The PGM-FI indicator is OFF.
- The immobilizer system (HISS) indicator is OFF.

The low oil pressure indicator should go off a few seconds after the engine starts. If the low oil pressure indicator lights during operation, stop the engine immediately and check the engine oil level.

### NOTICE

Operating the engine with insufficient oil pressure can cause serious engine damage.

## Starting Procedure

To restart a warm engine, follow the procedure for "High Air Temperature."

### Normal Air Temperature

$10^{\circ} - 35^{\circ}\text{C}$  ( $50^{\circ} - 95^{\circ}\text{F}$ )

1. Pull the choke knob (1) out all the way to Fully ON (A).
2. With the throttle completely closed, press the starter button.

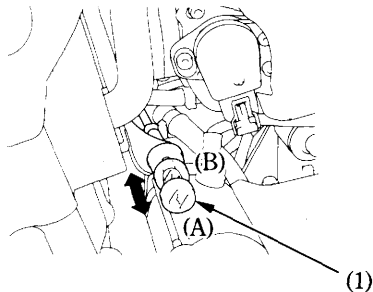

(1) Choke knob

(A) Fully ON

(B) Fully OFF

Do not open the throttle when starting the engine with the choke ON. This will lean the mixture, resulting in hard starting.

#### **NOTICE**

Operating the engine with insufficient oil pressure can cause serious engine damage.

3. About a half minute after the engine starts, push the choke knob (1) in all the way to Fully OFF (B).
4. If idling is unstable, open the throttle slightly.

The engine will not start if the throttle is fully open (because the electronic control module cuts off the fuel supply).

#### High Air Temperature 35°C (95°F) or above

1. Do not use the choke.
2. Start the engine.

The radiator cooling fan may start to rotate when the choke knob is pulled out with the engine heated, but this is normal. As this takes place, check that the choke knob is returned completely.

## Low Air Temperature

10°C (50°F) or below

1. Follow steps 1 – 2 under “Normal Air Temperature.”
2. When engine speed begins to pick up, operate the choke knob to keep fast idle at:  
1,500 – 2,000 min<sup>-1</sup> (rpm)
3. Continue warming up the engine until it runs smoothly and responds to the throttle, when the choke knob (1) is at Fully OFF (B).

### **NOTICE**

Extended use of the choke may impair piston and cylinder wall lubrication and damage the engine.

## **Flooded Engine**

If the engine fails to start after repeated attempts, it may be flooded.

1. Leave the engine stop switch set to  (RUN).
2. Open throttle fully.
3. Press the starter button for 5 seconds.
4. Follow the normal starting procedure.
5. If the engine starts with unstable idle, open the throttle slightly.  
If the engine does not start, wait for 10 seconds, then follow steps 1 – 4 again.

## **Ignition Cut Off**

Your motorcycle is designed to automatically stop the engine and fuel pump if the motorcycle is over-turned (a banking sensor cuts off the ignition system). Before restarting the engine, you must turn the ignition switch to the OFF position and then back to ON.

## **RUNNING-IN**

Help assure your motorcycle's future reliability and performance by paying extra attention to how you ride during the first 500 km (300 miles).

During this period, avoid full-throttle starts and rapid acceleration.



## **RIDING**

Review Motorcycle Safety (pages 1 – 7 ) before you ride.

Make sure you understand the function of the side stand mechanism. (See MAINTENANCE SCHEDULE on page 111 and explanation for SIDE STAND on page 140).

Make sure flammable materials such as dry grass or leaves do not come in contact with the exhaust system when riding, idling, or parking your motorcycle.

1. After the engine has been warmed up, the motorcycle is ready for riding.
2. While the engine is idling, pull in the clutch lever and depress the gearshift pedal to shift into 1st (low) gear.
3. Slowly release the clutch lever and at the same time gradually increase engine speed by opening the throttle. Coordination of the throttle and clutch lever will assure a smooth positive start.

4. When the motorcycle attains a moderate speed, close the throttle, pull in the clutch lever and shift to 2nd gear by raising the gearshift pedal.

This sequence is repeated to progressively shift to 3rd, 4th and 5th (top) gears.

5. Coordinate the throttle and brakes for smooth deceleration.
6. Both front and rear brakes should be used at the same time and should not be applied strongly enough to lock the wheel, or braking effectiveness will be reduced and control of the motorcycle be difficult.

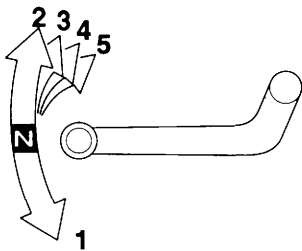

## **BRAKING**

For normal braking, apply both the brake pedal and lever while down-shifting to match your road speed. For maximum braking, close the throttle and firmly apply the pedal and lever; pull in the clutch lever before coming to a complete stop to prevent stalling the engine.

### **Important Safety Reminders:**

- Independent operation of only the brake lever or brake pedal reduces stopping performance.
- Extreme application of the brake controls may cause wheel lock, reducing control of the motorcycle.
- When possible, reduce speed or brake before entering a turn; closing the throttle or braking in mid-turn may cause wheel slip. Wheel slip will reduce control of the motorcycle.

- When riding in wet or rainy conditions, or on loose surfaces, the ability to maneuver and stop will be reduced. All of your actions should be smooth under these conditions. Rapid acceleration, braking or turning may cause loss of control. For your safety, exercise extreme caution when braking, accelerating or turning.
- When descending a long, steep grade, use engine compression braking by down-shifting, with intermittent use of both brakes.  
Continuous brake application can overheat the brakes and reduce their effectiveness.
- Riding with your foot resting on the brake pedal or your hand on the brake lever may actuate the stoplight, giving a false indication to other drivers. It may also overheat the brakes, reducing effectiveness.

## **Anti-lock Brake System (ABS)**

### **CB1300A/SA**

This model is also equipped with an Anti-lock Brake System (ABS) designed to help prevent wheel lock up during hard braking on uneven or other poor surfaces while running straight. Although the wheel may not lock up – if you are braking too hard in a turn the motorcycle can still lose traction, causing a loss of control.

In some situations, a motorcycle with ABS may require a longer stopping distance to stop on loose or uneven surfaces than an equivalent motorcycle without ABS.

ABS cannot make up for road conditions, bad judgment, or improper operation of the brakes. It is still your responsibility to ride at reasonable speeds for weather, road surface, and traffic conditions, and to leave a margin of safety.

ABS is self-checking and always on.

- ABS may be activated by riding over a sharp drop or rise in the road level. It is important to follow the tyre recommendations (page 63 ). The ABS computer works by comparing wheel speed. Non-recommended tyres can affect wheel speed and may confuse the ABS computer.
- ABS does not function at low speeds (approximately 10 km/h (6 mph) or below).
- ABS does not function if the battery is discharged.

## **ABS Indicator Light CB1300A/SA**

Normally, this light comes on when the ignition is turned ON, and goes off after you ride the motorcycle at speed above 10 km/h (6 mph). If there is an ABS problem, the indicator light flashes and remains on. The ABS system does not operate when the ABS indicator light is on.

If the ABS indicator light comes on while riding, stop the motorcycle in a safe place and turn off the engine.

Turn the ignition ON again. The light should come on, and go off after you ride the motorcycle at speeds above 10 km/h (6 mph). If it does not go off, ABS is not functioning, but the brakes still work provide normal stopping ability. However, you should have the system checked by Honda dealer as soon as possible.

The ABS indicator light may flashes if you turn the rear wheel at high speed for more than 30 seconds while the motorcycle is upright on the stand. This is normal. Turn the ignition OFF, then turn it ON. The indicator should come on, then go off after you run the motorcycle above 10 km/h (6 mph).

## **PARKING**

1. After stopping the motorcycle, shift the transmission into neutral, turn the handlebar fully to the left, turn the ignition switch OFF and remove the key.
2. Use the side stand to support the motorcycle while parked.

Park the motorcycle on firm, level ground to prevent it from falling over.

If you must park on a slight incline, aim the front of the motorcycle uphill to reduce the possibility of rolling off the side stand or overturning.

3. Lock the steering to help prevent theft (page 78 ).

Make sure flammable materials such as dry grass or leaves do not come in contact with the exhaust system when parking your motorcycle.

## **ANTI-THEFT TIPS**

1. Always lock the steering and never leave the key in the ignition switch. This sounds simple but people do forget.
2. Be sure the registration information for your motorcycle is accurate and current.
3. Park your motorcycle in a locked garage whenever possible.
4. Use an additional anti-theft device of good quality.
5. Put your name, address, and phone number in this Owner's Manual and keep it on your motorcycles at all times.

Many times stolen motorcycles are identified by information in the Owner's Manuals that are still with them.

NAME: \_\_\_\_\_

ADDRESS: \_\_\_\_\_

\_\_\_\_\_

\_\_\_\_\_

PHONE NO: \_\_\_\_\_

## MAINTENANCE

### THE IMPORTANCE OF MAINTENANCE

A well-maintained motorcycle is essential for safe, economical and trouble-free riding. It will also help reduce air pollution.

To help you properly care for your motorcycle, the following pages include a Maintenance Schedule and a Maintenance Record for regularly scheduled maintenance.

These instructions are based on the assumption that the motorcycle will be used exclusively for its designed purpose. Sustained high speed operation or operation in unusually wet or dusty conditions will require more frequent service than specified in the Maintenance Schedule. Consult your Honda dealer for recommendations applicable to your individual needs and use.

If your motorcycle overturns or becomes involved in a crash, be sure your Honda dealer inspects all major parts, even if you are able to make some repairs.

### **WARNING**

Improperly maintaining this motorcycle or failing to correct a problem before you ride can cause a crash in which you can be seriously hurt or killed.

Always follow the inspection and maintenance recommendations and schedules in this owner's manual.



## **MAINTENANCE SAFETY**

This section includes instructions on some important maintenance tasks. You can perform some of these tasks with the tools provided – if you have basic mechanical skills.

Other tasks that are more difficult and require special tools are best performed by professionals. Wheel removal should normally be handled only by a Honda technician or other qualified mechanic; instructions are included in this manual only to assist in emergency service.

Some of the most important safety precautions follow. However, we cannot warn you of every conceivable hazard that can arise in performing maintenance. Only you can decide whether or not you should perform a given task.

## **WARNING**

Failure to properly follow maintenance instructions and precautions can cause you to be seriously hurt or killed.

Always follow the procedures and precautions in this owner's manual.

## SAFETY PRECAUTIONS

- Make sure the engine is off before you begin any maintenance or repairs. This will help eliminate several potential hazards:
  - \* **Carbon monoxide poisoning from engine exhaust.**  
Be sure there is adequate ventilation whenever you operate the engine.
  - \* **Burns from hot parts.**  
Let the engine and exhaust system cool before touching.
  - \* **Injury from moving parts.**  
Do not run the engine unless instructed to do so.
- Read the instructions before you begin, and make sure you have the tools and skills required.
- To help prevent the motorcycle from falling over, park it on a firm, level surface, using the center stand or a maintenance stand to provide support.

- To reduce the possibility of a fire or explosion, be careful when working around petrol or batteries. Use only nonflammable solvent, not petrol, to clean parts. Keep cigarettes, sparks and flames away from the battery and all fuel-related parts.

Remember that your Honda dealer knows your motorcycle best and is fully equipped to maintain and repair it.

To ensure the best quality and reliability, use only new genuine Honda parts or their equivalents for repair and replacement.

## **MAINTENANCE SCHEDULE**

Perform the Pre-ride Inspection (page 93 ) at each scheduled maintenance period.

**I: INSPECT AND CLEAN, ADJUST, LUBRICATE OR REPLACE IF NECESSARY**

**C: CLEAN R: REPLACE A: ADJUST L: LUBRICATE**

The following Maintenance Schedule specifies all maintenance required to keep your motorcycle in peak operating condition. Maintenance work should be performed in accordance with standards and specifications of Honda by properly trained and equipped technicians. Your Honda dealer meets all of these requirements.

- \* Should be serviced by your Honda dealer, unless the owner has proper tools and service data and is mechanically qualified. Refer to the Official Honda Shop Manual.
- \*\* In the interest of safety, we recommend these items be serviced only by your Honda dealer.

Honda recommends that your Honda dealer should road test your motorcycle after each periodic maintenance is carried out.

- NOTES: (1) At higher odometer readings, repeat at the frequency interval established here.
- (2) Service more frequently if the motorcycle is ridden in unusually wet or dusty areas.
- (3) Service more frequently when riding in rain or at full throttle.
- (4) Replace every 2 years, or at indicated odometer interval, whichever comes first. Replacement requires mechanical skill.

ITEM	FREQUENCY	WHICHEVER → COMES FIRST *	ODOMETER READING [NOTE (1)]								Refer to Page
			× 1,000 km	1	6	12	18	24	30	36	
			× 1,000 mi	0.6	4	8	12	16	20	24	
	NOTE	MONTH		6	12	18	24	30	36		
* FUEL LINE					I		I		I	—	
* THROTTLE OPERATION					I		I		I	128	
AIR CLEANER	NOTE (2)					C			C	131	
SPARK PLUGS					I		R		I	125	
* CHOKE OPERATION					I		I		I	—	
* VALVE CLEARANCE							I			—	
ENGINE OIL			R		R		R		R	117	
ENGINE OIL FILTER			R		R		R		R	120	
* ENGINE IDLE SPEED			I		I		I		I	129	
CRANKCASE BREATHER	NOTE (3)			I	I	I	I	I	I	123	
RADIATOR COOLANT	NOTE (4)				I		I		R	57	
* COOLING SYSTEM					I		I		I	—	
* SECONDARY AIR SUPPLY SYSTEM					I		I		I	—	

ITEM	FREQUENCY	WHICHEVER → COMES FIRST ↓ NOTE	ODOMETER READING [ NOTE (1) ]								Refer to Page	
			× 1,000 km	1	6	12	18	24	30	36		
			× 1,000 mi	0.6	4	8	12	16	20	24		
		NOTE	MONTH		6	12	18	24	30	36		
DRIVE CHAIN				I, L EVERY 1,000 km (600 mi)								132
DRIVE CHAIN SLIDER						I		I		I	138	
BRAKE FLUID		NOTE (4)			I	I	R	I	I	R	52	
BRAKE PAD WEAR					I	I	I	I	I	I	147	
BRAKE SYSTEM				I		I		I		I	52	
* BRAKE LIGHT SWITCH						I		I		I	—	
* HEADLIGHT AIM						I		I		I	—	
CLUTCH SYSTEM						I		I		I	55	
CLUTCH FLUID		NOTE (4)			I	I	R	I	I	R	55	
SIDE STAND						I		I		I	140	
* SUSPENSION						I		I		I	139	
* NUTS, BOLTS, FASTENERS				I		I		I		I	—	
** WHEELS/TYRES						I		I		I	—	
** STEERING HEAD BEARINGS				I		I		I		I	—	

## TOOL KIT

The tool kit (1) is stored on the under side of the seat.

Some roadside repairs, minor adjustments and parts replacement can be performed with the tools contained in the kit.

- Spark plug wrench
- 10 × 12 mm Open end wrench
- 14 × 17 mm Open end wrench
- 8 mm Open end wrench
- 27 mm Box end wrench
- 32 mm Box end wrench
- Screwdriver handle
- Pliers
- Extension bar
- Pin spanner
- 5 mm Hex wrench
- 6 mm Hex wrench
- Standard/Phillips screwdriver
- Tool bag

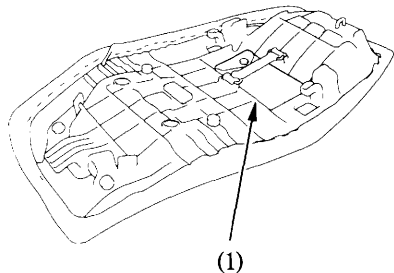

(1) Tool kit

## SERIAL NUMBERS

The frame and engine serial numbers are required when registering your motorcycle. They may also be required by your dealer when ordering replacement parts.

Record the numbers here for your reference.

FRAME NO. \_\_\_\_\_

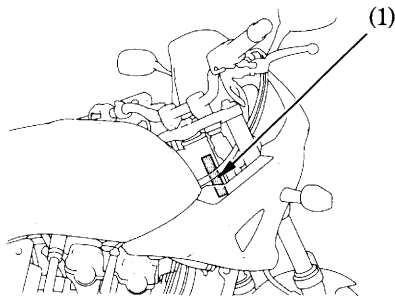

(1) Frame number

The frame number (1) is stamped on the right side of the steering head.

The engine number (2) is stamped on top of the crankcase.

ENGINE NO. \_\_\_\_\_

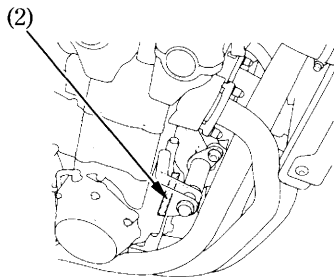

(2) Engine number

## COLOUR LABEL

The colour label (1) is attached to the frame below the seat (page 79 ).

It is helpful when ordering replacement parts. Record the colour and code here for your reference.

COLOUR \_\_\_\_\_

CODE \_\_\_\_\_

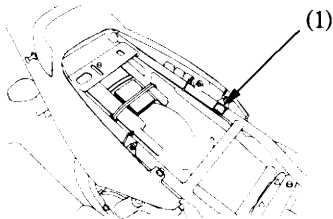

(1) Colour label



## ENGINE OIL

Refer to the Safety Precautions on page 110.

### Oil Recommendation

API classification	SG or higher except oils labeled as energy conserving on the circular API service label
Viscosity	SAE 10W-40
JASO T 903 standard	MA

Suggested Oil
Honda "4-STROKE MOTORCYCLE OIL" or equivalent.

Your motorcycle does not need oil additives. Use the recommended oil.

Do not use oils with graphite or molybdenum additives. They may adversely affect clutch operation.

Do not use API SH or higher oils displaying a circular API "energy conserving" service label on the container. They may affect lubrication and clutch performance.

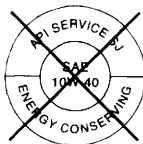

NOT RECOMMENDED

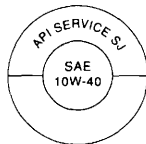

OK

Do not use non-detergent, vegetable, or castor based racing oils.

### Viscosity:

Viscosity grade of engine oil should be based on average atmospheric temperature in your riding area. The following provides a guide to the selection of the proper grade or viscosity of oil to be used at various atmospheric temperatures.

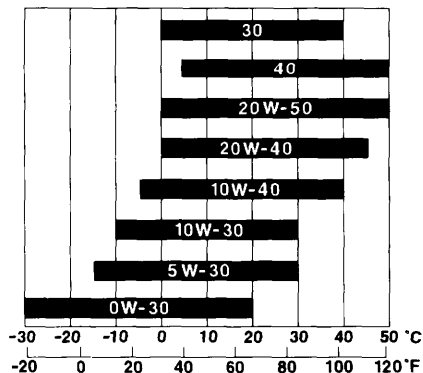

### JASO T 903 standard

The JASO T 903 standard is an index for choosing engine oils for 4-stroke motorcycle engines.

There are two classes: MA and MB.

Oil conforming to the standard is labeled on the oil container. For example, the following label shows the MA classification.

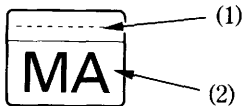

PRODUCT MEETING JASO T 903  
COMPANY GUARANTEEING THIS MA PERFORMANCE:

- (1) Code number of the sales company of the oil
- (2) Oil classification

## **Engine Oil and Filter**

Engine oil quality is the chief factor affecting engine service life. Change the engine oil as specified in the maintenance schedule (page 111).

When running in very dusty conditions, oil changes should be performed more frequently than specified in the maintenance schedule.

Please dispose of used engine oil in a manner that is compatible with the environment. We suggest you take it in a sealed container to your local recycling center or service station for reclamation. Do not throw it in the trash or pour it on the ground or down a drain.

Used engine oil may cause skin cancer if repeatedly left in contact with the skin for prolonged periods. Although this is unlikely unless you handle used oil on a daily basis, it is still advisable to thoroughly wash your hands with soap and water as soon as possible after handling used oil.

Changing the oil filter requires a special oil filter tool and a torque wrench. If you do not have these tools and the necessary skill, we recommend that you have your Honda dealer perform this service.

If a torque wrench is not used for this installation, see your Honda dealer as soon as possible to verify proper assembly.

Change the engine oil with the engine at normal operating temperature and the motorcycle on its side stand to assure complete and rapid draining.

1. To drain the oil, remove the oil filler cap, crankcase drain plug (1) and sealing washer (2).

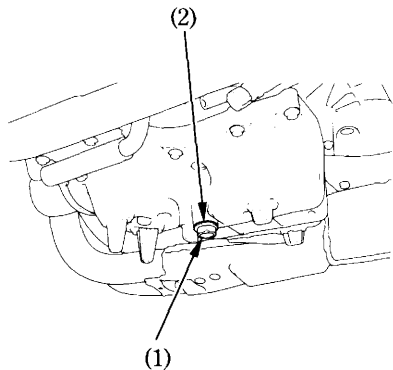

(1) Crankcase drain plug    (2) Sealing washer

2. Remove the oil filter (3) with a filter wrench and let the remaining oil drain out. Discard the oil filter.

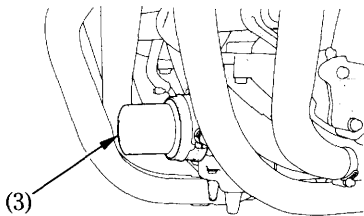

(3) Oil filter

3. Apply a thin coat of engine oil to the new oil filter rubber seal (4).
4. Using a special tool and a torque wrench, install the new oil filter and tighten to a torque of:  
26 N·m (2.7 kgf·m , 20 lbf·ft)

Use only the Honda genuine oil filter or a filter of equivalent quality specified for your model. Using the wrong Honda filter or a non-Honda filter which is not of equivalent quality may cause engine damage.

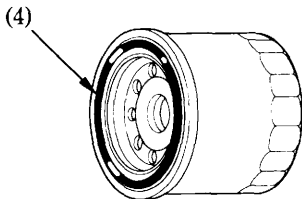

(4) Oil filter rubber seal

5. Check that the sealing washer on the drain plug is in good condition and install the plug. Replace the sealing washer every other time the oil is changed, or each time if necessary.  
Oil drain plug Torque:  
29 N·m (3.0 kgf·m , 22 lbf·ft)
6. Fill the crankcase with the recommended grade oil; approximately:  
3.9 ℓ (4.1 US qt , 3.4 Imp qt)
7. Install the oil filler cap.
8. Start the engine and let it idle for 3–5 minutes.
9. 2–3 minutes after stopping the engine, check that the oil level is at the upper level mark in the inspection window with the motorcycle upright on firm, level ground. Make sure there are no oil leaks.

## CRANKCASE BREATHER

Refer to the Safety Precautions on page 110.

1. Remove the drain tube (1) and drain deposits into a suitable container.
2. Reinstall the drain tube.

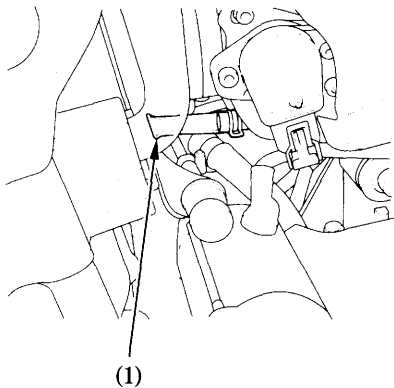

(1) Drain tube

1. Remove the crankcase breather tube plug (1) from the tube and drain deposits into a suitable container.
2. Reinstall the crankcase breather tube plug.

Service more frequently when riding in rain, at full throttle, or after the scooter is washed or overturned. Service if the deposit level can be seen in the transparent section of the drain tube.

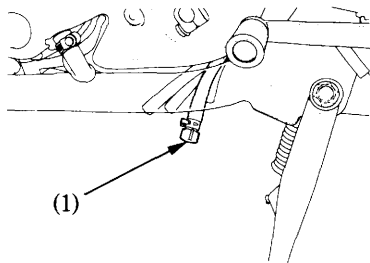

(1) Crankcase breather tube plug



## **SPARK PLUGS**

Refer to the Safety Precautions on page 110.

Recommended plugs:

Standard:

DPR8EA-9 (NGK) or  
X24EPR-U9 (DENSO)

For extended high speed riding:

DPR9EA-9 (NGK) or  
X27EPR-U9 (DENSO)

### **NOTICE**

Never use a spark plug with an improper heat range. Severe engine damage could result.

1. Remove the right and left side covers (page 86 ).
2. Raise the fuel tank (page 90 ).
3. Disconnect the spark plug caps from the spark plugs.
4. Clean any dirt from around the spark plug bases.

Remove the spark plugs using the spark plug wrench ( 1 ) furnished in the tool kit.

5. Inspect the electrodes and center porcelain for deposits, erosion or carbon fouling. If the erosion or deposit is heavy, replace the plug. Clean a carbon or wet-fouled plug with a plug cleaner, otherwise use a wire brush.

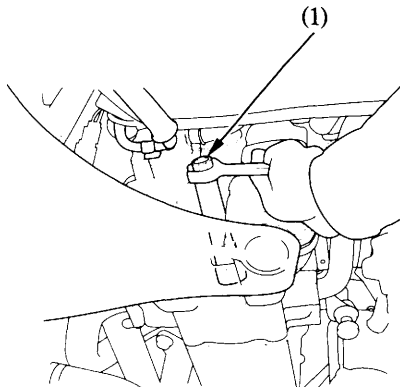

(1) Spark plug wrench

6. Check the spark plug gap ( 2 ) using a wire-type feeler gauge. If adjustment is necessary, bend the side electrode ( 3 ) carefully.

The gap should be:

0.8–0.9 mm (0.03–0.04 in)

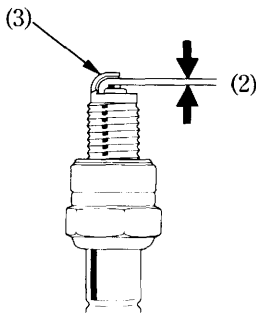

- (2) Spark plug gap  
(3) Side electrode

7. With the plug washer attached, thread the spark plug in by hand to prevent cross-threading.
8. Tighten each spark plug:
- If the old plug is good:  
1/8 turn after it seats.
  - If installing a new plug, tighten it twice to prevent loosening:
    - a) First, tighten the plug:  
NGK: 3/4 turn after it seats.  
DENSO: 1/2 turn after it seats.
    - b) Then loosen the plug.
    - c) Next, tighten the plug again:  
1/8 turn after it seats.

#### NOTICE

Improperly tightened spark plug can damage the engine. If a plug is too loose, a piston may be damaged. If a plug is too tight, the threads may be damaged.

9. Reinstall the spark plug caps.  
10. Install the remaining parts in the reverse order of removal.

## THROTTLE OPERATION

Refer to the Safety Precautions on page 110.

1. Check for smooth rotation of the throttle grip from the fully open to the fully closed position at both full steering positions.
2. Measure the throttle grip freeplay at the throttle grip flange.  
The standard freeplay should be approximately:  
2–4 mm (0.1–0.2 in)

To adjust the freeplay, loosen the lock nut (1) and turn the adjuster (2).

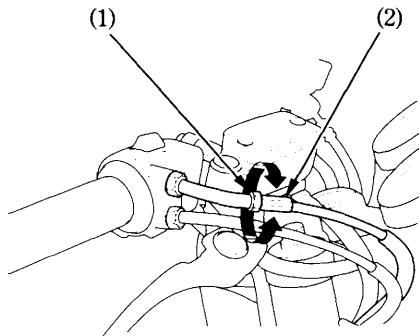

(1) Lock nut

(2) Adjuster

## IDLE SPEED

Refer to the Safety Precautions on page 110.

The engine must be at normal operating temperature for accurate idle speed adjustment. 10 minutes of stop-and-go riding is sufficient.

1. Remove the right and left side covers (page 86).
2. Remove the mounting bolts (1) and cover (2).
3. Warm up the engine, shift to neutral, and place the motorcycle on its side stand.
4. Adjust idle speed with the throttle stop screw (3).

Idle speed (In neutral):

$1,000 \pm 100 \text{ min}^{-1} (\text{rpm})$

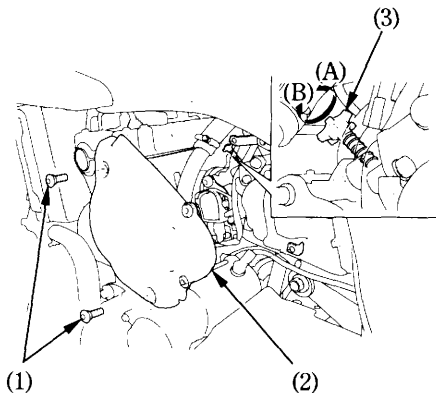

(1) Bolts

(2) Cover

(3) Throttle stop screw

(A) Increase

(B) Decrease

## COOLANT

Refer to the Safety Precautions on page 110.

### Coolant Replacement

Coolant should be replaced by a Honda dealer, unless the owner has proper tools and service data and is mechanically qualified. Refer to an official Honda Shop Manual.

Always add coolant to the reserve tank. Do not attempt to add coolant by removing the radiator cap.

## WARNING

Removing the radiator cap while the engine is hot can cause the coolant to spray out, seriously scalding you.

Always let the engine and radiator cool down before removing the radiator cap.

## AIR CLEANER

Refer to the Safety Precautions on page 110 .

The air cleaner should be serviced at regular intervals (page 112). Service more frequently when riding in unusually wet or dusty areas.

1. Remove the right side cover (page 86 ).
2. Remove the attaching screws (1) and air cleaner housing cover (2).

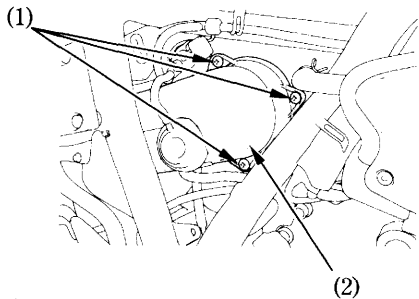

- (1) Attaching screws
- (2) Air cleaner housing cover

3. Pull out the air cleaner (3) and clean the air cleaner using compressed air from the outside, or replace it if necessary.
4. Install the air cleaner.
5. Install the removed parts in reverse order of removal.

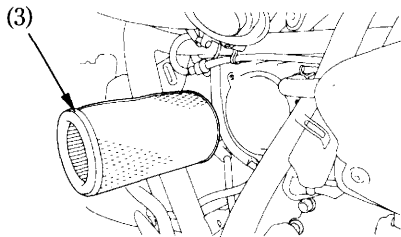

- (3) Air cleaner

## DRIVE CHAIN

Refer to the Safety Precautions on page 110.

The service life of the drive chain is dependent upon proper lubrication and adjustment. Poor maintenance can cause premature wear or damage to the drive chain and sprockets.

The drive chain should be checked and lubricated as part of the Pre-ride Inspection (page 93). Under severe usage, or when the motorcycle is ridden in unusually dusty or muddy areas, more frequent maintenance will be necessary.

### Inspection:

1. Turn the engine off, place the motorcycle on its side stand and shift the transmission into neutral.
2. Check slack in the lower drive chain run midway between the sprockets. Drive chain slack should be adjusted to allow the following vertical movement by hand:

25 – 35 mm (1.0 – 1.4 in)

3. Roll the motorcycle forward. Stop. Check the drive chain slack. Repeat this procedure several times. Drive chain slack should remain constant. If the chain is slack only in certain sections, some links are kinked and binding. Binding and kinking can frequently be eliminated by lubrication.

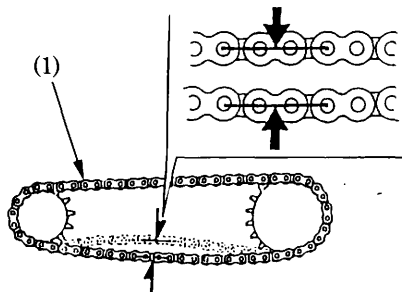

(1) Drive chain



4. Roll the motorcycle forward. Stop and place it on its side stand. Inspect the drive chain and sprockets for any of the following conditions:

#### DRIVE CHAIN

- \*Damaged Rollers
- \*Loose Pins
- \*Dry or Rusted Links
- \*Kinked or Binding Links
- \*Excessive Wear
- \*Improper Adjustment
- \*Damaged or Missing O-rings

#### SPROCKETS

- \*Excessively Worn Teeth
- \*Broken or Damaged Teeth

A drive chain with damaged rollers, loose pins, or missing O-rings must be replaced. A chain which appears dry, or shows signs of rust, requires supplementary lubrication. Kinked or binding links should be thoroughly lubricated and worked free. If links cannot be freed, the chain must be replaced.

Damaged sprocket  
Teeth

Replace

Worn sprocket  
Teeth

Replace

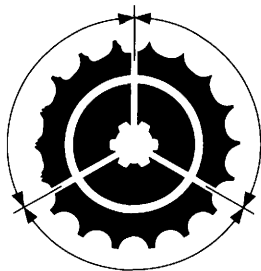

Normal sprocket Teeth

**GOOD**

### Adjustment:

Drive chain slack should be checked and adjusted, if necessary, every 1,000 km (600 miles). When operated at sustained high speeds or under conditions of frequent rapid acceleration, the chain may require more frequent adjustment.

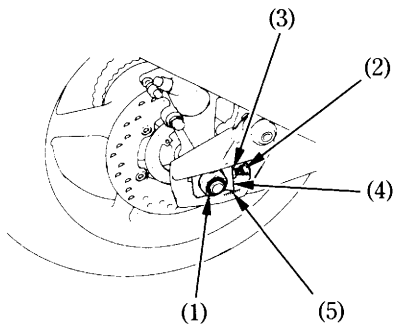

- (1) Axle nut
- (2) Lock nut
- (3) Adjusting bolts
- (4) Front edge of the adjuster plates
- (5) Corresponding scale

If the drive chain requires adjustment, the procedure is as follows:

1. Place the motorcycle on its side stand with the transmission in neutral and the ignition switch off.
2. Loosen the rear axle nut (1).
3. Loosen the lock nuts (2) on both adjusting bolts (3).
4. Turn both adjusting bolts an equal number of turns until the correct drive chain slack is obtained. Turn the adjusting bolts counterclockwise to tighten the chain. Turn the adjusting bolts clockwise and push the rear wheel toward the front to provide more slack. Adjust the chain slack at a point midway between the drive sprocket and the rear wheel sprocket. Rotate the rear wheel and recheck slack at other sections of the chain.

Chain slack should be:

25–35 mm (1.0–1.4 in)

5. Align the front edge of the adjuster plates (4) with the corresponding scale (5) graduations on the sides of both swingarms.

Both left and right marks should correspond. If the axle is misaligned, turn the left or right adjusting bolt until the marks correspond on the scale graduation on the swingarm and recheck chain slack.

6. Tighten the axle nut to specified torque.

Axle nut torque:

113 N·m (11.5 kgf·m , 83 lbf·ft)

If a torque wrench is not used for this installation, see your Honda dealer as soon as possible to verify proper assembly.

7. Tighten the adjusting bolts lightly by turning it counterclockwise, then tighten the lock nuts by holding the adjusting bolts with a spanner.
8. Recheck drive chain slack.

### Wear Inspection:

Check the chain wear label when adjusting the chain. If the red zone (7) on the label aligns with the index mark (6) on the swingarm after the chain has been adjusted to the proper slack, the chain is excessively worn and must be replaced. The proper slack is:

25–35 mm (1.0–1.4 in)

Damage to the bottom part of the frame may be caused by excessive drive chain slack of more than:

50 mm (2.0 in)

Replacement chain:

DID 50ZVM2

or

RK 50LFOZ2

This motorcycle has a staked master link drive chain which requires a special tool for cutting and staking. Do not use an ordinary master link with this chain. See your Honda dealer.

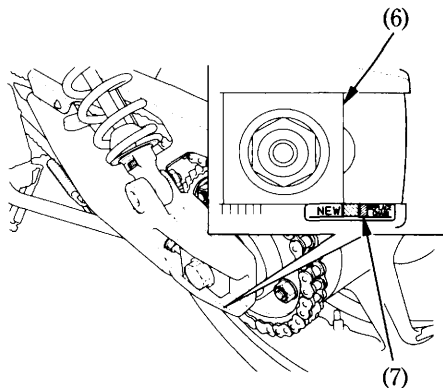

(6) Index mark

(7) Red zone

### Lubrication and Cleaning:

Lubricate every 1,000 km (600 miles) or sooner if chain appears dry.

The drive chain on this motorcycle is equipped with small O-rings between the link plates. These O-rings retain grease inside the chain to improve its service life.

The O-rings in this chain can be damaged by steam cleaning, high pressure washers, and certain solvents. Clean the side surfaces of the chain with a dry cloth. Do not brush the rubber O-rings. Brushing will damage them. Wipe dry and lubricate only with SAE 80 or 90 gear oil. Commercial chain lubricants may contain solvents which could damage the rubber O-rings.

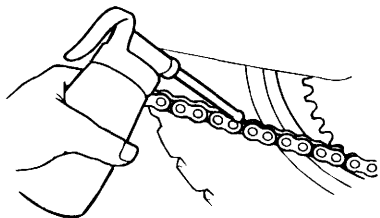

## DRIVE CHAIN SLIDER

Refer to the Safety Precautions on page 110.

Check the chain slider (1) for wear. The chain slider must be replaced if it is worn to the wear limit line (2). For replacement, see your Honda dealer.

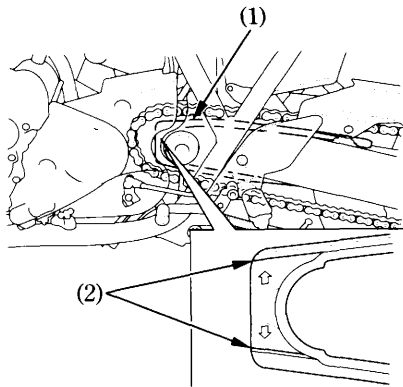

(1) Chain slider

(2) Wear limit line

## **FRONT AND REAR SUSPENSION INSPECTION**

Refer to the Safety Precautions on page 110.

1. Check the fork assembly by locking the front brake and pumping the fork up and down vigorously. Suspension action should be smooth and there must be no oil leakage.
2. Swingarm bearings should be checked by pushing hard against the side of the rear wheel while the motorcycle is on the center stand. Free play indicates worn bearings.
3. Carefully inspect all front and rear suspension fasteners for tightness.

## SIDE STAND

Refer to the Safety Precautions on page 110.

Perform the following maintenance in accordance with the maintenance schedule.

### Functional Check:

- Check the spring (1) for damage or loss of tension and the side stand assembly for freedom of movement.
- Check the side stand ignition cut-off system:
  1. Sit astride the motorcycle; put the side stand up and the transmission in neutral.
  2. Start the engine and with the clutch lever pulled in, shift the transmission into gear.
  3. Lower the side stand. The engine should stop as you put the side stand down.

If the side stand system does not operate as described, see your Honda dealer for service.

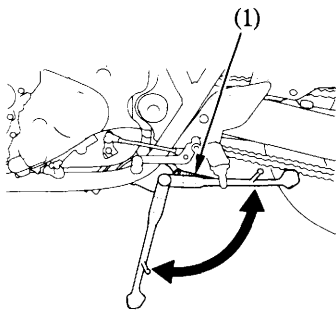

(1) Side stand spring



## WHEEL REMOVAL

Refer to the Safety Precautions on page 110.

This motorcycle is equipped with a side stand only. Therefore, if front or rear wheel removal is required, it will be necessary to raise the center of the motorcycle with a jack or other firm support. If none is available, see your Honda dealer for this service.

### Front Wheel Removal

1. Raise the front wheel off the ground by placing a support block under the engine.
2. Remove the speed sensor guide (1) from the right fork leg by removing the bolts (2).
3. Cover both sides of the front wheel with a protective tape (3) or equivalent.
4. Remove the right and left caliper assemblies (4) from the fork leg by removing the fixing bolts (5).

To avoid damage to the brake hose, support the caliper assembly so that it doesn't hang from the hose. Do not twist the brake hose.

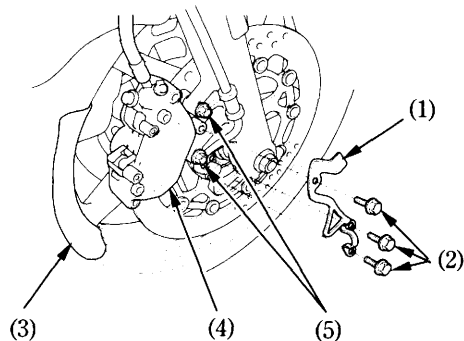

- (1) Speed sensor guide
- (2) Bolts
- (3) Protective tape
- (4) Brake caliper assembly
- (5) Fixing bolts

Do not depress the brake lever when the caliper assembly is removed. The caliper pistons will be forced out of the cylinders with subsequent loss of brake fluid. If this occurs, servicing of the brake system will be necessary. See your Honda dealer for this service.

5. Loosen the right and left axle pinch bolts (3), and remove the front axle bolt (4).
6. Withdraw the front axle shaft (5) and remove the front wheel.

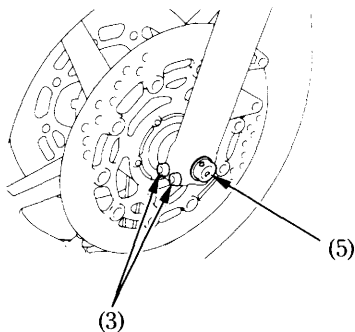

- (3) Axle pinch bolts  
(5) Front axle

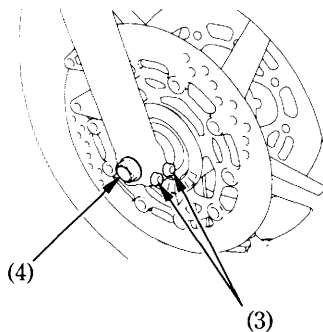

- (4) Axle bolt

### Installation:

1. Position the front wheel between the fork legs and insert the axle from the left side, through the left fork leg and wheel hub.
2. Align the index line ( 6 ) of the axle shaft with the surface ( 7 ) of fork leg.
3. Tighten the axle pinch bolts on the left fork leg to the specified torque:  
22 N·m (2.2 kgf·m , 16 lbf·ft)
4. Tighten the axle bolt to the specified torque.

Front axle torque :

59 N·m (6.0 kgf·m , 43 lbf·ft)

5. Install the right and left caliper assemblies to the fork legs and tighten the fixing bolts to the specified torque:  
31 N·m (3.2 kgf·m , 23 lbf·ft)

To avoid damaging the brake pads while installing the caliper assemblies, carefully fit both brake discs between the pads.

6. Operate the front brake and pump the fork several times.

Check for free wheel rotation after the brake lever is released. Recheck the wheel if the brake drags or if the wheel does not rotate freely.

7. Tighten the axle pinch bolts on the right fork leg to specified torque:  
22 N·m (2.2 kgf·m , 16 lbf·ft)

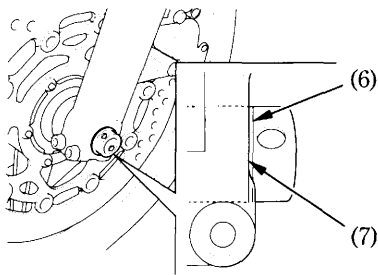

- (6) Index line  
(7) Surface

8. Visually check that the clearance (8) between each surface of the brake disc (9) and the brake caliper body (10) (not brake pads) is symmetrical.
9. **CB1300A/SA**  
Install the speed sensor guide assemblies to the right fork leg and tighten the fixing bolts to the specified torque:  
8.8 N·m (0.9 kgf·m , 6.5 lbf·ft)
10. Remove the protective tapes from the front wheel.

If a torque wrench was not used for installation, see your Honda dealer as soon as possible to verify proper assembly. Improper assembly may lead to loss of braking capacity.

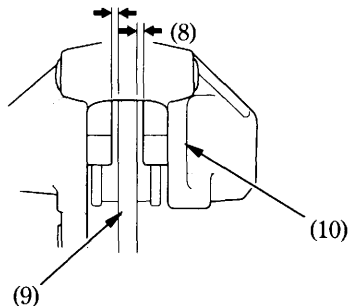

- (8) Clearance
- (9) Brake disc
- (10) Brake caliper body

## Rear Wheel Removal

1. Raise the rear wheel off the ground by placing a support block under the engine.
2. Loosen the rear axle nut (1).
3. Loosen the lock nut (2) and adjusting bolt (3).
4. Remove the rear axle nut and washer.
5. Remove the drive chain (4) from the driven sprocket by pushing the rear wheel forward.

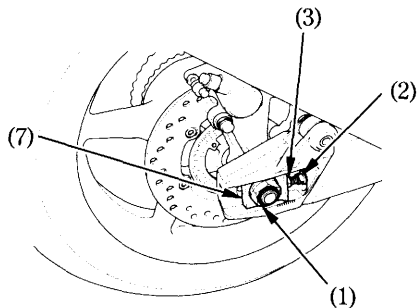

- (1) Rear axle nut      (3) Adjusting bolt  
(2) Lock nut          (7) Right chain adjust plate

6. Remove the rear axle shaft (5), rear wheel, left chain adjust plate (6), right chain adjust plate (7) and side collar from the swingarm.

Do not depress the brake pedal while the wheel is off the motorcycle. The caliper pistons will be forced out of the cylinders with subsequent loss of brake fluid. If this occurs, servicing of the brake system will be necessary. See your Honda dealer for this service.

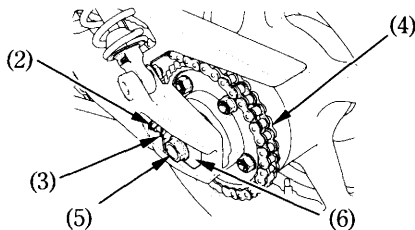

- (4) Drive chain      (6) Left chain adjust plate  
(5) Axle shaft

### Installation Notes:

- To install the rear wheel, reverse the removal procedure.
- Make sure that the slot (8) on the swingarm (9) is located in the lug (10) in the brake caliper.
- Tighten the axle nut to the specified torque:  
113 N·m (11.5 kgf·m , 83 lbf·ft)
- Adjust the drive chain.

When installing the wheel, carefully fit the brake disc between the brake pads to avoid damaging the pads.

After installing the wheel, apply the brake several times and then check if the wheel rotates freely. Recheck the wheel if the brake drags or if the wheel does not rotate freely.

If a torque wrench was not used for installation, see your Honda dealer as soon as possible to verify proper assembly. Improper assembly may lead to loss of braking capacity.

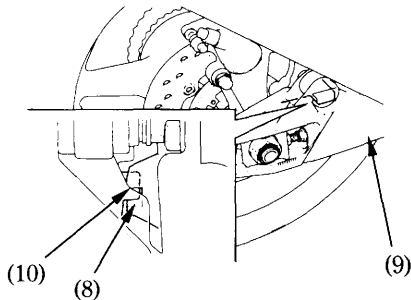

(8) Slot  
(9) Swingarm

(10) Lug

## **BRAKE PAD WEAR**

Refer to the Safety Precautions on page 110.

Brake pad wear depends upon the severity of usage, the type of riding, and road conditions. (Generally, the pads will wear faster on wet and dirty roads.)

Inspect the pads at each regular maintenance interval (page 113).

### **Front Brake**

Always inspect each pad in both right and left brake calipers.

Check the grooves (1) in each pad.

If either pad is worn to the bottom of the grooves, replace both pads as a set. See your Honda dealer for this service.

### **< FRONT BRAKE >**

Illustration shows left side, right side similar.

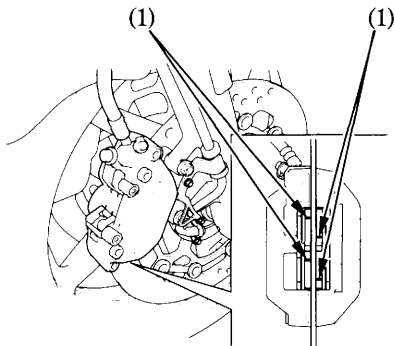

(1) Wear indicator grooves

## Rear Brake

Check the cutout (2) in each pad.

If either pad is worn to the cutout, replace both pads as a set. See your Honda dealer for this service.

< REAR BRAKE >

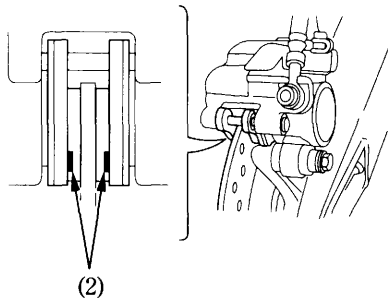

(2) Cutouts



## **BATTERY**

Refer to the Safety Precautions on page 110.

It is not necessary to check the battery electrolyte level or add distilled water as the battery is a maintenance-free (sealed) type. If your battery seems weak and/or is leaking electrolyte (causing hard starting or other electrical troubles), contact your Honda dealer.

### **NOTICE**

Your battery is a maintenance-free type and can be permanently damaged if the cap strip is removed.

## **⚠ WARNING**

The battery gives off explosive hydrogen gas during normal operation.

A spark or flame can cause the battery to explode with enough force to kill or seriously hurt you.

Wear protective clothing and a face shield, or have a skilled mechanic do the battery maintenance.

## Battery Removal CB1300A/SA

1. Remove the seat (page 79).
2. Pull up the clips (1).
3. Remove the engine control module (2).
4. Disconnect the negative (-) terminal lead (3) from the battery first, then disconnect the positive (+) terminal lead (4).
5. Pull out the battery (5) from the battery box.

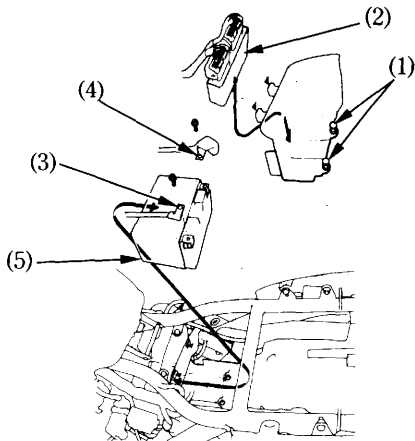

- (1) Clips
- (2) Engine control module
- (3) Negative (-) terminal lead
- (4) Positive (+) terminal lead
- (5) Battery

## Battery Removal CB1300/S

1. Remove the seat (page 79).
2. Remove the bolt (1).
3. Remove the engine control module (2).
4. Disconnect the negative (-) terminal lead (3) from the battery first, then disconnect the positive (+) terminal lead (4).
5. Pull out the battery (5) from the battery box.

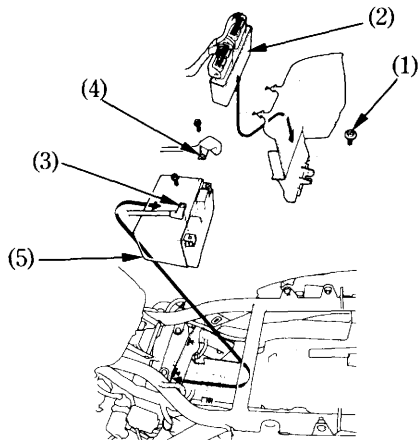

- (1) Bolt
- (2) Engine control module
- (3) Negative (-) terminal lead
- (4) Positive (+) terminal lead
- (5) Battery

## FUSE REPLACEMENT

Refer to the Safety Precautions on page 110.

When frequent fuse failure occurs, it usually indicates a short circuit or an overload in the electrical system. See your Honda dealer for repair.

### NOTICE

Never use a fuse with a different rating from that specified. Serious damage to the electrical system or a fire may result, causing a dangerous loss of lights or engine power.

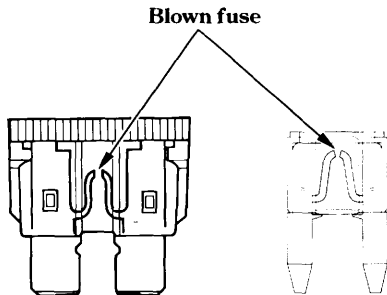

Fuse Box:  
**CBI300/S**

The fuse box is located behind the left side cover.

The specified fuses are:

10A, 20A

**CB1300A/SA**

The fuse boxes are located behind the left side cover.

The specified fuses are:

10A, 20A, 30A

1. Remove the left side cover (page 86 ).
2. Open the fuse box covers (1).
3. Pull out the old fuse and install a new fuse.  
The spare fuses (2) are located in the fuse box.
4. Close the fuse box cover and install the front seat.

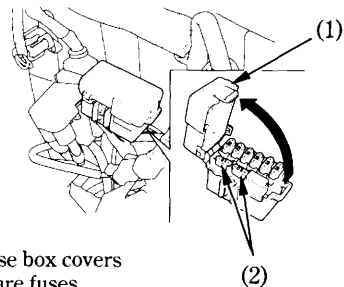
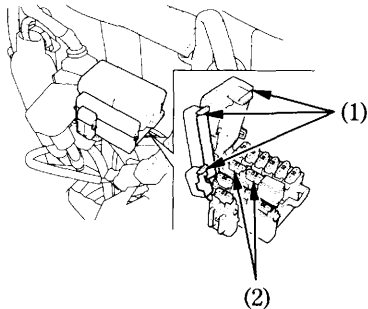

- (1) Fuse box covers  
(2) Spare fuses

### Main Fuse:

The main fuse (1) is located behind the left side cover.

The specified fuse is:

**30A**

1. Remove the left side cover (page 86 ).
2. Disconnect the wire connector (2 ) of the starter magnetic switch.
3. Pull out the old fuse and install a new fuse.  
The spare fuse (3) is located behind the starter magnetic switch.
4. Reconnect the connector and install the front seat.

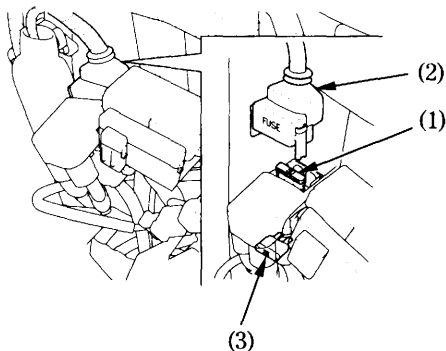

- (1) Main fuse
- (2) Wire connector
- (3) Spare main fuse

## STOPLIGHT SWITCH ADJUSTMENT

Refer to the Safety Precautions on page 110 .

Check the operation of the stoplight switch (1) at the right side behind the engine from time to time.

Adjustment is done by turning the adjusting nut (2). Turn the nut in the direction (A) if the switch operates too late and in direction (B) if the switch operates too soon.

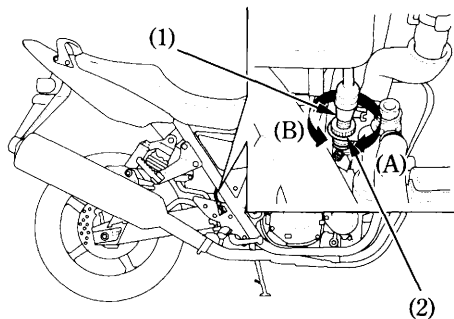

- (1) Stoplight switch
- (2) Adjusting nut

## **BULB REPLACEMENT**

Refer to the Safety Precautions on page 110.

The light bulb becomes very hot while the light is ON, and remains hot for a while after it is turned OFF. Be sure to let it cool down before servicing.

Do not put finger prints on the headlight bulb, as they may create hot spots on the bulb and cause it to break.

Wear clean gloves while replacing the bulb. If you touch the bulb with your bare hands, clean it with a cloth moistened with alcohol to prevent its early failure.

- Be sure to turn the ignition switch OFF when replacing the bulb.
- Do not use bulbs other than those specified.
- After installing a new bulb, check that the light operates properly.



## Headlight Bulb CB1300S/SA

1. Remove the left side cowl (page 88 ).
2. Pull off the socket (1) without turning.
3. Remove the dust cover (2).
4. Remove the bulb (4) while pressing down on the pin (3).
5. Pull out the bulb (4) without turning.
6. Install a new bulb in the reverse order of removal.

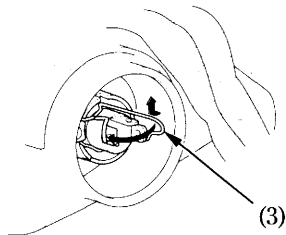
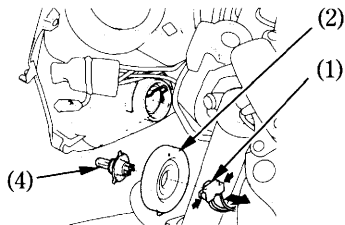

(1) Socket  
(2) Dust cover

(3) Pin  
(4) Bulb

## CB1300/A

1. Remove the screws (1) from the headlight case.
2. Gently pull the lower end of the headlight (2) forward and remove the headlight.
3. Disconnect the connectors (3).

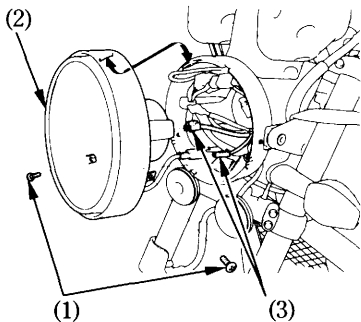

(1) Screws  
(2) Headlight

(3) Connectors

4. Remove the seat rubber (4).
5. Remove the bulb (5) while pressing down on the pin (6).
6. Install a new bulb in the reverse order of removal.

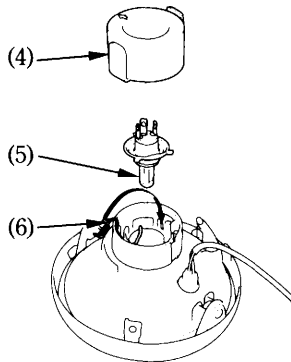

(4) Seat rubber  
(5) Headlight bulb

(6) Pin

## Position Light Bulb

(Except U type)

### CB1300S/SA

1. Remove the lower cowl (page 87 ).
2. Pull the position light socket (1) and remove it.
3. Pull out the bulb (2) without turning.
4. Install a new bulb in the reverse order of removal.

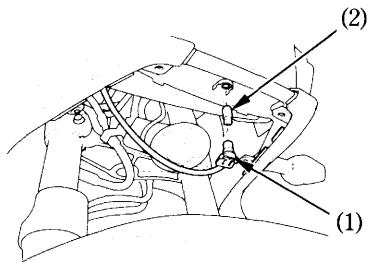

- (1) Socket  
(2) Position light bulb

## CB1300/A

1. Remove the headlight (1) (page 158).
2. Pull out the socket (2).
3. Slightly press the bulb (3) and turn it counterclockwise.
4. Install a new bulb in the reverse order of removal.

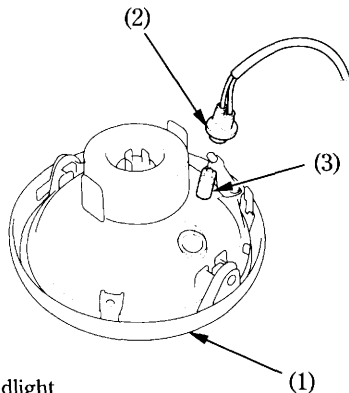

- (1) Headlight  
(2) Socket  
(3) Position light bulb

## Front/Rear Turn Signal Bulb

1. Remove the screw (1).
2. Remove the turn signal lens (2).
3. Slightly press the bulb (3) and turn it counterclockwise.
4. Install a new bulb in the reverse order of removal.

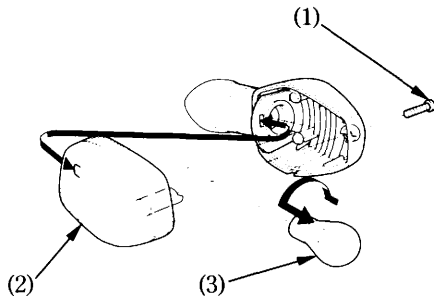

- (1) Screw
- (2) Turn signal lens
- (3) Bulb

## Stop/Taillight

Stop and tail light use some LED.

If there is a LED which is not turned on, see your Honda dealer for this service.

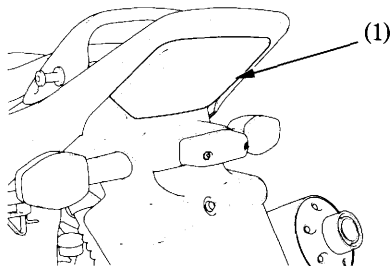

(1) Stoplight/Taillight

## License Light Bulb

1. Remove the license light lens (1) by removing the screws (2).
2. Pull out the bulb (3) without turning.
3. Install a new bulb in the reverse order of removal.

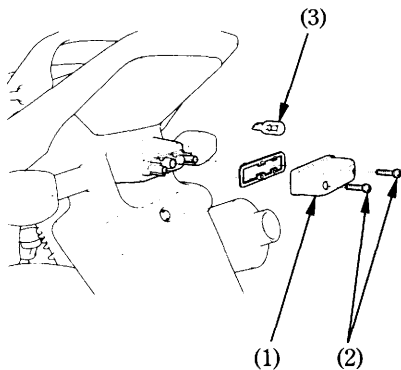

- (1) License light lens
- (2) Screws
- (3) Bulb

## CLEANING

Clean your motorcycle regularly to protect the surface finishes and inspect for damage, wear, and oil, coolant or brake fluid leakage.

Avoid cleaning products that are not specifically designed for motorcycle or automobile surfaces.

They may contain harsh detergents or chemical solvents that could damage the metal, paint, and plastic on your motorcycle.

If your motorcycle is still warm from recent operation, give the engine and exhaust system time to cool off.

We recommend avoiding the use of high pressure water spray (typical in coin-operated car washes).

### NOTICE

High pressure water (or air) can damage certain parts of the motorcycle.

### Washing the motorcycle

1. Rinse the motorcycle thoroughly with cool water to remove loose dirt.
2. Clean the motorcycle with a sponge or soft cloth using cool water.  
Avoid directing water to muffler outlets and electrical parts.
3. Clean the plastic parts using a cloth or sponge dampened with a solution of mild detergent and water. Rub the soiled area gently rinsing it frequently with fresh water.  
Take care to keep brake fluid or chemical solvents off the motorcycle.  
They will damage the plastic and painted surfaces.

The inside of the headlight lens may be clouded immediately after washing the motorcycle. Moisture condensation inside the headlight lens will disappear gradually by lighting the headlight in high beam. Run the engine while keeping the headlight on.

4. After cleaning, rinse the motorcycle thoroughly with plenty of clean water. Strong detergent residue can corrode alloy parts.
5. Dry the motorcycle, start the engine, and let it run for several minutes.
6. Test the brakes before riding the motorcycle. Several applications may be necessary to restore normal braking performance.
7. Lubricate the drive chain immediately after washing and drying the motorcycle.

Braking efficiency may be temporarily impaired immediately after washing the motorcycle.

Anticipate longer stopping distance to avoid a possible accident.

### **Finishing Touches**

After washing your motorcycle, consider using a commercially-available spray cleaner/polish or quality liquid or paste wax to finish the job. Use only a non-abrasive polish or wax made specifically for motorcycles or automobiles. Apply the polish or wax according to the instructions on the container.



### **Removing Road Salt**

The salt contained in the road surface freezing prevention medicine which a road was sprayed with in winter, and the seawater becomes the cause which rust occurs in.

Wash your motorcycle by the following point after it runs through such a place.

1. Clean the motorcycle using cool water (page 163 ).

Do not use warm water.

This worsens the effect of the salt.

2. Dry the motorcycle and the surface of the metal is protected with the wax.

### **Painted Aluminum Wheel Maintenance**

Aluminum may corrode from contact with dirt, mud, or road salt. Clean the wheels after riding through any of these substances. Use a wet sponge and mild detergent. Avoid stiff brushes, steel wool, or cleaners containing abrasives or chemical compounds.

After washing, rinse with plenty of water and dry with a clean cloth.

### **Exhaust Pipe And Muffler Maintenance**

The exhaust pipe and muffler is stainless steel but may become stained by mud or dust.

To remove mud or dust, use a wet sponge and a liquid kitchen abrasive, then rinse well with clean water. Dry with chamois or a soft towel.

If necessary, remove heat stains by using a commercially available fine texture compound. Then rinse by the same manner as removing mud or dust.

## STORAGE GUIDE

Extended storage, such as for winter, requires that you take certain steps to reduce the effects of deterioration from non-use of the motorcycle. In addition, necessary repairs should be made **BEFORE** storing the motorcycle; otherwise, these repairs may be forgotten by the time the motorcycle is removed from storage.

### STORAGE

1. Change the engine oil and filter.
2. Make sure the cooling system is filled with a 50/50 % antifreeze solution.
3. Empty the fuel tank into an approved petrol container using a commercially available hand siphon or an equivalent method. Spray the inside of the tank with an aerosol rust-inhibiting oil.  
Reinstall the fuel fill cap on the tank.

## **WARNING**

Petrol is highly flammable and explosive. You can be burned or seriously injured when handling fuel.

- Stop the engine and keep heat, sparks, and flame away.
- Refuel only outdoors.
- Wipe up spills immediately.

4. To prevent rusting in the cylinders, perform the following:
  - Remove the ignition coil connectors and ignition coils from the spark plugs. Using tape or string, secure the connectors to any convenient plastic body part so that they are positioned away from the spark plugs.
  - Remove the spark plugs from the engine and store them in a safe place. Do not connect the ignition coils to the ignition coil connectors.
  - Pour a tablespoon (15–20 cm<sup>3</sup>) of clean engine oil into each cylinder and cover the spark plug holes with a piece of cloth.
  - Crank the engine several times to distribute the oil.
  - Reinstall the spark plugs, ignition coils and ignition coil connectors.
5. Remove the battery. Store in an area protected from freezing temperatures and direct sunlight.  
Slow charge the battery once a month.
6. Wash and dry the motorcycle. Wax all painted surfaces. Coat chrome with rustinhibiting oil.
7. Lubricate the drive chain (page 137 ).
8. Inflate the tyres to their recommended pressures. Place the motorcycle on blocks to raise both tyres off the ground.
9. Cover the motorcycle (don't use plastic or other coated materials) and store in an unheated area, free of dampness with a minimum of daily temperature variation. Do not store the motorcycle in direct sunlight.

## **REMOVAL FROM STORAGE**

1. Uncover and clean the motorcycle.  
Change the engine oil if more than 4 months have passed since the start of storage.
2. Charge the battery as required. Install the battery.
3. Drain any excess aerosol rust-inhibiting oil from the fuel tank. Fill the fuel tank with fresh petrol.
4. Perform all Pre-ride Inspection checks (page 93 ).  
Test ride the motorcycle at low speeds in a safe riding area away from traffic.

## SPECIFICATIONS

### DIMENSIONS

Overall length	2,220 mm (87.4 in)
Overall width	790 mm (31.1 in)
Overall height	1,120 mm (44.1 in) ... CB1300/A 1,215 mm (47.8 in) ... CB1300S/SA
Wheelbase	1,515 mm (59.6 in)

### WEIGHT

Dry weight	224 kg (494 lbs) ... CB1300 230 kg (507 lbs) ... CB1300A 230 kg (507 lbs) ... CB1300S 236 kg (520 lbs) ... CB1300SA
------------	--

### CAPACITIES

Engine oil	After draining	3.7 ℓ (3.9 US qt , 3.3 Imp qt)
	After draining and oil filter change	3.9 ℓ (4.1 US qt , 3.4 Imp qt)
	After disassembly	4.8 ℓ (5.1 US qt , 4.2 Imp qt)
Fuel tank		21.0 ℓ (5.55 US gal , 4.62 Imp gal)
Cooling system capacity		3.0 ℓ (3.2 US qt , 2.6 Imp qt)
Passenger capacity		Operator and one passenger
Maximum weight capacity		188 kg (414 lbs)

## ENGINE

Bore and stroke	78.0 × 67.2 mm (3.07 × 2.65 in)
Compression ratio	9.6 : 1
Displacement	1,284.4 cm <sup>3</sup> (78.35 cu-in)
Spark plug	
Standard	DPR8EA-9 (NGK) or X24EPR-U9 (DENSO)
For extended high speed riding	DPR9EA-9 (NGK) or X27EPR-U9 (DENSO)
Spark plug gap	0,8–0,9 mm
Idle speed	1,000 ± 100 min <sup>-1</sup> (rpm)
Valve clearance (Cold)	Intake     0.16 mm (0.006 in) Exhaust    0.22 mm (0.009 in)

## CHASSIS AND SUSPENSION

Caster	25°00'
Trail	99 mm (3.9 in)
Tyre size, front	120/70ZR17M/C (58W)
Tyre size, rear	180/55ZR17M/C (73W)

## POWER TRANSMISSION

Primary reduction	1.652
Gear ratio, 1st	3.083
2nd	2.062
3rd	1.545
4th	1.272
5th	1.130
Final reduction	2.167



## **ELECTRICAL**

Battery  
Generator

12V – 12AH  
0.421 kW/5,000 min<sup>-1</sup> (rpm)

## **LIGHTS**

Headlight  
Stop/tail light  
Turn signal light  
  
License light  
Position light

Front  
Rear

12V – 60/55W  
LED  
12V – 21W  
12V – 21W  
12V – 5W  
12V – 5W ... Except U

## **FUSE**

Main fuse  
Other fuses

30A  
10A, 20A ... CB1300/S  
10A, 20A, 30A ... CB1300A/SA

## CATALYTIC CONVERTERS

This motorcycle is equipped with catalytic converters.

Each catalytic converter contains precious metals that serve as catalysts, promoting chemical reactions to convert the exhaust gasses without affecting the metals.

The catalytic converters act on HC, CO, and NOx. Replacement parts must be original Honda parts or equivalents.

The catalytic converters must operate at a high temperature for the chemical reactions to take place. They can set on fire any combustible materials that come near them. Park your motorcycle away from high grasses, dry leaves, or other flammables.

Defective catalytic converters contribute to air pollution, and can impair your engine's performance. Follow these guidelines to protect your motorcycle's catalytic converters.

- Always use unleaded petrol. Even a small amount of leaded petrol can contaminate the catalyst metals, making the catalytic converters ineffective.
- Keep the engine tuned-up.
- Have your motorcycle diagnosed and replaced if it is misfiring, backfiring, stalling or otherwise not running properly.

## **NOISE CONTROL SYSTEM (AUSTRALIA ONLY)**

**TAMPERING WITH THE NOISE CONTROL SYSTEM IS PROHIBITED:** Owners are warned that the law may prohibit : (a) The removal or rendering inoperative by any person other than for purposes of maintenance, repair, or replacement, of any device or element of design incorporated into any new vehicle for the purpose of noise control prior to its sale or delivery to the ultimate purchaser or while it is in use; and (b) the use of the vehicle after such device or element of design has been removed or rendered inoperative by any person.



# CB1300A (E,ED,EK)

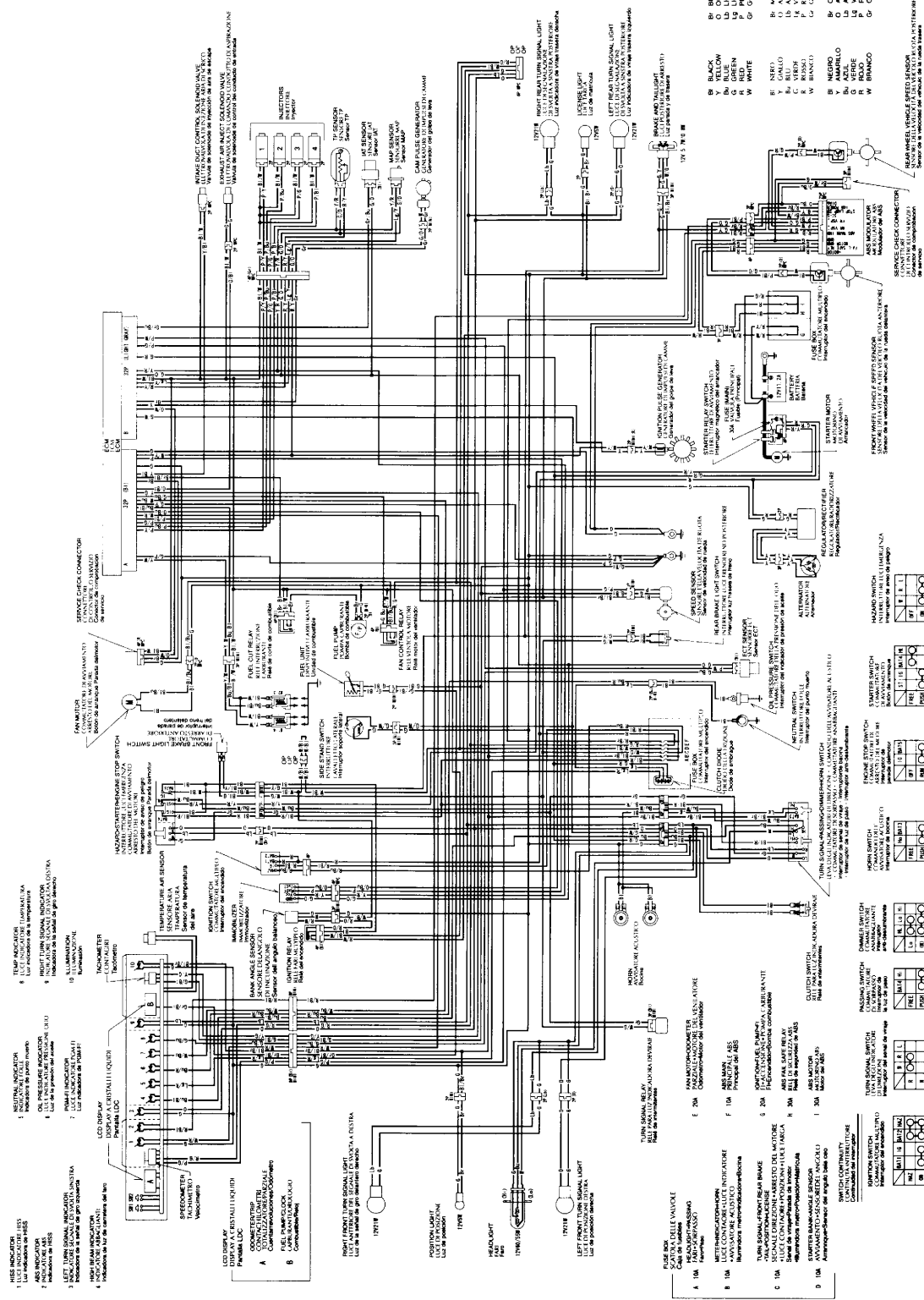

0030Z-MEJ-D100

# CB1300 (U)

- 1. REAR INDICATOR
- 2. LEFT TURN SIGNAL INDICATOR
- 3. HEAD LIGHT INDICATOR
- 4. TURN SIGNAL INDICATOR
- 5. FRONT TURN SIGNAL INDICATOR
- 6. TURN SIGNAL INDICATOR
- 7. TURN SIGNAL INDICATOR
- 8. FRONT TURN SIGNAL INDICATOR
- 9. TURN SIGNAL INDICATOR
- 10. TURN SIGNAL INDICATOR

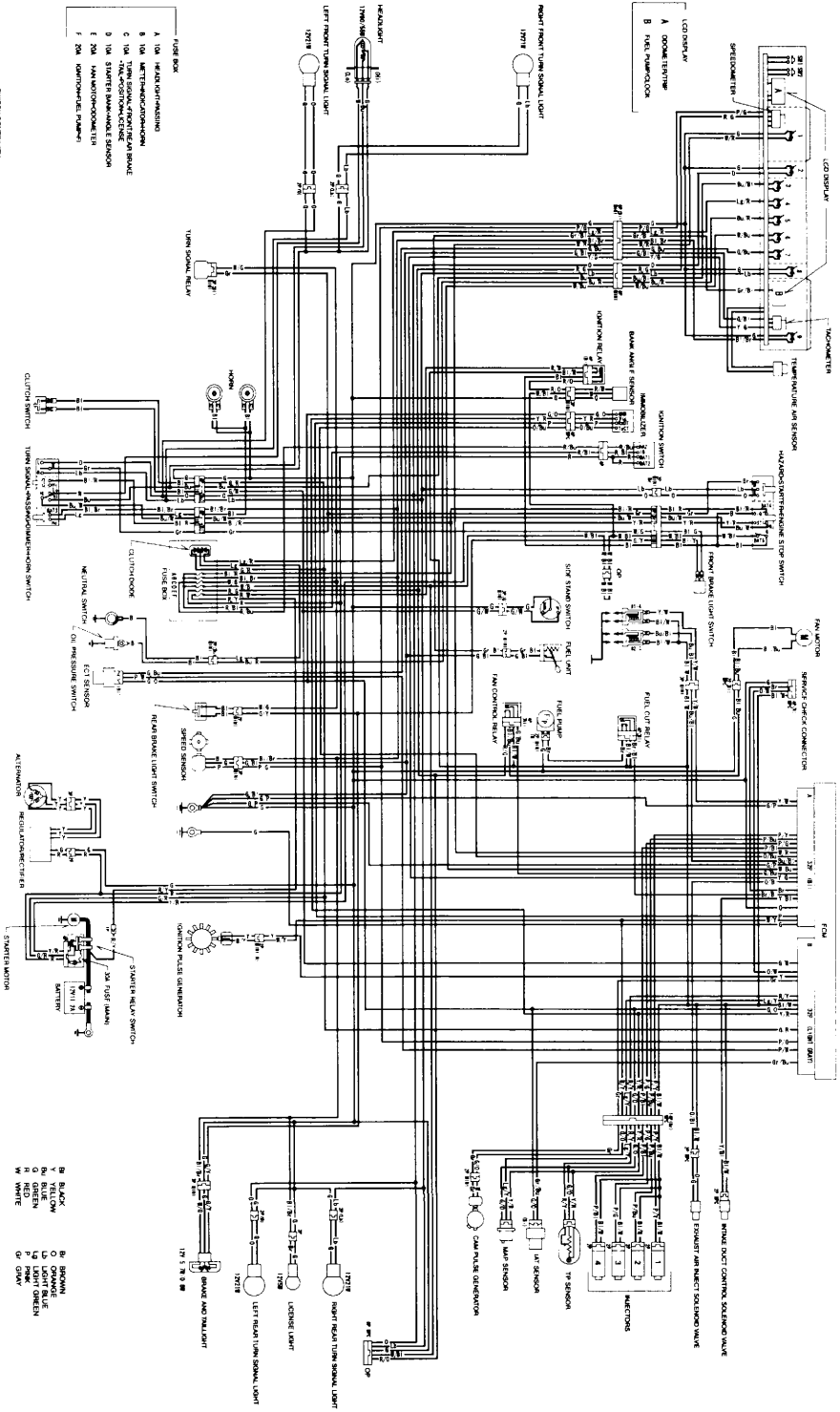

FUSE BOX

- A. 10A AMPERAGE
- B. 10A AMPERAGE
- C. 10A AMPERAGE
- D. 10A AMPERAGE
- E. 10A AMPERAGE
- F. 10A AMPERAGE
- G. 10A AMPERAGE
- H. 10A AMPERAGE
- I. 10A AMPERAGE
- J. 10A AMPERAGE
- K. 10A AMPERAGE
- L. 10A AMPERAGE
- M. 10A AMPERAGE
- N. 10A AMPERAGE
- O. 10A AMPERAGE
- P. 10A AMPERAGE
- Q. 10A AMPERAGE
- R. 10A AMPERAGE
- S. 10A AMPERAGE
- T. 10A AMPERAGE
- U. 10A AMPERAGE
- V. 10A AMPERAGE
- W. 10A AMPERAGE
- X. 10A AMPERAGE
- Y. 10A AMPERAGE
- Z. 10A AMPERAGE

SWITCH COMPONENTS

- 1. TURN SIGNAL SWITCH
- 2. TURN SIGNAL SWITCH
- 3. TURN SIGNAL SWITCH
- 4. TURN SIGNAL SWITCH
- 5. TURN SIGNAL SWITCH
- 6. TURN SIGNAL SWITCH
- 7. TURN SIGNAL SWITCH
- 8. TURN SIGNAL SWITCH
- 9. TURN SIGNAL SWITCH
- 10. TURN SIGNAL SWITCH
- 11. TURN SIGNAL SWITCH
- 12. TURN SIGNAL SWITCH
- 13. TURN SIGNAL SWITCH
- 14. TURN SIGNAL SWITCH
- 15. TURN SIGNAL SWITCH
- 16. TURN SIGNAL SWITCH
- 17. TURN SIGNAL SWITCH
- 18. TURN SIGNAL SWITCH
- 19. TURN SIGNAL SWITCH
- 20. TURN SIGNAL SWITCH
- 21. TURN SIGNAL SWITCH
- 22. TURN SIGNAL SWITCH
- 23. TURN SIGNAL SWITCH
- 24. TURN SIGNAL SWITCH
- 25. TURN SIGNAL SWITCH
- 26. TURN SIGNAL SWITCH
- 27. TURN SIGNAL SWITCH
- 28. TURN SIGNAL SWITCH
- 29. TURN SIGNAL SWITCH
- 30. TURN SIGNAL SWITCH
- 31. TURN SIGNAL SWITCH
- 32. TURN SIGNAL SWITCH
- 33. TURN SIGNAL SWITCH
- 34. TURN SIGNAL SWITCH
- 35. TURN SIGNAL SWITCH
- 36. TURN SIGNAL SWITCH
- 37. TURN SIGNAL SWITCH
- 38. TURN SIGNAL SWITCH
- 39. TURN SIGNAL SWITCH
- 40. TURN SIGNAL SWITCH
- 41. TURN SIGNAL SWITCH
- 42. TURN SIGNAL SWITCH
- 43. TURN SIGNAL SWITCH
- 44. TURN SIGNAL SWITCH
- 45. TURN SIGNAL SWITCH
- 46. TURN SIGNAL SWITCH
- 47. TURN SIGNAL SWITCH
- 48. TURN SIGNAL SWITCH
- 49. TURN SIGNAL SWITCH
- 50. TURN SIGNAL SWITCH

# CB1300 (E,ED,EK)

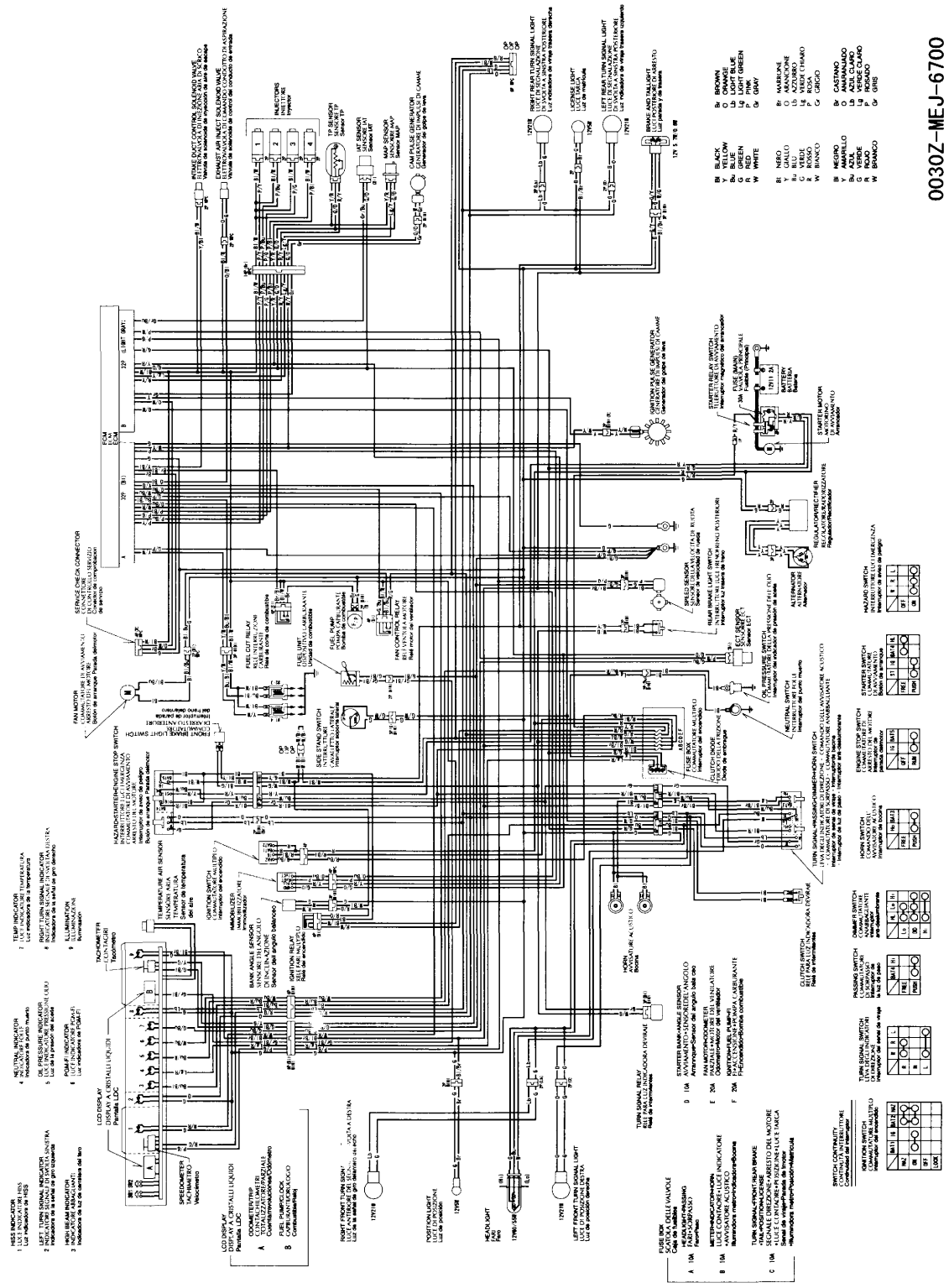

# CB1300SA (E, ED, EK)

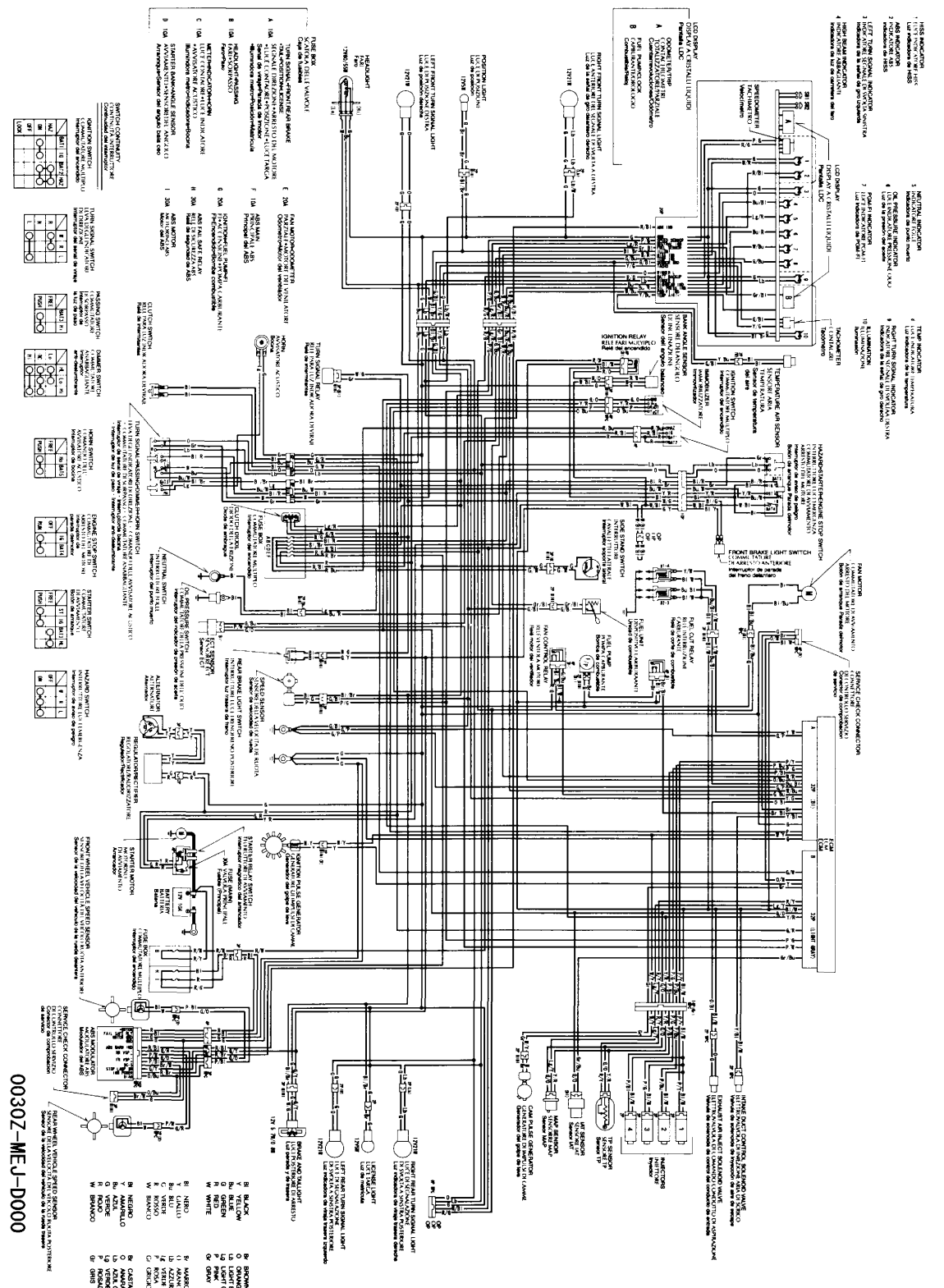

- 1. HEADLIGHT INDICATOR
- 2. HEADLIGHT INDICATOR
- 3. HEADLIGHT INDICATOR
- 4. HEADLIGHT INDICATOR
- 5. HEADLIGHT INDICATOR
- 6. HEADLIGHT INDICATOR
- 7. HEADLIGHT INDICATOR
- 8. HEADLIGHT INDICATOR
- 9. HEADLIGHT INDICATOR
- 10. HEADLIGHT INDICATOR
- 11. HEADLIGHT INDICATOR
- 12. HEADLIGHT INDICATOR
- 13. HEADLIGHT INDICATOR
- 14. HEADLIGHT INDICATOR
- 15. HEADLIGHT INDICATOR
- 16. HEADLIGHT INDICATOR
- 17. HEADLIGHT INDICATOR
- 18. HEADLIGHT INDICATOR
- 19. HEADLIGHT INDICATOR
- 20. HEADLIGHT INDICATOR
- 21. HEADLIGHT INDICATOR
- 22. HEADLIGHT INDICATOR
- 23. HEADLIGHT INDICATOR
- 24. HEADLIGHT INDICATOR
- 25. HEADLIGHT INDICATOR
- 26. HEADLIGHT INDICATOR
- 27. HEADLIGHT INDICATOR
- 28. HEADLIGHT INDICATOR
- 29. HEADLIGHT INDICATOR
- 30. HEADLIGHT INDICATOR

SWITCH CONTINUITY
1 2 3 4 5 6 7 8 9 10 11 12 13 14 15 16 17 18 19 20 21 22 23 24 25 26 27 28 29 30

TEMPERATURE INDICATOR
1 2 3 4 5 6 7 8 9 10 11 12 13 14 15 16 17 18 19 20 21 22 23 24 25 26 27 28 29 30

CLUTCH POSITION INDICATOR
1 2 3 4 5 6 7 8 9 10 11 12 13 14 15 16 17 18 19 20 21 22 23 24 25 26 27 28 29 30

GEAR POSITION INDICATOR
1 2 3 4 5 6 7 8 9 10 11 12 13 14 15 16 17 18 19 20 21 22 23 24 25 26 27 28 29 30

HEADLIGHT INDICATOR
1 2 3 4 5 6 7 8 9 10 11 12 13 14 15 16 17 18 19 20 21 22 23 24 25 26 27 28 29 30

CLUTCH POSITION INDICATOR
1 2 3 4 5 6 7 8 9 10 11 12 13 14 15 16 17 18 19 20 21 22 23 24 25 26 27 28 29 30

GEAR POSITION INDICATOR
1 2 3 4 5 6 7 8 9 10 11 12 13 14 15 16 17 18 19 20 21 22 23 24 25 26 27 28 29 30

HEADLIGHT INDICATOR
1 2 3 4 5 6 7 8 9 10 11 12 13 14 15 16 17 18 19 20 21 22 23 24 25 26 27 28 29 30

CLUTCH POSITION INDICATOR
1 2 3 4 5 6 7 8 9 10 11 12 13 14 15 16 17 18 19 20 21 22 23 24 25 26 27 28 29 30

GEAR POSITION INDICATOR
1 2 3 4 5 6 7 8 9 10 11 12 13 14 15 16 17 18 19 20 21 22 23 24 25 26 27 28 29 30

HEADLIGHT INDICATOR
1 2 3 4 5 6 7 8 9 10 11 12 13 14 15 16 17 18 19 20 21 22 23 24 25 26 27 28 29 30

CLUTCH POSITION INDICATOR
1 2 3 4 5 6 7 8 9 10 11 12 13 14 15 16 17 18 19 20 21 22 23 24 25 26 27 28 29 30

GEAR POSITION INDICATOR
1 2 3 4 5 6 7 8 9 10 11 12 13 14 15 16 17 18 19 20 21 22 23 24 25 26 27 28 29 30

HEADLIGHT INDICATOR
1 2 3 4 5 6 7 8 9 10 11 12 13 14 15 16 17 18 19 20 21 22 23 24 25 26 27 28 29 30

CLUTCH POSITION INDICATOR
1 2 3 4 5 6 7 8 9 10 11 12 13 14 15 16 17 18 19 20 21 22 23 24 25 26 27 28 29 30

GEAR POSITION INDICATOR
1 2 3 4 5 6 7 8 9 10 11 12 13 14 15 16 17 18 19 20 21 22 23 24 25 26 27 28 29 30

HEADLIGHT INDICATOR
1 2 3 4 5 6 7 8 9 10 11 12 13 14 15 16 17 18 19 20 21 22 23 24 25 26 27 28 29 30

CLUTCH POSITION INDICATOR
1 2 3 4 5 6 7 8 9 10 11 12 13 14 15 16 17 18 19 20 21 22 23 24 25 26 27 28 29 30



# CB1300S (U)

- 1. HIGH INDICATOR
- 2. LEFT TURN SIGNAL INDICATOR
- 3. RIGHT TURN SIGNAL INDICATOR
- 4. ILLUMINATION
- 5. OIL PRESSURE INDICATOR

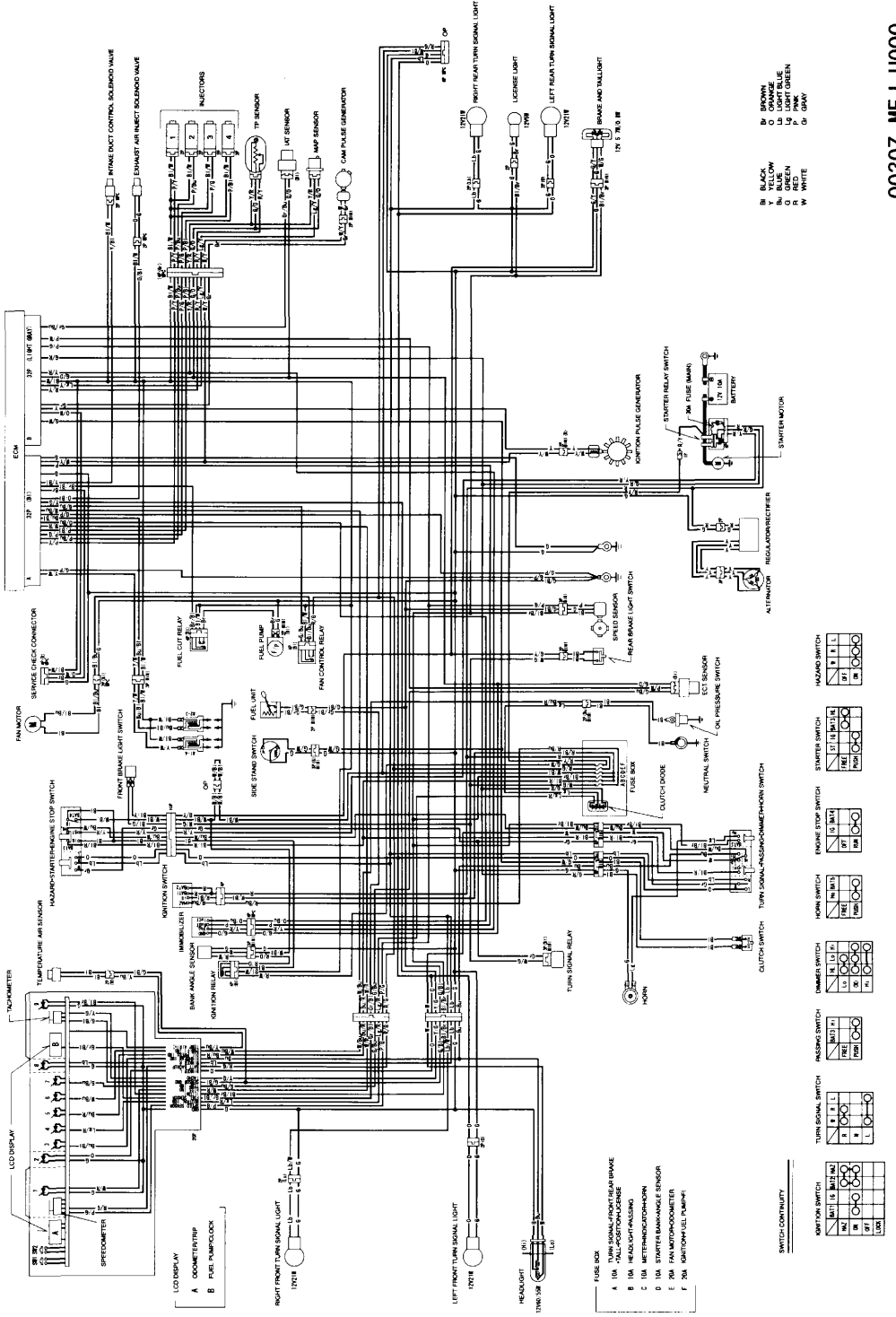

- B. BLACK
- BR. BROWN
- BL. BLUE
- LI. LIGHT BLUE
- GR. GREEN
- PK. PINK
- RD. RED
- W. WHITE
- GY. GRAY

SWITCH CONTINUED

