

TABLE OF CONTENTS

1	Before driving	Adjusting and operating features such as door locks, mirrors, and steering column.
2	When driving	Driving, stopping and safe-driving information.
3	Interior features	Air conditioning and audio systems, as well as other interior features for a comfortable driving experience.
4	Maintenance and care	Cleaning and protecting your vehicle, performing do-it-yourself maintenance, and maintenance information.
5	When trouble arises	What to do if the vehicle needs to be towed, gets a flat tire, or is involved in an accident.
6	Vehicle specifications	Detailed vehicle information.
	Index	Alphabetical listing of information contained in this manual.

1 Before driving

1-1. Key information
 Keys..... 30

1-2. Opening, closing and locking the doors and trunk
 Smart entry & start system 33
 Wireless remote control 51
 Doors 56
 Trunk..... 59

1-3. Adjustable components (seats, mirrors, steering wheel)
 Front seats 64
 Rear seats 68
 Head restraints 70
 Seat belts 72
 Steering wheel 79
 Anti-glare inside rear view mirror 80
 Outside rear view mirrors..... 81

1-4. Opening and closing the windows
 Power windows 84

1-5. Refueling

Opening the fuel tank cap 88

1-6. Theft deterrent system

Engine immobilizer system..... 92
 Double locking system 101

1-7. Safety information

Correct driving posture 103
 SRS airbag (Supplemental Restraint System airbag)..... 105
 Child restraint systems 134
 Installing child restraints..... 142
 Airbag manual on-off system..... 152

2 When driving

2-1. Driving procedures

Driving the vehicle 156
 Engine (ignition) switch (vehicles with a smart entry & start system) 169
 Engine (ignition) switch (vehicles without a smart entry & start system) 178
 Automatic transmission 181
 Manual Transmission 188
 Turn signal lever..... 191
 Parking brake 192
 Horn 193

2-2. Instrument cluster	
Gauges and meters	194
Indicators and warning lights	198
Multi-information display	203
2-3. Operating the lights and windshield wipers	
Headlight switch.....	208
Fog light switch	215
Windshield wipers and washer	217
2-4. Using other driving systems	
Cruise control.....	220
Driving assist systems	225
2-5. Driving information	
Cargo and luggage	231
Winter driving tips	233
Trailer towing	237

3 Interior features

3-1. Using the air conditioning system and defogger	
Manual air conditioning system	240
Automatic air conditioning system	248
Rear window and outside rear view mirror defoggers.....	256

3-2. Using the audio system	
Using the AUX/USB port	258
3-3. Using the interior lights	
Interior lights list	259
• Interior light	260
3-4. Using the storage features	
List of storage features.....	261
• Glove box.....	262
• Bottle holders	263
• Cup holders/console tray.....	264
3-5. Other interior features	
Sun visors	266
Vanity mirrors	267
Clock	268
Outside temperature display	269
Ashtray	270
Power outlets	271
Seat heaters	273
Floor mat	275
Trunk features	278

1

2

3

4

5

6

4 Maintenance and care

4-1. Maintenance and care
 Cleaning and protecting the vehicle exterior 282
 Cleaning and protecting the vehicle interior 286
 Cleaning and protecting the Alcantara® area 290

4-2. Maintenance
 Maintenance requirements..... 292

4-3. Do-it-yourself maintenance
 Do-it-yourself service precautions 295
 Hood 298
 Positioning a floor jack..... 300
 Engine compartment..... 302
 Tires 315
 Tire inflation pressure 324
 Wheels 326
 Air conditioning filter 329
 Wireless remote control/ electronic key battery..... 332
 Checking and replacing fuses 336
 Light bulbs 344

5 When trouble arises

5-1. Essential information
 Emergency flashers 364
 If your vehicle needs to be towed 365
 If you think something is wrong 372
 Fuel pump shut off system..... 373

5-2. Steps to take in an emergency
 If a warning light turns on or a warning buzzer sounds... 374
 If you have a flat tire (vehicles with a spare tire)..... 386
 If you have a flat tire (vehicles with an emergency tire puncture repair kit) 395
 If the engine will not start 411
 If the shift lever cannot be shifted from P 414

If you lose your keys	415
If the electronic key does not operate properly	416
If the battery is discharged	420
If your vehicle overheats	425
If the vehicle becomes stuck	428
If your vehicle has to be stopped in an emergency	430

6 Vehicle specifications

6-1. Specifications

Maintenance data (fuel, oil level, etc.)	434
Fuel information	447

6-2. Customization

Customizable features	449
-----------------------------	-----

Index

Abbreviation list.....	452
------------------------	-----

Alphabetical index	453
--------------------------	-----

What to do if...	462
------------------------	-----

1

2

3

4

5

6

Daytime running lights (vehicle with discharge headlights) P. 208

Headlights (high beam) P. 208

Front position lights P. 208

Headlights (low beam) P. 208

Windshield wipers P. 217

Outside rear view mirrors P. 81

Hood P. 298

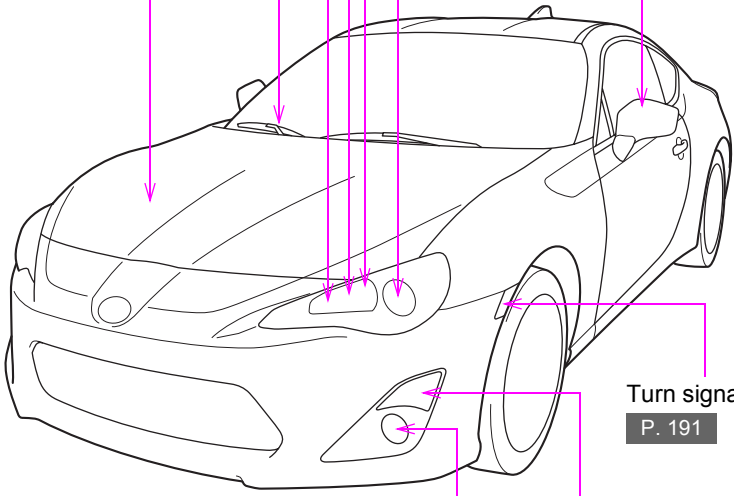

Turn signal lights P. 191

Turn signal lights P. 191

Front fog lights * P. 215

Daytime running lights (vehicles with halogen headlights) P. 208

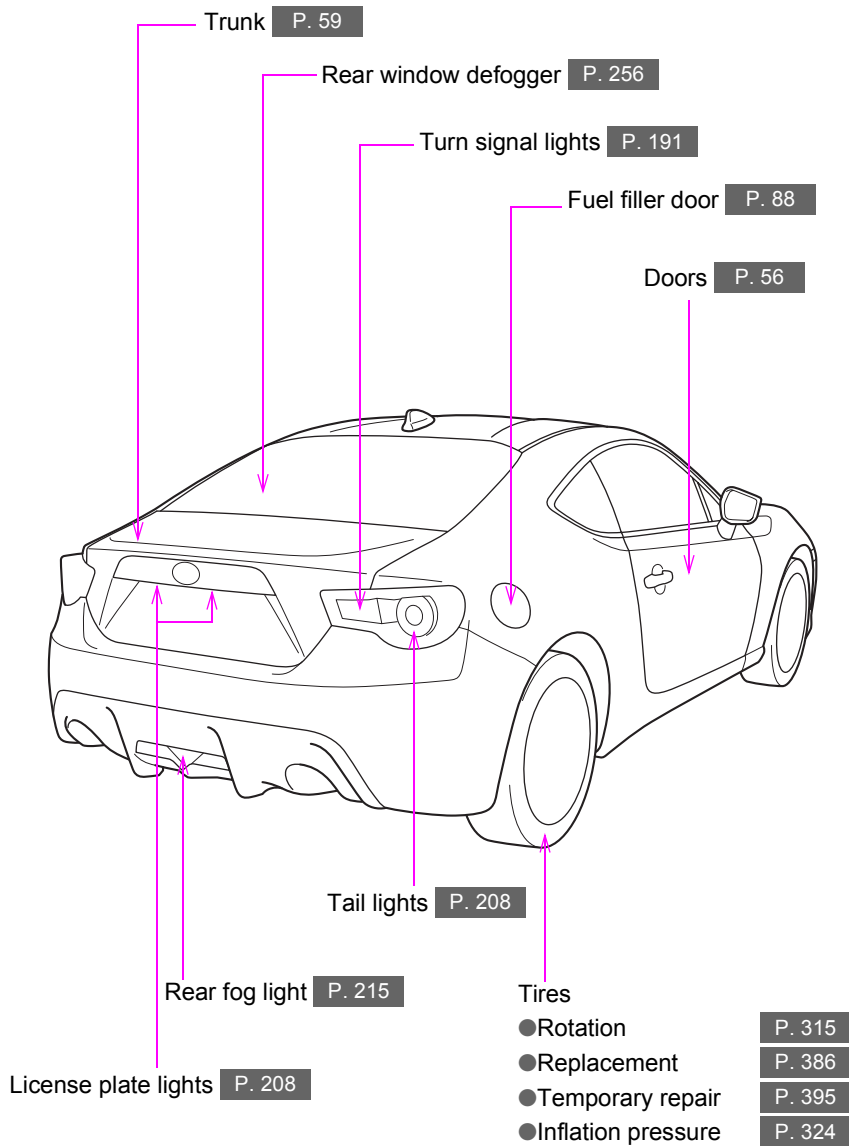

*: If equipped

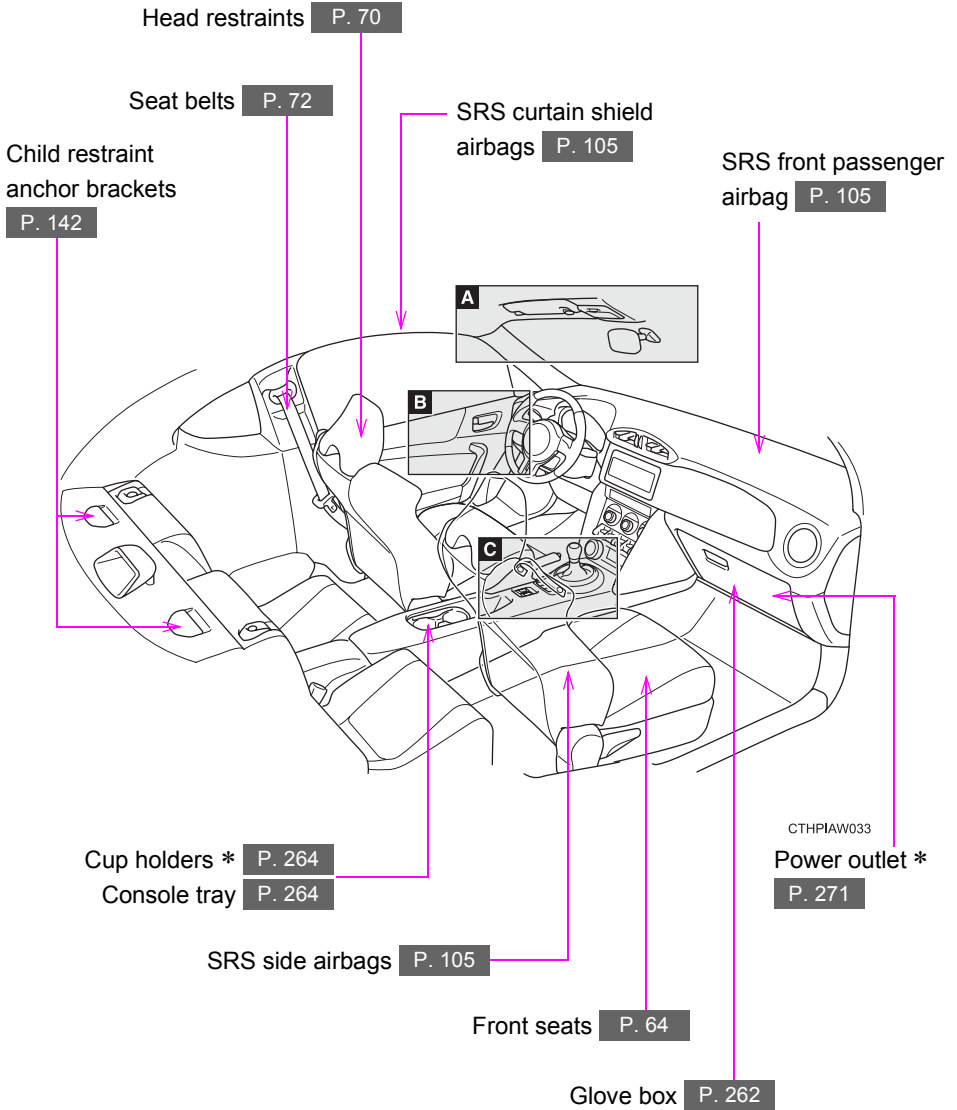

A

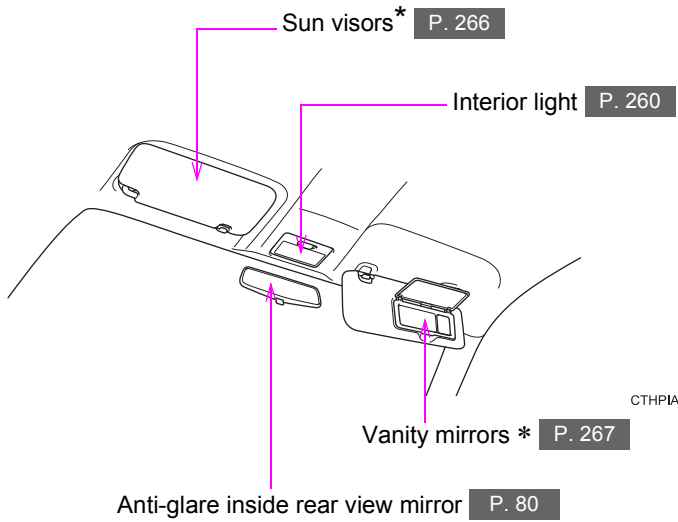

*: If equipped

*: NEVER use a rearward facing child restraint on a seat protected by an ACTIVE AIRBAG in front of it, DEATH or SERIOUS INJURY to the CHILD can occur. (→P. 150)



CTHPIAW115

B

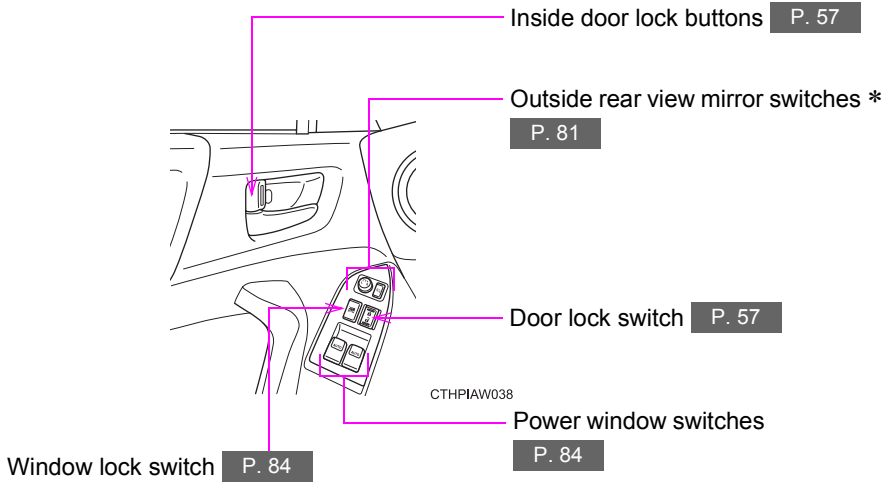

C

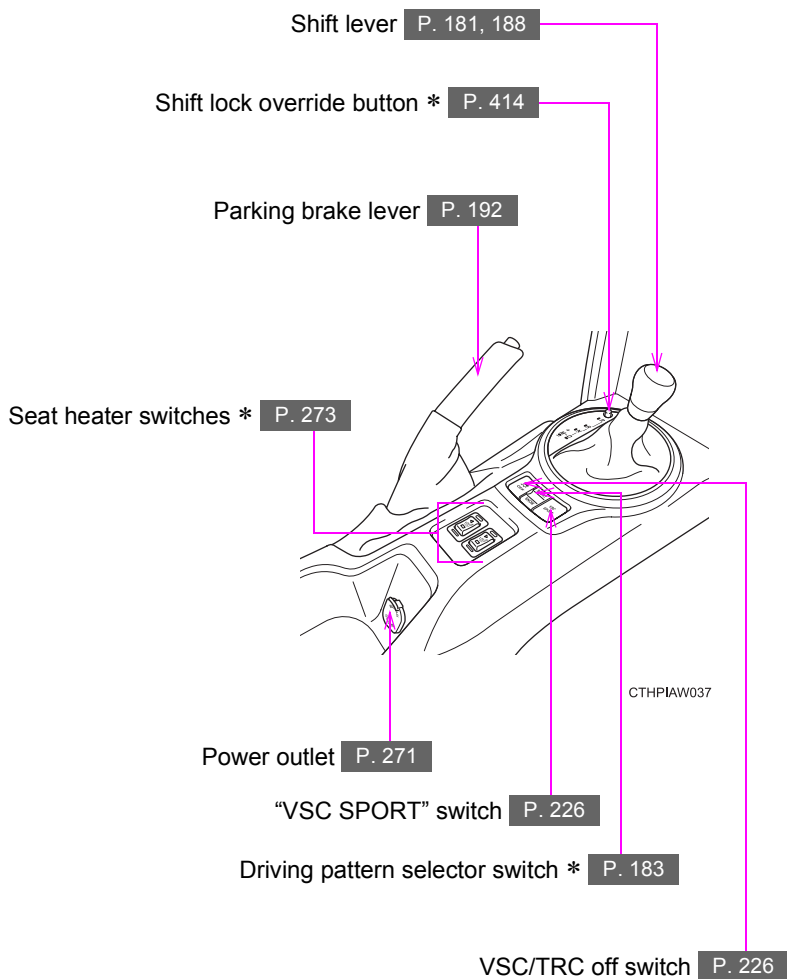

*: If equipped

Pictorial index

Instrument panel (Left-hand drive vehicles)

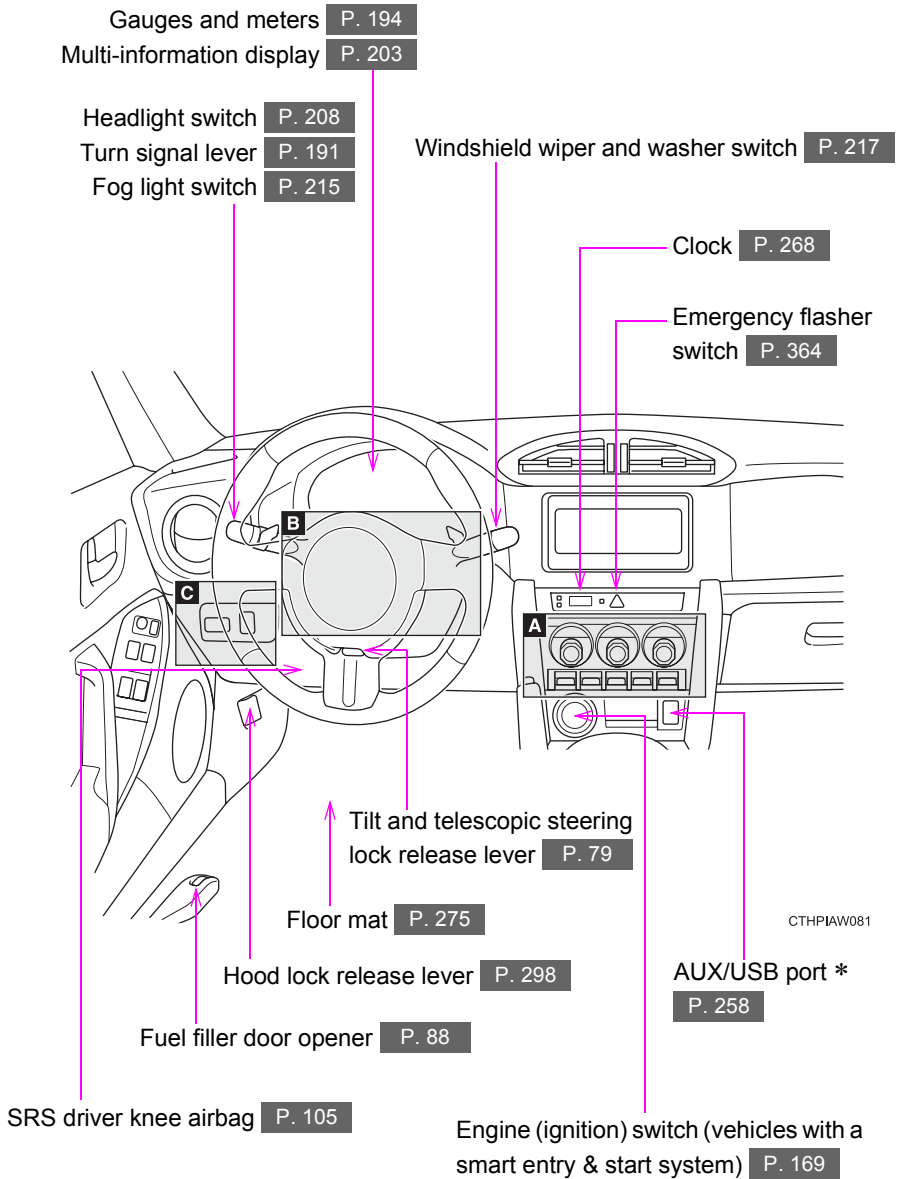

A**Vehicles with a manual air conditioning system**

Air conditioning system P. 240

Rear window and outside rear view mirror defoggers switch */rear window defogger switch * P. 256

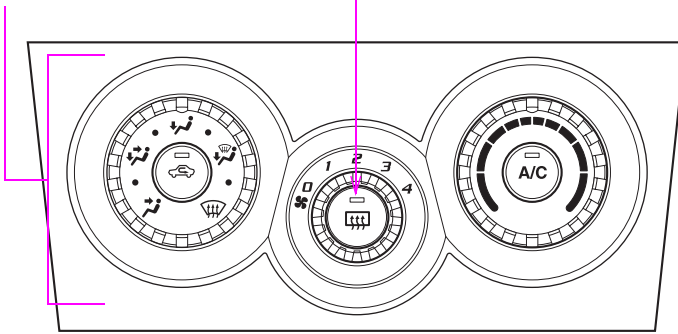

CTHPIAW016

Vehicles with an automatic air conditioning system

Air conditioning system P. 248

Rear window and outside rear view mirror defoggers switch P. 256

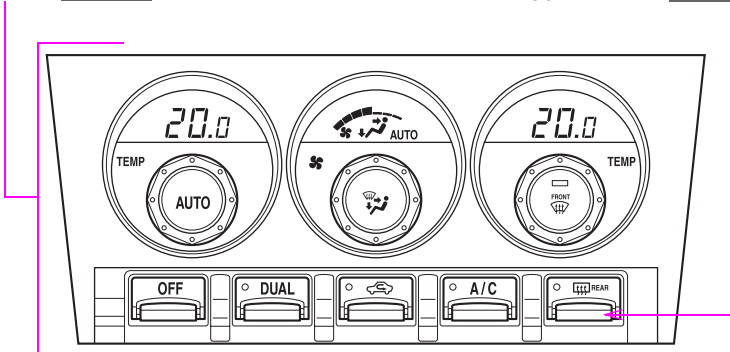

CTHPIAW055

*: If equipped

B

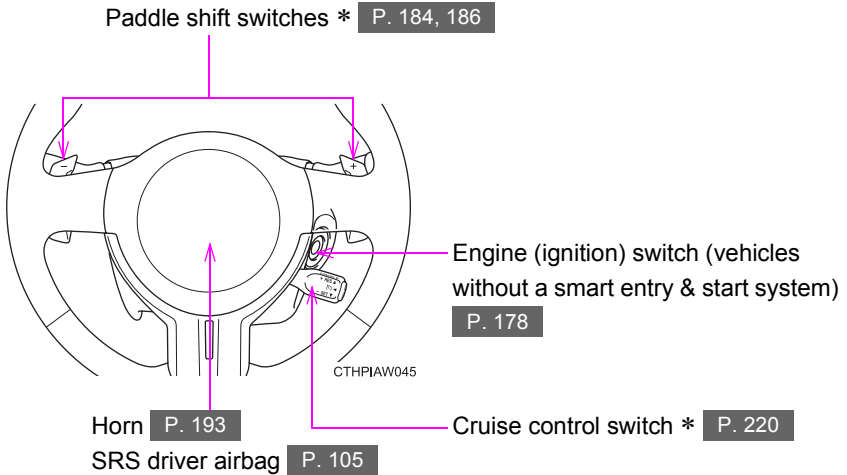

C

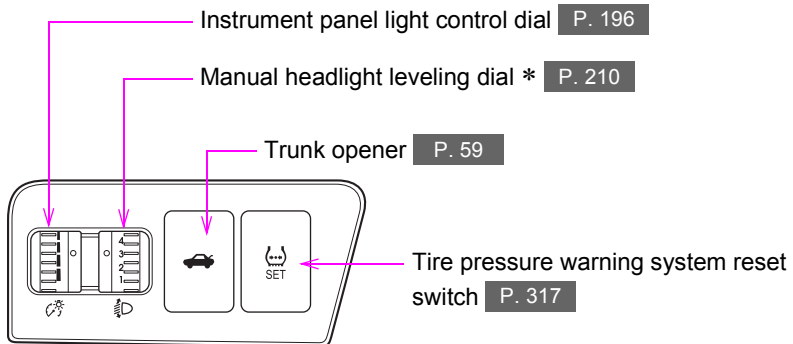

*: If equipped

Pictorial index

Interior (Right-hand drive vehicles)

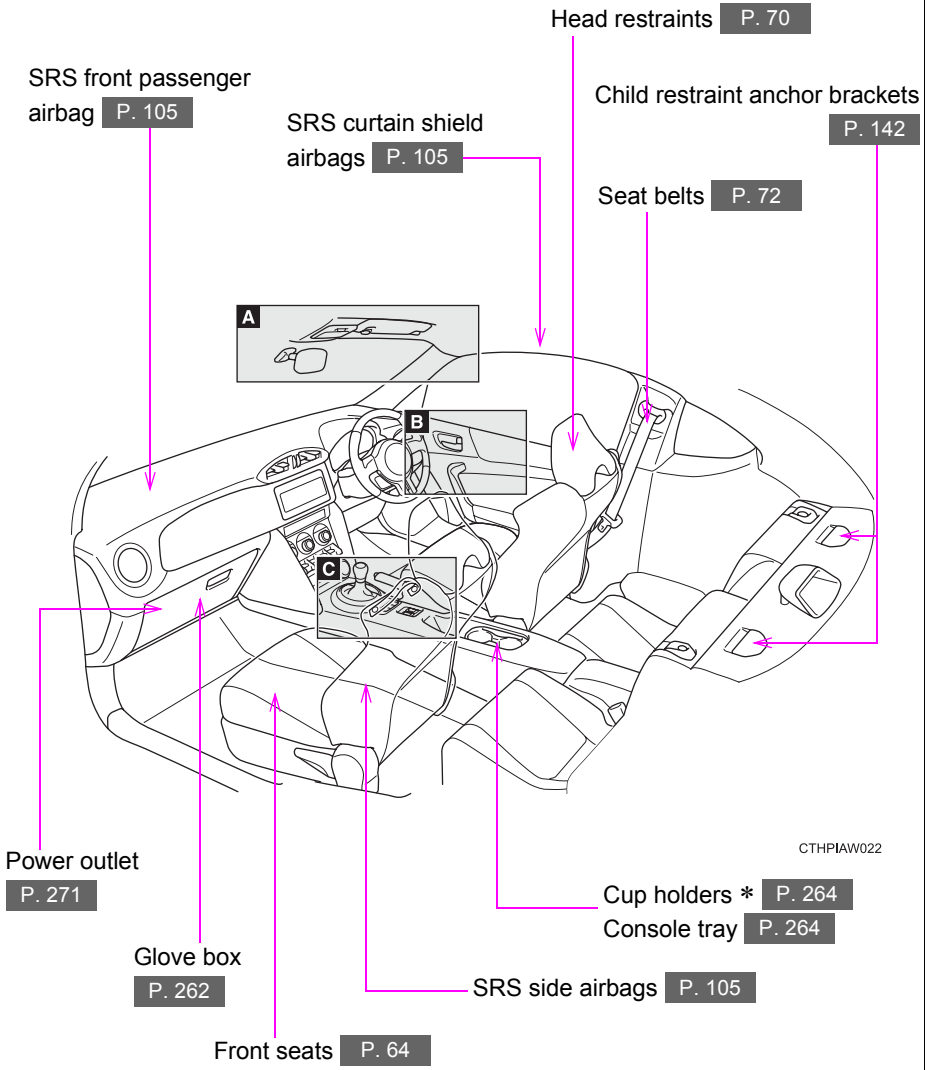

*: If equipped

A

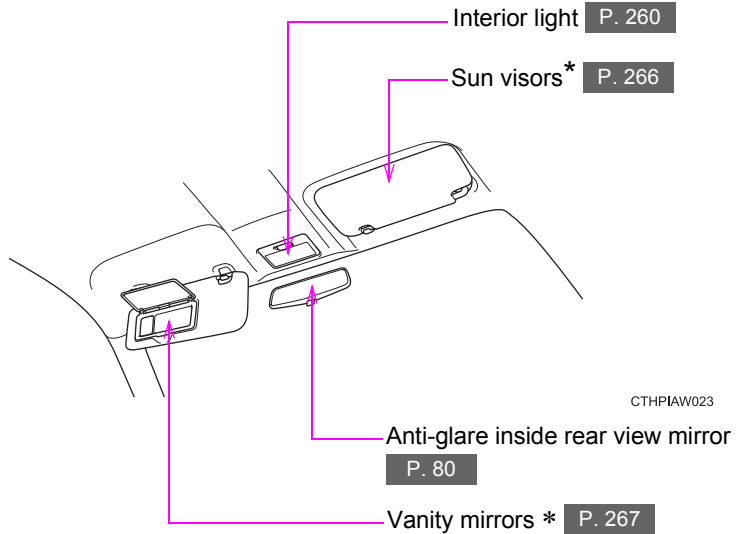

*: NEVER use a rearward facing child restraint on a seat protected by an ACTIVE AIRBAG in front of it, DEATH or SERIOUS INJURY to the CHILD can occur. (→P. 150)



CTHPIAW115

B

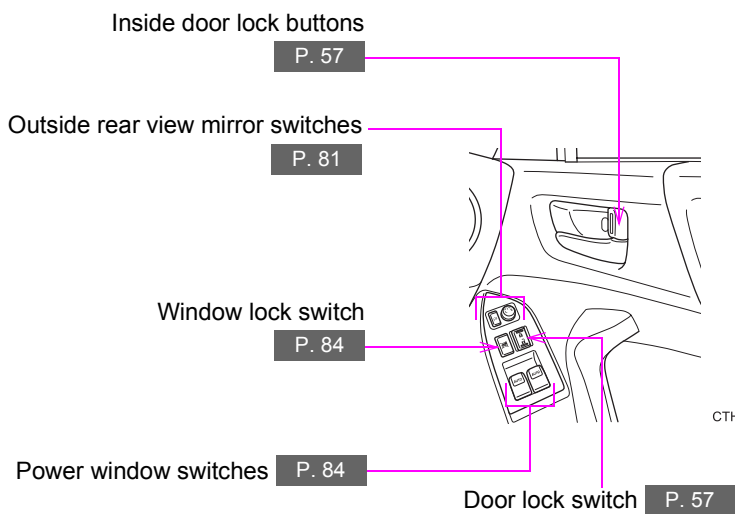

*: If equipped

C

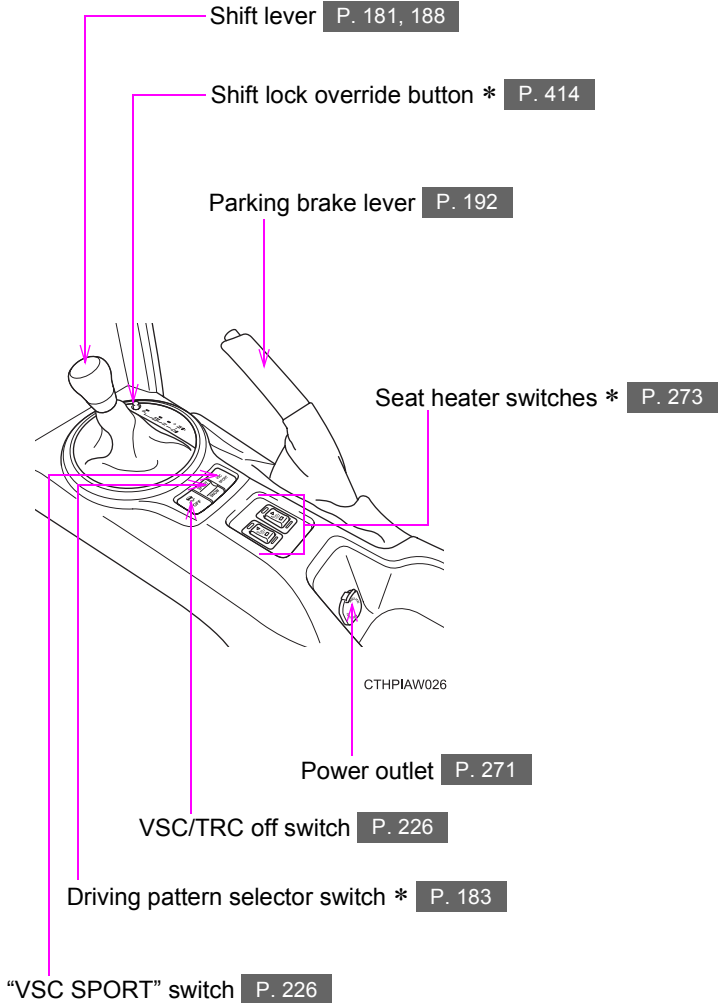

*: If equipped

Pictorial index

Instrument panel (Right-hand drive vehicles)

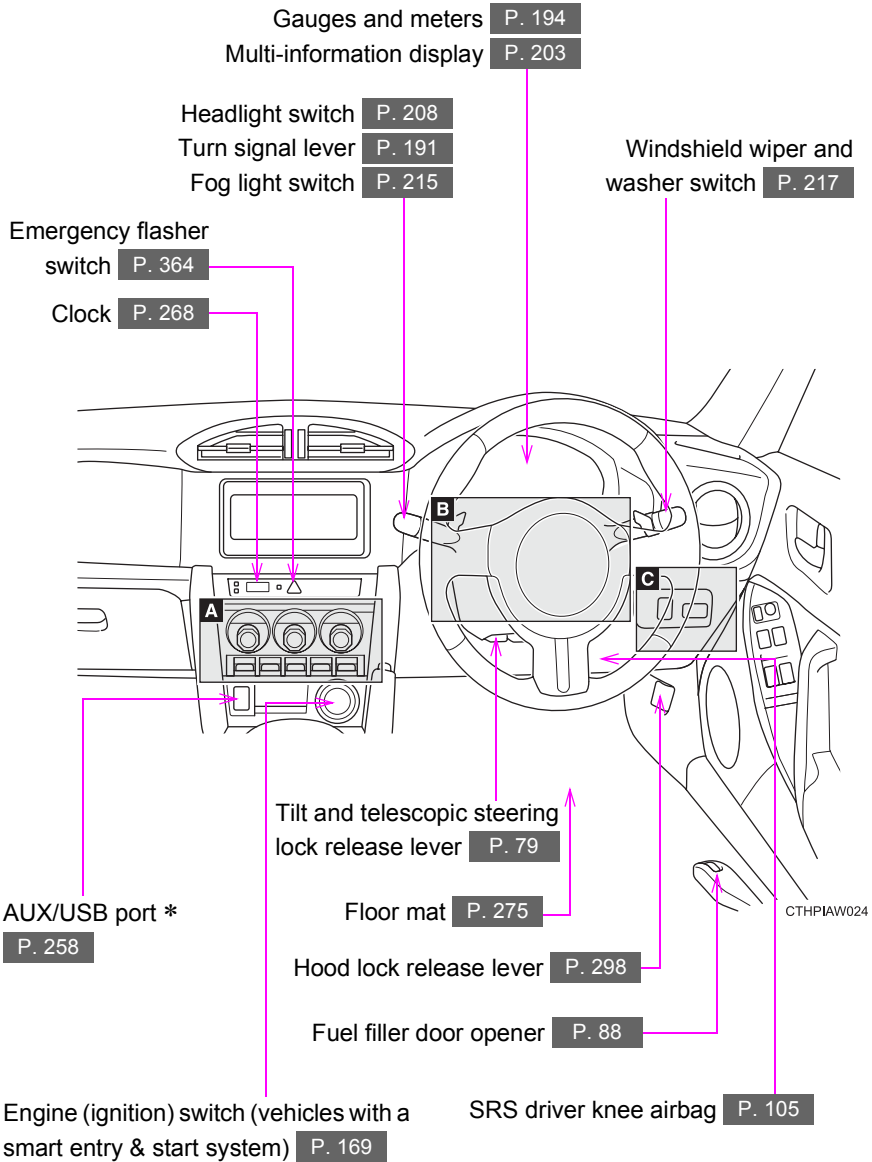

*: If equipped

A

Vehicles with a manual air conditioning system

Air conditioning system P. 240

Rear window and outside rear view mirror defoggers switch */rear window defogger switch * P. 256

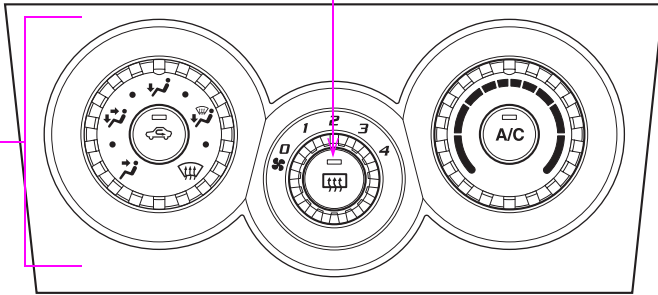

CTHPIAW016

Vehicles with an automatic air conditioning system

Rear window and outside rear view mirror defoggers switch P. 256

Air conditioning system P. 248

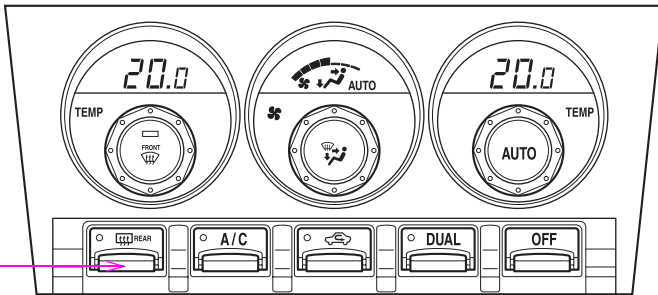

CTHPIAW050

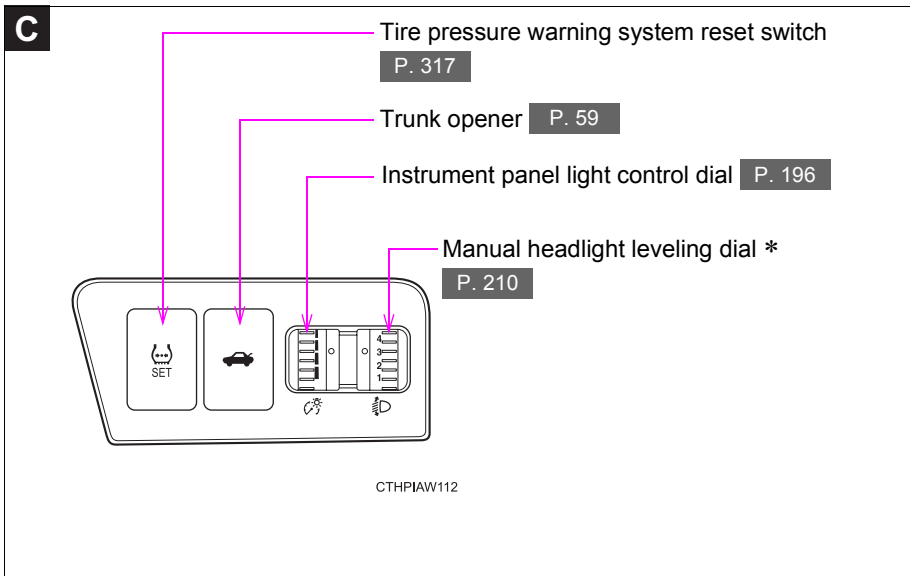
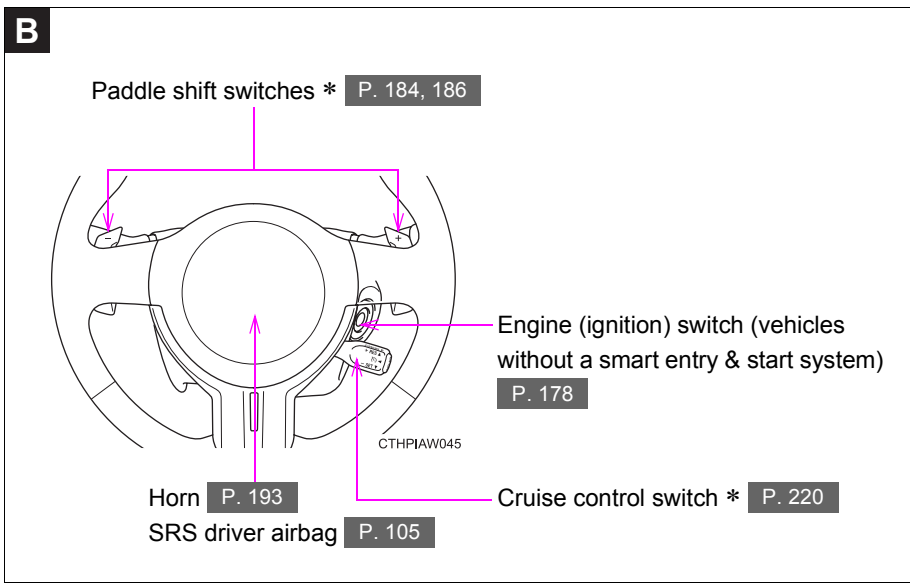

*: If equipped

For your information

Main Owner's Manual

Please note that this manual covers all models and all equipment, including options. Therefore, you may find some explanations for equipment not installed on your vehicle.

All specifications provided in this manual are current at the time of printing. However, because of the Toyota policy of continual product improvement, we reserve the right to make changes at any time without notice.

Depending on specifications, the vehicle shown in the illustrations may differ from your vehicle in terms of color and equipment.

Accessories, spare parts and modification of your Toyota

A wide variety of non genuine spare parts and accessories for Toyota vehicles are currently available in the market. Using these spare parts and accessories which are not genuine Toyota produces may adversely affect the safety of your vehicle, even though these parts may be approved by certain authorities in your country. Toyota Motor Corporation therefore cannot accept any liability or guarantee spare parts and accessories which are not genuine Toyota Products, nor for replacement or installation involving such parts.

This vehicle should not be modified with non genuine Toyota products. Modification with non genuine Toyota products could affect its performance, safety or durability, and may even violate governmental regulations. In addition, damage or performance problem resulting from the modification may not be covered under warranty.

Installation of an RF-transmitter system

The installation of an RF-transmitter system in your vehicle could affect electronic systems such as:

- Multiport fuel injection system/sequential multiport fuel injection system
- Cruise control system
- Anti-lock brake system
- SRS airbag system
- Seat belt pretensioner system

Be sure to check with any authorized Toyota dealer or repairer, or another duly qualified and equipped professional for precautionary measures or special instructions regarding installation of an RF-transmitter system.

Further information regarding frequency bands, power levels, antenna positions and installation provisions for the installation of RF-transmitters, is available on request at any authorized Toyota dealer or repairer, or another duly qualified and equipped professional.

Event data recorder

This vehicle is equipped with an event data recorder (EDR). The main purpose of an EDR is to record, in certain crash or near crash-like situations, such as an air bag deployment or hitting a road obstacle, data that will assist in understanding how a vehicle's systems performed. The EDR is designed to record data related to vehicle dynamics and safety systems for a short period of time, typically 30 seconds or less.

The EDR in this vehicle is designed to record such data as:

- How various systems in your vehicle were operating;
- How far (if at all) the driver was depressing the accelerator and/or brake pedal; and,
- How fast the vehicle was traveling.

These data can help provide a better understanding of the circumstances in which crashes and injuries occur.

NOTE: EDR data are recorded by your vehicle only if a non-trivial crash situation occurs; no data are recorded by the EDR under normal driving conditions and no personal data (e.g., name, gender, age, and crash location) are recorded. However, other parties, such as law enforcement, could combine the EDR data with the type of personally identifying data routinely acquired during a crash investigation.

To read data recorded by an EDR, special equipment is required, and access to the vehicle or the EDR is needed. In addition to the vehicle manufacturer, other parties, such as law enforcement, that have the special equipment, can read the information if they have access to the vehicle or the EDR.

● Disclosure of the EDR data

Toyota will not disclose the data recorded in an EDR to a third party except when:

- An agreement from the vehicle's owner (or the lessee for a leased vehicle) is obtained
- In response to an official request by the police, a court of law or a government agency
- For use by Toyota in a law suit

However, if necessary, Toyota may:

- Use the data for research on vehicle safety performance
- Disclose the data to a third party for research purposes without disclosing information about the specific vehicle or vehicle owner

Scrapping your Toyota

The SRS airbag and seat belt pretensioner devices in your Toyota contain explosive chemicals. If the vehicle is scrapped with the airbags and seat belt pretensioners left as they are, this may cause an accident such as fire. Be sure to have the systems of the SRS airbag and seat belt pretensioner removed and disposed of by a qualified service shop or by any authorized Toyota dealer or repairer, or another duly qualified and equipped professional, before you scrap your vehicle.

CAUTION

■ General precautions while driving

Driving under the influence: Never drive your vehicle when under the influence of alcohol or drugs that have impaired your ability to operate your vehicle. Alcohol and certain drugs delay reaction time, impair judgment and reduce coordination, which could lead to an accident that could result in death or serious injury.

Defensive driving: Always drive defensively. Anticipate mistakes that other drivers or pedestrians might make and be ready to avoid accidents.

Driver distraction: Always give your full attention to driving. Anything that distracts the driver, such as adjusting controls, talking on a cellular phone or reading can result in a collision with resulting death or serious injury to you, your occupants or others.

■ General precaution regarding children's safety

Never leave children unattended in the vehicle, and never allow children to have or use the key.

Children may be able to start the vehicle or shift the vehicle into neutral. There is also a danger that children may injure themselves by playing with the windows or other features of the vehicle. In addition, heat build-up or extremely cold temperatures inside the vehicle can be fatal to children.



Your vehicle contains batteries and/or accumulators. Do not discard them into the environment but cooperate with separate collection (Directive 2006/66/EC).

Symbols used throughout this manual

Cautions & Notices

CAUTION

This is a warning against something which, if ignored, may cause death or serious injury to people. You are informed about what you must or must not do in order to reduce the risk of death or serious injury to yourself and others.

NOTICE

This is a warning against something which, if ignored, may cause damage to the vehicle or its equipment. You are informed about what you must or must not do in order to avoid or reduce the risk of damage to your Toyota and its equipment.

Symbols used in illustrations



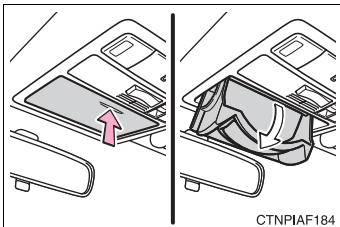

Safety symbol

The symbol of a circle with a slash through it means “Do not”, “Do not do this”, or “Do not let this happen.”



Arrows indicating operations

-  Indicates the action (pushing, turning, etc.) used to operate switches and other devices.
-  Indicates the outcome of an operation (e.g. a lid opens).

Before driving

1

- 1-1. Key information**
 - Keys..... 30
- 1-2. Opening, closing and locking the doors and trunk**
 - Smart entry & start system 33
 - Wireless remote control..... 51
 - Doors 56
 - Trunk 59
- 1-3. Adjustable components (seats, mirrors, steering wheel)**
 - Front seats..... 64
 - Rear seats 68
 - Head restraints 70
 - Seat belts..... 72
 - Steering wheel..... 79
 - Anti-glare inside rear view mirror 80
 - Outside rear view mirrors 81
- 1-4. Opening and closing the windows**
 - Power windows..... 84
- 1-5. Refueling**
 - Opening the fuel tank cap 88
- 1-6. Theft deterrent system**
 - Engine immobilizer system 92
 - Double locking system..... 101
- 1-7. Safety information**
 - Correct driving posture 103
 - SRS airbag (Supplemental Restraint System airbag) 105
 - Child restraint systems 134
 - Installing child restraints 142
 - Airbag manual on-off system 152

1-1. Key information

Keys

The following keys are provided with the vehicle.

Vehicles without a smart entry & start system

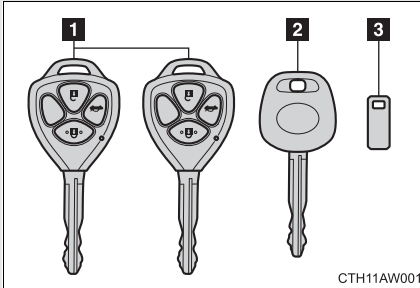

1 Keys (with a wireless remote control function)

Operating the wireless remote control function (→P. 51)

2 Key (without a wireless remote control function)

3 Key number plate

Vehicles with a smart entry & start system

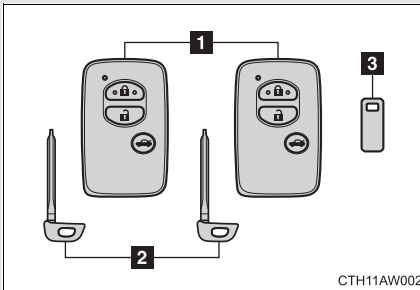

1 Electronic keys

- Operating the smart entry & start system (→P. 33)
- Operating the wireless remote control function (→P. 51)

2 Mechanical keys

3 Key number plate

Using the mechanical key (vehicles with a smart entry & start system)

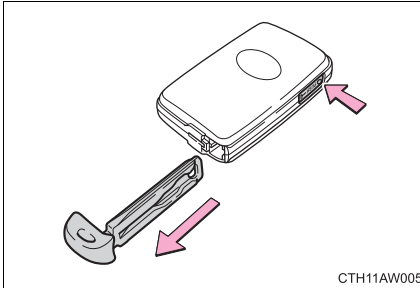

To take out the mechanical key, slide the release lever and take the key out.

After using the mechanical key, store it in the electronic key. Carry the mechanical key together with the electronic key. If the electronic key battery is depleted or entry function does not operate properly, you will need the mechanical key. (→P. 416)

■ Key number plate

Keep the plate in a safe place, not in the vehicle. In the event that a key (without a smart entry & start system) or mechanical key (with a smart entry & start system) is lost, a new key can be made by any authorized Toyota dealer or repairer, or another duly qualified and equipped professional, using the key number plate. (→P. 415)

■ When riding in an aircraft

When bringing a key with wireless remote control function onto an aircraft, make sure you do not press any buttons on the key while inside the aircraft cabin. If you are carrying the key in your bag etc., ensure that the buttons are not likely to be pressed accidentally. Pressing a button may cause the key to emit radio waves that could interfere with the operation of the aircraft.



NOTICE

■ To prevent key damage

Observe the following:

- Do not drop the keys, subject them to strong shocks or bend them.
- Do not expose the keys to high temperatures for a long period of time.
- Do not get the keys wet or wash them in an ultrasonic washer etc.
- Do not attach metallic or magnetic materials to the keys or place the keys close to such materials.
- Do not disassemble the keys.
- Do not attach a sticker or anything else to the surface of the key.
- Vehicles with a smart entry & start system: Do not place the keys near objects that produce magnetic fields, such as TVs, audio systems, induction cookers, or medical electrical equipment, such as low-frequency therapy equipment.

■ Carrying the electronic key on your person (vehicles with a smart entry & start system)

Carry the electronic key 10 cm (3.9 in.) or more away from electric appliances that are turned on. Radio waves emitted from electric appliances within 10 cm (3.9 in.) of the electronic key may interfere with the key, causing the key to not function properly.

■ In case of a smart entry & start system malfunction or other key-related problems (vehicles with a smart entry & start system)

Take your vehicle with all the electronic keys provided with your vehicle to any authorized Toyota dealer or repairer, or another duly qualified and equipped professional.

■ When a vehicle key is lost

If the key remains lost, the risk of vehicle theft increases significantly. Visit any authorized Toyota dealer or repairer, or another duly qualified and equipped professional immediately with all remaining keys that was provided with your vehicle.

1-2. Opening, closing and locking the doors and trunk Smart entry & start system*

The following operations can be performed simply by carrying the electronic key on your person, for example in your pocket.
(The driver should always carry the electronic key.)

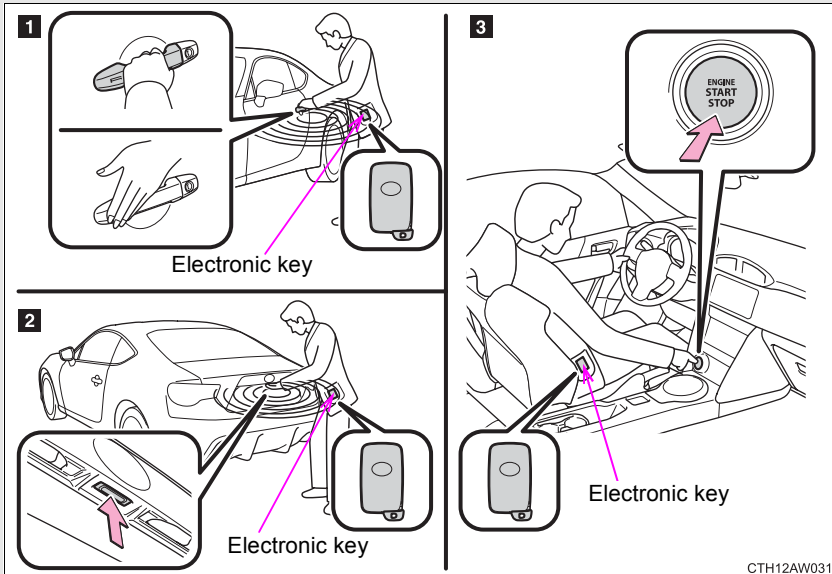

- 1** Unlocks and locks the doors (→P. 34)
- 2** Unlocks the trunk (→P. 35)
- 3** Starts the engine (→P. 169)

*: If equipped

Unlocking and locking the doors

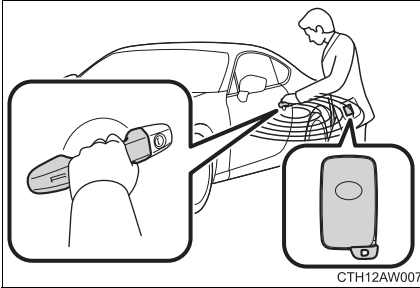

Vehicles without double locking system

Grip the handle to unlock the doors.

Vehicles with double locking system

Grip the driver's door handle to unlock the door. Grip the passenger's door handle to unlock all the doors.

Make sure to touch the sensor on the back of the handle.

The door cannot be unlocked for 3 seconds after the door is locked.

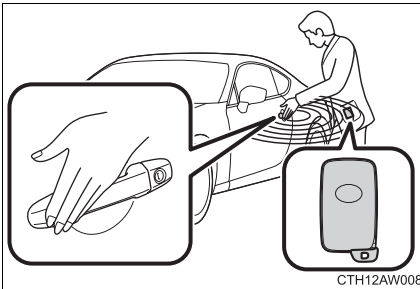

Touch the lock sensor (the indentation on the side of the door handle) to lock the doors.

Check that the door is securely locked.

Unlocking the trunk

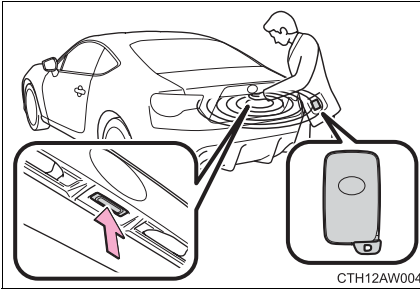

Press the button to unlock the trunk.

1

Before driving

Antenna location and effective range

■ Antenna location

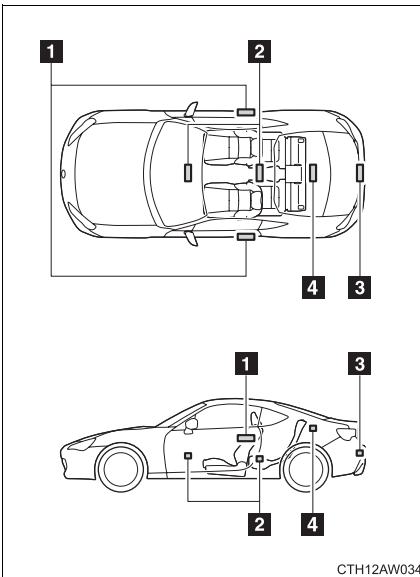

- 1 Antennas outside the cabin
- 2 Antennas inside the cabin
- 3 Antenna outside the trunk
- 4 Antenna inside the trunk

■ **Effective range (areas within which the electronic key is detected)**

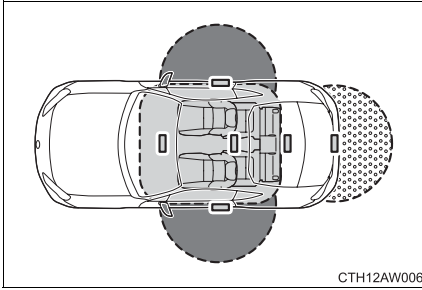

- When locking or unlocking the doors

The system can be operated when the electronic key is within about 0.4 - 0.8 m (1.3 - 2.6 ft.) of either of the outside door handles. (Only the doors detecting the key can be operated.)

- When unlocking the trunk

The system can be operated when the electronic key is within about 0.4 - 0.8 m (1.3 - 2.6 ft.) of the trunk release button.

- When starting the engine or changing “ENGINE START STOP” switch modes

The system can be operated when the electronic key is inside the vehicle.

■ Operation signals

The emergency flashers flash to indicate that the doors have been locked/unlocked. (Locked: once; Unlocked: twice)

■ When the door cannot be locked by the lock sensor

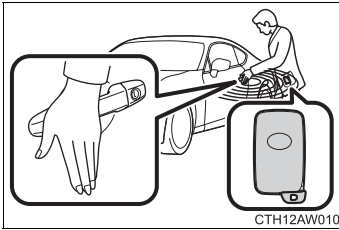

Use your palm to touch the lock sensor.

■ Door lock buzzer

If an attempt to lock the doors is made when a door is not fully closed, a buzzer sounds continuously. Fully close the door to stop the buzzer, and lock the vehicle once more.

■ Alarms and warning indicators

A combination of exterior and interior alarms as well as warning lights are used to prevent theft of the vehicle and unforeseeable accidents resulting from erroneous operation. Take appropriate measures for the warning light that comes on. (→P. 382)

The following table describes circumstances and correction procedures when only alarms are sounded.

Alarm	Situation	Correction procedure
Interior alarm pings once and exterior alarm sounds once for 5 seconds	An attempt was made to lock either door by opening a door and putting the inside lock button into the lock position, then closing the door by pulling on the outside door handle with the electronic key still inside the vehicle.	Retrieve the electronic key from the vehicle and lock the doors again.

Alarm	Situation	Correction procedure
Exterior alarm sounds once for 5 seconds	An attempt was made to lock the doors using the smart entry & start system while the electronic key was still inside the vehicle.	Retrieve the electronic key from the vehicle and lock the doors again.
	An attempt was made to lock the vehicle while a door was open.	Close all of the doors and lock the doors again.
Interior alarm sounds continuously	The “ENGINE START STOP” switch was turned to ACCESSORY mode while the driver’s door was open (or the driver’s door was opened while the “ENGINE START STOP” switch was in ACCESSORY mode).	Turn the “ENGINE START STOP” switch off and close the driver’s door.
Interior alarm sounds continuously*	The driver’s door was opened while any shift position other than P was selected without turning off the “ENGINE START STOP” switch.	Shift the shift lever to P.

*: Vehicles with an automatic transmission only

■ Security feature

If a door is not opened within approximately 30 seconds after the vehicle is unlocked, the security feature automatically locks the vehicle again. (However, depending on the location of the electronic key, the key may be detected as being in the vehicle. In this case, vehicle may be unlocked.)

■ Battery-saving function

The battery-saving function will be activated in order to prevent the electronic key battery and the vehicle battery from being discharged while the vehicle is not in operation for a long time.

- In the following situations, the smart entry & start system may take some time to unlock the doors.
 - The electronic key has been left in an area of approximately 2 m (6 ft.) of the outside of the vehicle for 10 minutes or longer.
 - The smart entry & start system has not been used for 5 days or longer.
- If the smart entry & start system has not been used for 14 days or longer, the doors cannot be unlocked at any doors except the driver's door. In this case, take hold of the driver's door handle, or use the wireless remote control or the mechanical key, to unlock the doors.

■ Conditions affecting operation

The smart entry & start system uses weak radio waves. In the following situations, the communication between the electronic key and the vehicle may be affected, preventing the smart entry & start system, wireless remote control and engine immobilizer system from operating properly.

(Way of coping →P. 416)

- When the electronic key battery is depleted
- Near a TV tower, electric power plant, gas station, radio station, large display, airport or other facility that generates strong radio waves or electrical noise
- When the electronic key is in contact with, or is covered by the following metallic objects
 - Cards to which aluminum foil is attached
 - Cigarette boxes that have aluminum foil inside
 - Metallic wallets or bags
 - Coins
 - Hand warmers made of metal
 - Media such as CDs and DVDs
- When other wireless key (that emit radio waves) is being used nearby
- When carrying the electronic key together with the following devices that emit radio waves
 - A portable radio, cellular phone, cordless phone or other wireless communication device
 - Another vehicle's electronic key or a wireless key that emits radio waves
 - Personal computers or personal digital assistants (PDAs)
 - Digital audio players
 - Portable game systems
- If window tint with a metallic content or metallic objects are attached to the rear window
- When the electronic key is placed near a battery charger or electronic devices

■ Notes for the entry function

- Even when the electronic key is within the effective range (detection areas), the system may not operate properly in the following cases:
 - The electronic key is too close to the window or outside door handle, near the ground, or in a high place when the doors are locked or unlocked.
 - The electronic key is near the ground or in a high place, or too close to the rear bumper center when the trunk is unlocked.
 - The electronic key is on the instrument panel, rear package tray or floor, in the door pockets or glove box or auxiliary box when the engine is started or “ENGINE START STOP” switch modes are changed.
- Do not leave the electronic key on top of the instrument panel or near the door pockets when exiting the vehicle. Depending on the radio wave reception conditions, it may be detected by the antenna outside the cabin and the door will become lockable from the outside, possibly trapping the electronic key inside the vehicle.
- As long as the electronic key is within the effective range, the doors may be locked or unlocked by anyone.
- Even if the electronic key is not inside the vehicle, it may be possible to start the engine if the electronic key is near the window.
- The doors may unlock if a large amount of water splashes on the door handle, such as in the rain or in a car wash when the electronic key is within the effective range. (The door will automatically be locked after approximately 30 seconds if the doors are not opened and closed.)
- Gripping the door handle when wearing a glove may not unlock the door.
- If the wireless remote control is used to lock the doors when the electronic key is near the vehicle, there is a possibility that the door may not be unlocked by the entry function. (Use the wireless remote control to unlock the doors.)
- A sudden approach to the effective range or door handle may prevent the doors from being unlocked. In this case, return the door handle to the original position and check that the doors unlock before pulling the door handle again.

■ Notes for locking the doors

- Touching the door lock sensor while wearing gloves may delay or prevent lock operation. Remove the gloves and touch the lock sensor again.
- Vehicles without a double locking system: When the lock operation is performed using the lock sensor, recognition signals will be shown up to two consecutive times. After this, no recognition signals will be given.
- If the door handle becomes wet when washing the vehicle while the electronic key is within the effective range, the door may lock and unlock repeatedly. In this case, place the electronic key in a location 2 m (6 ft.) or more away from the vehicle (take care to ensure that the key is not stolen), and continue to wash the vehicle.
- If the electronic key is inside the vehicle and a door handle becomes wet during a car wash, a buzzer will sound outside the vehicle. To turn off the alarm, lock all the doors.
- The lock sensor may not work properly if it comes into contact with ice, snow, mud, etc. Clean the lock sensor and attempt to operate it again.

■ Notes for the unlocking function

- A sudden approach to the effective range or door handle may prevent the doors from being unlocked. In this case, return the door handle to the original position and check that the doors unlock before pulling the door handle again.
- Gripping the door handle when wearing a glove may not unlock the door. Remove the gloves and touch the sensor on the back of the handle again.
- If the door handle becomes wet when washing the vehicle while the electronic key is within the effective range, the door may lock and unlock repeatedly. In this case, place the electronic key in a location 2 m (6 ft.) or more away from the vehicle (take care to ensure that the key is not stolen), and continue to wash the vehicle.
- If there is another electronic key in the detection area, it may take slightly longer to unlock the doors after the door handle is gripped.

■ When the vehicle is not driven for extended periods

- To prevent theft of the vehicle, do not leave the electronic key within 2 m (6 ft.) of the vehicle.
- The smart entry & start system can be deactivated in advance. (→P. 449)

■ To operate the system properly

- Make sure to carry the electronic key when operating the system. Do not get the electronic key too close to the vehicle when operating the system from the outside of the vehicle.

Depending on the position and holding condition of the electronic key, the key may not be detected correctly and the system may not operate properly. (The alarm may go off accidentally, or the door lock prevention function may not operate.)

- Do not leave the electronic key inside the trunk.

The key confinement prevention function may not operate, depending on the location of the key (close to a spare tire, the inside edge of the trunk), conditions (inside a metal bag, close to metallic objects) and the radio waves in the surrounding area. (→P. 60)

■ If the smart entry & start system does not operate properly

- Locking and unlocking the doors, unlocking the trunk: Use the mechanical key. (→P. 416)
- Starting the engine: →P. 417

■ **Electronic key battery depletion**

- The standard battery life is 1 to 2 years.
- If the battery becomes low, an alarm will sound in the cabin when the engine stops. (→P. 382)
- As the electronic key always receives radio waves, the battery will become depleted even if the electronic key is not used. The following symptoms indicate that the electronic key battery may be depleted. Replace the battery when necessary. (→P. 332)
 - The smart entry & start system or the wireless remote control does not operate.
 - The detection area becomes smaller.
 - The LED indicator on the key surface does not turn on.
- To avoid serious deterioration, do not leave the electronic key close to any of the following electrical appliances that produce a magnetic field:
 - TVs
 - Personal computers
 - Cellular phones, cordless phones and battery chargers
 - Recharging cellular phones or cordless phones
 - Induction cookers
 - Table lamps

■ **When the electronic key battery is fully depleted**

→P. 332

■ **If the smart entry & start system has been deactivated in a customized setting**

- Locking and unlocking the doors, unlocking the trunk: Use the wireless remote control or mechanical key. (→P. 51, 416)
- Starting the engine and changing “ENGINE START STOP” switch modes: →P. 417
- Stopping the engine: →P. 419

■ **Customization that can be configured at any authorized Toyota dealer or repairer, or another duly qualified and equipped professional**

Settings (e. g. smart entry & start system) can be changed.
(Customizable features: →P. 449)

■ Certification for smart entry & start system



FUJI HEAVY INDUSTRIES LTD.
SUBARU ENGINEERING DIVISION
1-1 SUBARU-CHO OTA GUNMA 373-8555 JAPAN
Phone: +81 276-26-2381 Fax: +81 276-26-2397

1

Before driving

R&TTE Declaration of Conformity

We,

Manufacturer's Name: Fuji Heavy Industries Ltd.
Manufacturer's Address: 1-7-2, Nishishinjuku, Shinjuku, Tokyo, 160-8316 Japan

hereby declare under our sole responsibility that the product:

Product Name: LF Oscillator
Product Model: SSPLF03

to which this declaration relates is in conformity with the essential requirements and other relevant requirements of the R&TTE Directive (1999/5/EC). The product is compliant with the following standards and/or other normative documents:

-Health & safety requirements: EN60950-1
-EMC requirements: EN301 489-1 & EN301 489-3
-Effective uses of radio spectrum: EN300 330-2

Supplementary information:

* CE mark	
* Member states intended for use	EU and EFTA

Date: February 14, 2011

Signature: Takashi Nishida
Takashi Nishida

1-2. Opening, closing and locking the doors and trunk

Hereby, Fuji Heavy Industries Ltd., declares that this SSPLF03 is in compliance with the essential requirements and other relevant provisions of Directive 1999/5/EC.

Fuji Heavy Industries Ltd. vakuuttaa täten että SSPLF03 tyyppinen laite on direktiivin 1999/5/EY oleellisten vaatimusten ja sitä koskevien direktiivin muiden ehtojen mukainen.

Hierbij verklaart Fuji Heavy Industries Ltd. dat het toestel SSPLF03 in overeenstemming is met de essentiële eisen en de andere relevante bepalingen van richtlijn 1999/5/EG.

Par la présente Fuji Heavy Industries Ltd. déclare que l'appareil SSPLF03 est conforme aux exigences essentielles et aux autres dispositions pertinentes de la directive 1999/5/CE.

Härmed intygar Fuji Heavy Industries Ltd. att denna SSPLF03 står i överensstämmelse med de väsentliga egenskapskrav och övriga relevanta bestämmelser som framgår av direktiv 1999/5/EG.

Undertegnede Fuji Heavy Industries Ltd. erklærer herved, at følgende udstyr SSPLF03 overholder de væsentlige krav og øvrige relevante krav i direktiv 1999/5/EF.

Hiermit erklärt Fuji Heavy Industries Ltd., dass sich das Gerät SSPLF03 in Übereinstimmung mit den grundlegenden Anforderungen und den übrigen einschlägigen Bestimmungen der Richtlinie 1999/5/EG befindet.

ΜΕ ΤΗΝ ΠΑΡΟΥΣΑ Fuji Heavy Industries Ltd. ΔΗΛΩΝΕΙ ΟΤΙ SSPLF03 ΣΥΜΜΟΡΦΩΝΕΤΑΙ ΠΡΟΣ ΤΙΣ ΟΥΣΙΩΔΕΙΣ ΑΠΑΙΤΗΣΕΙΣ ΚΑΙ ΤΙΣ ΛΟΙΠΕΣ ΣΧΕΤΙΚΕΣ ΔΙΑΤΑΞΕΙΣ ΤΗΣ ΟΔΗΓΙΑΣ 1999/5/ΕΚ.

Con la presente Fuji Heavy Industries Ltd. dichiara che questo SSPLF03 è conforme ai requisiti essenziali ed alle altre disposizioni pertinenti stabilite dalla direttiva 1999/5/CE.

Por medio de la presente Fuji Heavy Industries Ltd. declara que el SSPLF03 cumple con los requisitos esenciales y cualesquiera otras disposiciones aplicables o exigibles de la Directiva 1999/5/CE.

Fuji Heavy Industries Ltd. declara que este SSPLF03 está conforme com os requisitos essenciais e outras disposições da Directiva 1999/5/CE.

Hawnekk, Fuji Heavy Industries Ltd., jiddikjara li dan SSPLF03 jikkonforma mal-htigijiet essenzjali u ma provvedimenti oħrajn relevanti li hemm fid-Direttiva 1999/5/EC.

Käesolevaga kinnitab Fuji Heavy Industries Ltd. seadme SSPLF03 vastavust direktiivi 1999/5/EÜ põhinõuetele ja nimetatud direktiivist tulenevatele teistele asjakohastele sätetele.

Alulirott, Fuji Heavy Industries Ltd. nyilatkozom, hogy a SSPLF03 megfelel a vonatkozó alapvető követelményeknek és az 1999/5/EC irányelv egyéb előírásainak.

Fuji Heavy Industries Ltd. týmto vyhlasuje, že SSPLF03 spĺňa základné požiadavky a všetky príslušné ustanovenia Smernice 1999/5/ES.

Fuji Heavy Industries Ltd. tímto prohlašuje, že tento SSPLF03 je ve shodě se základními požadavky a dalšími příslušnými ustanoveními směrnice 1999/5/ES.

Fuji Heavy Industries Ltd. izjavlja, da je ta SSPLF03 v skladu z bistvenimi zahtevami in ostalimi relevantnimi določili direktive 1999/5/ES.

Šiuo Fuji Heavy Industries Ltd. deklaruoja, kad šis SSPLF03 atitinka esminius reikalavimus ir kitas 1999/5/EB Direktyvos nuostatas.

Ar šo Fuji Heavy Industries Ltd. deklarē, ka SSPLF03 atbilst Direktīvas 1999/5/EK būtiskajām prasībām un citiem ar to saistītajiem noteikumiem.

Niniejszym Fuji Heavy Industries Ltd. oświadcza, że SSPLF03 jest zgodny z zasadniczymi wymogami oraz pozostałymi stosownymi postanowieniami Dyrektywy 1999/5/EC.

Hér með lýsir Fuji Heavy Industries Ltd. yfir því að SSPLF03 er í samræmi við grunnkröfur og aðrar kröfur, sem gerðar eru í tilskipun 1999/5/EC.

Fuji Heavy Industries Ltd. erklærer herved at udstyret SSPLF03 er i samsvar med de grundlæggende krav og øvrige relevante krav i direktiv 1999/5/EF.

1-2. Opening, closing and locking the doors and trunk

С настоящето, Fuji Heavy Industries Ltd., декларира, че SSPLF03 е в съответствие със съществените изисквания и другите приложими разпоредби на Директива 1999/5/EC.

Prin prezenta, Fuji Heavy Industries Ltd., declară că aparatul SSPLF03 este în conformitate cu cerințele esențiale și cu alte prevederi pertinente ale Directivei 1999/5/CE.

Ovim, Fuji Heavy Industries Ltd., izjavljuje da ovaj SSPLF03 je usklađen sa bitnim zahtjevima i drugim relevantnim odredbama Direktive 1999/5/EC.

Ovim Fuji Heavy Industries Ltd., izjavljuje da je SSPLF03 u skladu s bitnim zahtjevima i drugim relevantnim odredbama Direktive 1999/5/EC i Pravilnika o RiTT opremi (NN 25/2012).

Ovim, Fuji Heavy Industries Ltd., deklariše da je SSPLF03 u skladu sa osnovnim zahtevima i ostalim relevantnim odredbama Direktive 1999/5/EC.

-Replace only with the same or equivalent type recommended by the manufacturer.

-Dispose of used batteries according to the local laws.



The latest "DECLARATION of CONFORMITY" (DoC) is available at the following address:
<http://www.globaldenso.com/en/products/oem/index.html>

Hereby, DENSO CORPORATION declares that this 13CZY/14AER is in compliance with the essential requirements and other relevant provisions of Directive 1999/5/EC.

DENSO CORPORATION vakuuttaa täten että 13CZY/14AER tyyppinen laite on direktiivin 1999/5/EY oleellisten vaatimusten ja sitä koskevien direktiivin muiden ehtojen mukainen.

Hierbij verklaart DENSO CORPORATION dat het toestel 13CZY/14AER in overeenstemming is met de essentiële eisen en de andere relevante bepalingen van richtlijn 1999/5/EG.

Par la présente DENSO CORPORATION déclare que l'appareil 13CZY/14AER est conforme aux exigences essentielles et aux autres dispositions pertinentes de la directive 1999/5/CE.

Härmed intygar DENSO CORPORATION att denna 13CZY/14AER står i överensstämmelse med de väsentliga egenskapskrav och övriga relevanta bestämmelser som framgår av direktiv 1999/5/EG.

Undertegnede DENSO CORPORATION erklærer herved, at følgende udstyr 13CZY/14AER overholder de væsentlige krav og øvrige relevante krav i direktiv 1999/5/EF.

Hiermit erkläre DENSO CORPORATION, dass sich das Gerät 13CZY/14AER in Übereinstimmung mit den grundlegenden Anforderungen und den übrigen einschlägigen Bestimmungen der Richtlinie 1999/5/EG befindet.

ΜΕ ΤΗΝ ΠΑΡΟΥΣΑ DENSO CORPORATION ΔΗΛΩΝΕΙ ΟΤΙ 13CZY/14AER ΣΥΜΜΟΡΦΩΝΕΤΑΙ ΠΡΟΣ ΤΙΣ ΟΥΣΙΩΔΕΙΣ ΑΠΑΙΤΗΣΕΙΣ ΚΑΙ ΤΙΣ ΛΟΙΠΕΣ ΣΧΕΤΙΚΕΣ ΔΙΑΤΑΞΕΙΣ ΤΗΣ ΩΔΗΓΙΑΣ 1999/5/ΕΚ.

Con la presente DENSO CORPORATION dichiara che questo 13CZY/14AER è conforme ai requisiti essenziali ed alle altre disposizioni pertinenti stabilite dalla direttiva 1999/5/CE.

Por medio de la presente DENSO CORPORATION declara que el 13CZY/14AER cumple con los requisitos esenciales y cualesquiera otras disposiciones aplicables o exigibles de la Directiva 1999/5/CE.

DENSO CORPORATION declara que este 13CZY/14AER está conforme com os requisitos essenciais e outras disposições da Directiva 1999/5/CE.

Hawnhekk, DENSO CORPORATION, jiddikjara li dan 13CZY/14AER jikkonforma mal-htigijiet essenzjali u ma provvedimenti oħrajn rilevanti li hemm fid-Direttiva 1999/5/EC.

Käesolevaga kinnitab DENSO CORPORATION seadme 13CZY/14AER vastavust direktiivi 1999/5/EÜ põhinõuetele ja nimetatud direktiivi tulenevatele teistele asjakohastele sätetele.

Alulirott, DENSO CORPORATION nyilatkozom, hogy a 13CZY/14AER megfelel a vonatkozó alapvető követelményeknek és az 1999/5/EC irányelv egyéb előírásainak.

DENSO CORPORATION týmto vyhlasuje, že 13CZY/14AER splňa základné požiadavky a všetky príslušné ustanovenia Smernice 1999/5/ES.

DENSO CORPORATION tímto prohlašuje, že tento 13CZY/14AER je ve shodě se základními požadavky a dalšími příslušnými ustanoveními směrnice 1999/5/ES.

DENSO CORPORATION izjavlja, da je ta 13CZY/14AER v skladu z bistvenimi zahtevami in ostalimi relevantnimi določili direktive 1999/5/ES.

Šiuo DENSO CORPORATION deklaruoja, kad šis 13CZY/14AER atitinka esminius reikalavimus ir kitas 1999/5/EB Direktyvos nuostatas.

Ar šo DENSO CORPORATION deklarē, ka 13CZY/14AER atbilst Direktīvas 1999/5/EK būtiskajām prasībām un citiem ar to saistītajiem noteikumiem.

Niniejszym DENSO CORPORATION oświadczca, że 13CZY/14AER jest zgodny z zasadniczymi wymogami oraz pozostający stosownymi postanowieniami Dyrektywy 1999/5/EC.

Hér með lýsir DENSO CORPORATION yfir því að 13CZY/14AER er í samræmi við grunnkröfur og aðrar kröfur, sem gerðar eru í tilskipun 1999/5/EC.

DENSO CORPORATION erklærer herved at utstyret 13CZY/14AER er i samsvar med de grunnleggende krav og øvrige relevante krav i direktiv 1999/5/EF.

С настоящего, DENSO CORPORATION, декларира, че 13CZY/14AER е в съответствие със съществениите изисквания и другите приложими разпоредби на Директива 1999/5/EC.

Prin prezenta, DENSO CORPORATION, declară că aparatul 13CZY/14AER este în conformitate cu cerințele esențiale și cu alte prevederi pertinente ale Directivei 1999/5/CE.

Ovim, DENSO CORPORATION, izjavljuje da ovaj 13CZY/14AER je usklađen sa bitnim zahtjevima i drugim relevantnim odredbama Direktive 1999/5/EC.

Ovim, DENSO CORPORATION, deklarirše da je 13CZY/14AER u skladu sa osnovnim zahtevima i ostalim relevantnim odredbama Direktive 1999/5/EC.

Ovim DENSO CORPORATION, izjavljuje da je 13CZY/14AER u skladu sa bitnim zahtjevima i drugim relevantnim odredbama Direktive 1999/5/EC i Pravilnika o RiTT opremi (NN 25/2012).

 CAUTION

■ **Caution regarding interference with electronic devices**

- People with implantable cardiac pacemakers, cardiac resynchronization therapy-pacemakers or implantable cardioverter defibrillators should maintain a reasonable distance between themselves and the smart entry & start system antennas. (→P. 35)

The radio waves may affect the operation of such devices. If necessary, the entry function can be disabled. Ask any authorized Toyota dealer or repairer, or another duly qualified and equipped professional for details, such as the frequency of radio waves and timing of the emitted radio waves. Then, consult your doctor to see if you should disable the entry function.

- User of any electrical medical device other than implantable cardiac pacemakers, cardiac resynchronization therapy-pacemakers or implantable cardioverter defibrillators should consult the manufacturer of the device for information about its operation under the influence of radio waves.

Radio waves could have unexpected effects on the operation of such medical devices.

Ask any authorized Toyota dealer or repairer, or another duly qualified and equipped professional for details for disabling the entry function.

1-2. Opening, closing and locking the doors and trunk Wireless remote control

The wireless remote control can be used to lock and unlock the vehicle.

Vehicles without a smart entry & start system

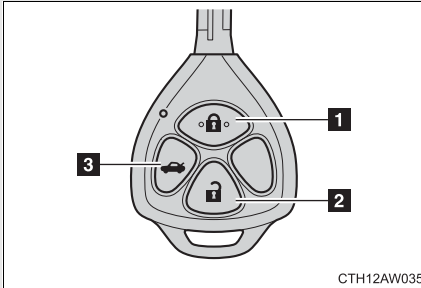

1 Locks both side doors^{*1}

Check that the door is securely locked.

Locks driver's door^{*2}

Check that the door is securely locked.

2 Unlocks both side doors^{*1}

Pressing the button unlocks the driver's door. Pressing the button again within 3 seconds unlocks the other doors.

Unlocks both side door^{*2}

3 Unlocks the trunk (press and hold)

Vehicles with a smart entry & start system

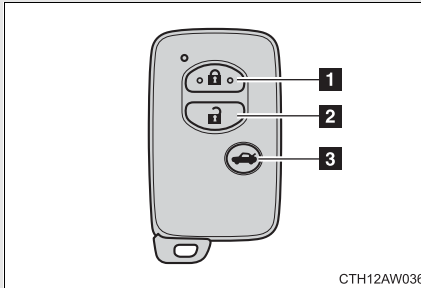

1 Locks both side doors ^{*1}

Check that the door is securely locked.

Locks driver's door ^{*2}

Check that the door is securely locked.

2 Unlocks both side doors ^{*1}

Pressing the button unlocks the driver's door. Pressing the button again within 3 seconds unlocks the other doors.

Unlocks both side door ^{*2}

3 Unlocks the trunk (press and hold)

*1: Vehicles with a double locking system

*2: Vehicles without a double locking system

■ Operation signals

The emergency flashers flash to indicate that the doors have been locked/unlocked. (Locked: Once; Unlocked: Twice)

■ Door lock buzzer (vehicles with a smart entry & start system)

If an attempt to lock the doors is made when a door is not fully closed, a buzzer sounds continuously. Fully close the door to stop the buzzer, and lock the vehicle once more.

■ Security feature

If a door is not opened within approximately 30 seconds after the vehicle is unlocked, the security feature automatically locks the vehicle again.

■ Conditions affecting operation

Vehicles without a smart entry & start system

The wireless remote control function may not operate normally in the following situations:

- When the wireless key battery is depleted
- Near a TV tower, electric power plant, gas station, radio station, large display, airport or other facility that generates strong radio waves or electrical noise
- When carrying a portable radio, cellular phone or other wireless communication devices
- When the wireless key is in contact with, or is covered by a metallic object
- When other wireless key (that emit radio waves) is being used nearby
- If window tint with a metallic content or metallic objects are attached to the rear window

Vehicles with a smart entry & start system

→P. 40

■ **If the wireless remote control does not operate properly (vehicles with a smart entry & start system)**

Locking and unlocking the doors, unlocking the trunk: Use the mechanical key. (→P. 416)

■ **Key battery depletion**

Vehicles without a smart entry & start system

If the wireless remote control function does not operate, the battery may be depleted. Replace the battery when necessary. (→P. 332)

Vehicles with a smart entry & start system

→P. 44

■ **When the electronic key battery is fully depleted**

→P. 332

■ **Confirmation of the registered key number (vehicles with a smart entry & start system)**

The number of keys already registered to the vehicle can be confirmed. Ask any authorized Toyota dealer or repairer, or another duly qualified and equipped professional for details.

■ **Customization that can be configured at any authorized Toyota dealer or repairer, or another duly qualified and equipped professional**

Settings (e.g. wireless remote control system) can be changed.
(Customizable features →P. 449)

■ Certification for wireless remote control

- Replace only with the same or equivalent type recommended by the manufacturer.
- Dispose of used batteries according to the local laws.



The latest "DECLARATION of CONFORMITY" (DoC) is available at the following address:
<http://www.globaldenso.com/en/products/oem/index.html>

Hereby, DENSO CORPORATION declares that this 13BDD/12BBY is in compliance with the essential requirements and other relevant provisions of Directive 1999/5/EC.

DENSO CORPORATION vakuuttaa täten että 13BDD/12BBY tyyppinen laite on direktiivin 1999/5/EY oleellisten vaatimusten ja sitä koskevien direktiivin muiden ehtojen mukainen.

Hierbij verklaart DENSO CORPORATION dat het toestel 13BDD/12BBY in overeenstemming is met de essentiële eisen en de andere relevante bepalingen van richtlijn 1999/5/EG.

Par la présente DENSO CORPORATION déclare que l'appareil 13BDD/12BBY est conforme aux exigences essentielles et aux autres dispositions pertinentes de la directive 1999/5/CE.

Härmed intygar DENSO CORPORATION att denna 13BDD/12BBY står i överensstämmelse med de väsentliga egenskapskrav och övriga relevanta bestämmelser som framgår av direktiv 1999/5/EG.

Undertegnede DENSO CORPORATION erklærer herved, at følgende udstyr 13BDD/12BBY overholder de væsentlige krav og øvrige relevante krav i direktiv 1999/5/EF.

Hiermit erklärt DENSO CORPORATION, dass sich das Gerät 13BDD/12BBY in Übereinstimmung mit den grundlegenden Anforderungen und den übrigen einschlägigen Bestimmungen der Richtlinie 1999/5/EG befindet.

ΜΕ ΤΗΝ ΠΑΡΟΥΣΑ DENSO CORPORATION ΔΗΛΩΝΕΙ ΟΤΙ 13BDD/12BBY ΣΥΜΜΟΡΦΩΝΕΤΑΙ ΠΡΟΣ ΤΙΣ ΟΥΣΙΩΔΕΙΣ ΑΠΑΙΤΗΣΕΙΣ ΚΑΙ ΤΙΣ ΛΟΙΠΕΣ ΣΧΕΤΙΚΕΣ ΔΙΑΤΑΞΕΙΣ ΤΗΣ ΟΔΗΓΙΑΣ 1999/5/ΕΚ.

Con la presente DENSO CORPORATION dichiara che questo 13BDD/12BBY è conforme ai requisiti essenziali ed alle altre disposizioni pertinenti stabilite dalla direttiva 1999/5/CE.

Por medio de la presente DENSO CORPORATION declara que el 13BDD/12BBY cumple con los requisitos esenciales y cualesquiera otras disposiciones aplicables o exigibles de la Directiva 1999/5/CE.

DENSO CORPORATION declara que este 13BDD/12BBY está conforme com os requisitos essenciais e outras disposições da Directiva 1999/5/CE.

Hawnhekk, DENSO CORPORATION, jiddikjara li dan 13BDD/12BBY jikkonforma mal-htigijiet essenzjali u ma provvedimenti oħrajn relevanti li hemm fid-Direttiva 1999/5/EC.

Käesolevaga kinnitab DENSO CORPORATION seadme 13BDD/12BBY vastavust direktiivi 1999/5/EÜ põhinõuetele ja nimetatud direktiivist tulenevatele teistele asjakohastele sätetele.

Alulirott, DENSO CORPORATION nyilatkozom, hogy a 13BDD/12BBY megfelel a vonatkozó alapvető követelményeknek és az 1999/5/EC irányelv egyéb előírásainak.

DENSO CORPORATION týmto vyhlasuje, že 13BDD/12BBY spĺňa základné požiadavky a všetky príslušné ustanovenia Smernice 1999/5/ES.

DENSO CORPORATION tímto prohlašuje, že tento 13BDD/12BBY je ve shodě se základními požadavky a dalšími příslušnými ustanoveními směrnice 1999/5/ES.

DENSO CORPORATION izjavlja, da je ta 13BDD/12BBY v skladu z bistvenimi zahtevami in ostalimi relevantnimi določili direktive 1999/5/ES.

Šiuo DENSO CORPORATION deklaruoja, kad šis 13BDD/12BBY atitinka esminius reikalavimus ir kitas 1999/5/EB Direktyvos nuostatas.

Ar šo DENSO CORPORATION deklarē, ka 13BDD/12BBY atbilst Direktīvas 1999/5/EK būtiskajām prasībām un citiem ar to saistītajiem noteikumiem.

Niniejszym DENSO CORPORATION oświadcza, że 13BDD/12BBY jest zgodny z zasadniczymi wymogami oraz pozostałymi stosownymi postanowieniami Dyrektywy 1999/5/EC.

Hér með lýsir DENSO CORPORATION yfir því að 13BDD/12BBY er í samræmi við grunnkröfur og aðrar kröfur, sem gerðar eru í tilskipun 1999/5/EC.

DENSO CORPORATION erklærer herved at udstyret 13BDD/12BBY er i samsvar med de grunnleggende krav og øvrige relevante krav i direktiv 1999/5/EF.

С настоящето, DENSO CORPORATION, декларира, че 13BDD/12BBY е в съответствие със съществените изисквания и другите приложими разпоредби на Директива 1999/5/EC.

Prin prezenta, DENSO CORPORATION, declară că aparatul 13BDD/12BBY este în conformitate cu cerințele esențiale și cu alte prevederi pertinente ale Directivei 1999/5/CE.

Ovim, DENSO CORPORATION, izjavljuje da ovaj 13BDD/12BBY je uskladen sa bitnim zahtjevima i drugim relevantnim odredbama Direktive 1999/5/EC.

Ovim, DENSO CORPORATION, deklarirše da je 13BDD/12BBY u skladu sa osnovnim zahtevima i ostalim relevantnim odredbama Direktive 1999/5/EC.

Ovim DENSO CORPORATION, izjavljuje da je 13BDD/12BBY u skladu sa bitnim zahtjevima i drugim relevantnim odredbama Direktive 1999/5/EC i Pravilnika o RIT opremi (NN 25/2012).

1-2. Opening, closing and locking the doors and trunk Doors

The vehicle can be locked and unlocked using the entry function, wireless remote control, key or door lock switch.

■ Entry function (vehicles with a smart entry & start system)

→P. 34

■ Wireless remote control

→P. 51

■ Key

Turning the key operates the doors as follows:

Vehicles without a smart entry & start system

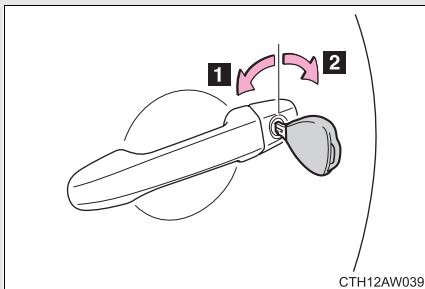

1 Locks both side doors^{*1}
Locks driver's door^{*2}

2 Unlocks both side doors^{*1}

Turning the key unlocks the driver's door. Turning the key again unlocks the other doors.

Unlocks driver's door^{*2}

^{*1}: Vehicles with a double locking system

^{*2}: Vehicles without a double locking system

Vehicles with a smart entry & start system

The doors can also be locked and unlocked with the mechanical key. (→P. 416)

■ Door lock switch

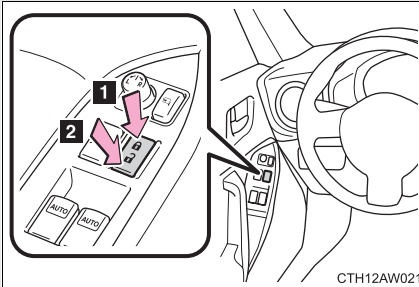

- 1 Locks both side doors
- 2 Unlocks both side doors

■ Inside lock button

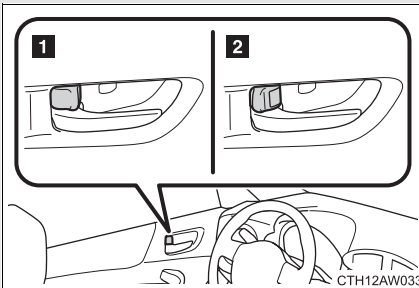

- 1 Locks the door
- 2 Unlocks the door

Locking the doors from the outside without a key

STEP 1 Move the inside lock button to the lock position.

STEP 2 Close the door while pulling the door handle.

Vehicles with a smart entry & start system

The door cannot be locked if the “ENGINE START STOP” switch is in ACCESSORY or IGNITION ON mode, or the electronic key is left inside the vehicle.

The key may not be detected correctly and the door may be locked.

■ **Window open/close function linked to door operation**

In order to make opening and closing the doors easier, completely closed windows are linked to door operations. Therefore, when a door is opened, its window opens slightly. When a door is closed, its window closes completely.

However, if the battery has discharged or is disconnected, this function will not operate. (→P. 424)

■ **If a wrong key is used (vehicles with a double locking system)**

The key cylinder rotates freely to isolate inside mechanism.

■ **If the smart entry & start system has been deactivated in a customized setting (vehicles with a smart entry & start system)**

Use the wireless remote control or mechanical key. (→P. 51, 416)



CAUTION

■ **To prevent an accident**

Observe the following precautions while driving the vehicle.

Failure to do so may result in a door opening and an occupant falling out, resulting in death or serious injury.

● Always use a seat belt.

● Ensure that both side doors are properly closed.

● Do not pull the inside handle of the doors while driving.

The doors may be opened and the passengers are thrown out of the vehicle and it may result in serious injury or death.

1-2. Opening, closing and locking the doors and trunk

Trunk

The trunk can be opened using the key, trunk opener, entry function or wireless remote control.

■ Opening the trunk from inside the vehicle

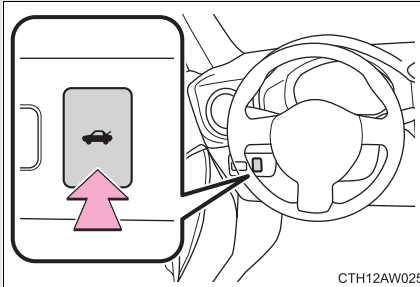

Press and hold the opener switch to release the trunk lid.

■ Opening the trunk from outside the vehicle

Key (vehicles without a smart entry & start system and the double locking system)

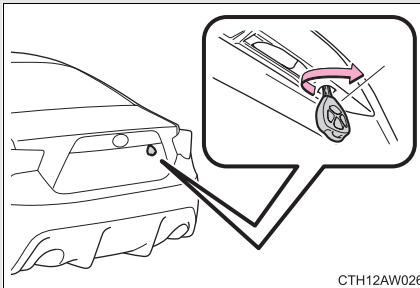

Turn the master key clockwise to release the trunk lid.

Entry function (vehicles with a smart entry & start system)

→P. 35

Wireless remote control

→P. 51

■ **Trunk light**

The trunk light turns on when the trunk is opened.

■ **Function to prevent the trunk being locked with the electronic key inside (vehicles with a smart entry & start system)**

● When all doors are being locked, closing the trunk lid with the electronic key left inside the trunk will sound an alarm.

In this case, the trunk lid can be opened using the entry function.

● Even when the spare electronic key is put in the trunk with all the doors locked, the key confinement prevention function can be activated so the trunk can be opened. In order to prevent theft, take all electronic keys with you when leaving the vehicle.

● Even when the electronic key is put in the trunk with all the doors are locked, the key may not be detected depending on the places and the surrounding radio wave conditions. In this case, the key confinement prevention function cannot be activated, causing the doors to lock when the trunk is closed. Make sure to check where the key is before closing the trunk.

● The key confinement prevention function cannot be activated if any one of the doors is unlocked. In this case, open the trunk using the trunk opener.

■ **Using the mechanical key (vehicles with a smart entry & start system but without the double locking system)**

The trunk can be also opened using the mechanical key. (→P. 416)

 **CAUTION****■ Caution while driving**

- Keep the trunk lid closed while driving.

If the trunk lid is left open, it may hit near-by objects while driving or luggage in the trunk may be unexpectedly thrown out, causing an accident. In addition, exhaust gases may enter the vehicle, causing death or a serious health hazard. Make sure to close the trunk lid before driving.

- Before driving the vehicle, make sure that the trunk lid is fully closed. If the trunk lid is not fully closed, it may open unexpectedly while driving, causing an accident.
- Never let anyone sit in the trunk. In the event of sudden braking or a collision, they are susceptible to death or serious injury.

■ When children are in the vehicle

Observe the following precautions.

Failure to do so may result in death or serious injury.

- Do not allow children to play in the trunk.

If a child is accidentally locked in the trunk, they could suffer from heat exhaustion, suffocation or other injuries.

- Do not allow a child to open or close the trunk lid.

Doing so may cause the trunk lid to operate unexpectedly, or cause the child's hands, head, or neck to be caught by the closing trunk lid.

⚠ CAUTION

■ Using the trunk

Observe the following precautions.

Failure to do so may cause parts of the body to be caught, resulting in serious injury.

- Remove any heavy loads, such as snow and ice, from the trunk lid before opening it. Failure to do so may cause the trunk lid to suddenly shut again after it is opened.
- When opening or closing the trunk lid, thoroughly check to make sure the surrounding area is safe.
- If anyone is in the vicinity, make sure they are safe and let them know that the trunk is about to open or close.
- Use caution when opening or closing the trunk lid in windy weather as it may move abruptly in strong wind.

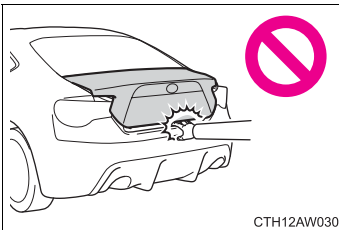
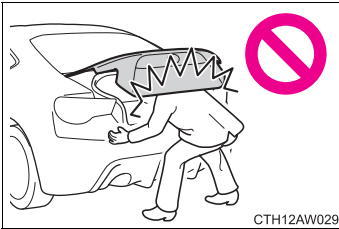

- The trunk lid may suddenly shut if it is not opened fully. It is more difficult to open or close the trunk lid on an incline than on a level surface, so beware of the trunk lid unexpectedly opening or closing by itself. Make sure that the trunk lid is fully open and secure before using the trunk.
- When closing the trunk lid, take extra care to prevent your fingers etc. from being caught.
- When closing the trunk lid, make sure to press it lightly on its outer surface.

- Do not attach any accessories other than genuine Toyota parts to the trunk lid. Such additional weight on the trunk lid may cause the lid to suddenly shut again after it is opened.

**NOTICE****Trunk damper stays**

The trunk lid is equipped with damper stays that hold the trunk lid in place. Observe the following precautions.

Failure to do so may cause damage to trunk damper stays, resulting in a malfunction.

- Do not attach any foreign objects such as stickers, plastic sheets and adhesives to damper stay rods.
- Do not touch damper stay rods with gloves or other fabric items.
- Do not attach any accessories other than genuine Toyota parts to the trunk lid.
- Do not apply lateral force to damper stays or place your hand on it.

1-3. Adjustable components (seats, mirrors, steering wheel)

Front seats

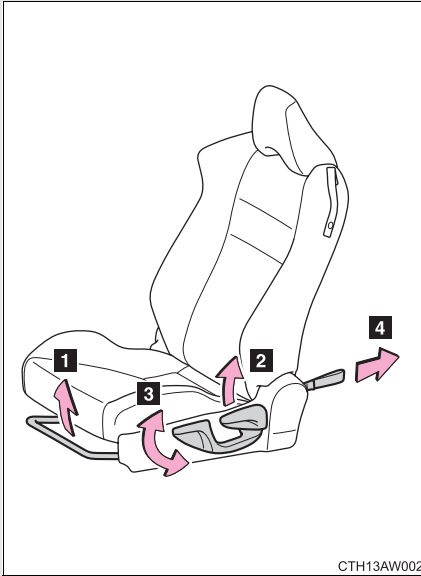

CTH13AW002

- 1** Seat position adjustment lever
- 2** Seatback angle adjustment lever
- 3** Vertical height adjustment lever (driver's side only)
- 4** Seatback fold strap (if equipped)

Getting in and out of the rear seats

To get in and out of the rear seats, use the seatback angle adjustment lever or seatback fold strap.

■ Before getting in or out of the rear seats

Release the seat belt from the seat belt guide. (→P. 73)

■ Getting in the rear seats

Driver's side (if equipped)

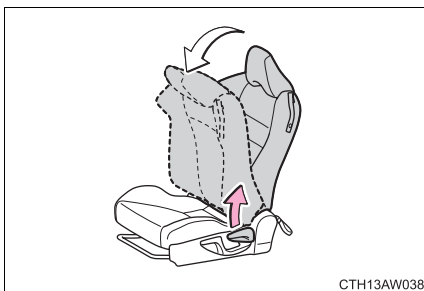

Lift the seatback angle adjustment lever.

The seatback will fold forward.

Passenger's side

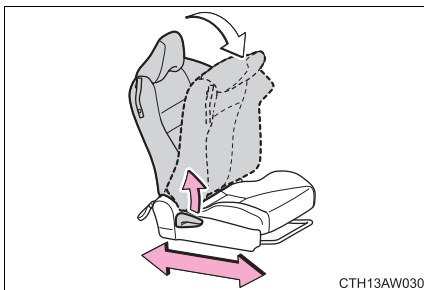

Lift the seatback angle adjustment lever.

The seatback will fold forward.

The seat can be slid forward and backward.

■ Getting out of the rear seats

Driver's side (if equipped)

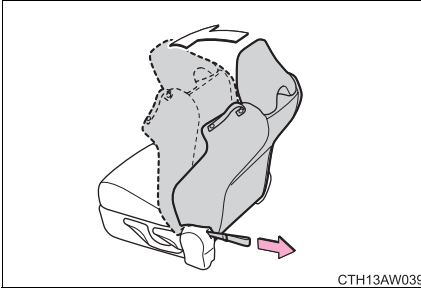

Pull the seatback fold strap.

The seatback will fold forward.

Passenger's side

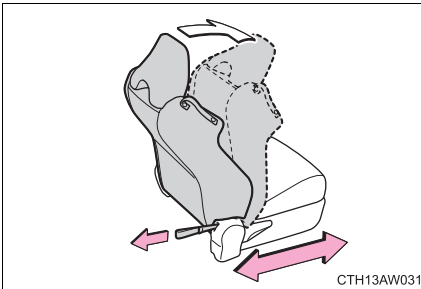

Pull the seatback fold strap.

The seatback will fold forward.

The seat can be slid forward and backward.

■ After getting in or out of the rear seats

Return the seatback to the upright position until the seat locks.

Front passenger seat only: The seat will lock in position at the point where the seatback reaches the upright position.

■ Seat dust cover

Always remove the seat dust cover that may be attached at the time of purchase before using the seat.

⚠ CAUTION**■ Seat adjustment**

- To reduce the risk of sliding under the lap belt during a collision, do not recline the seat more than necessary.

If the seat is too reclined, the lap belt may slide past the hips and apply restraint forces directly to the abdomen, or your neck may contact the shoulder belt, increasing the risk of death or serious injury in the event of an accident.

Adjustments should not be made while driving as the seat may unexpectedly move and cause the driver to lose control of the vehicle.

- After adjusting the seat, make sure that the seat is locked in position.
- Take care not to hit passengers with the seat.
When sliding the seat rearward, make sure not to squash the legs of the rear passengers.
- When returning the seatback upright, perform seatback angle adjustment while holding down the seatback.
- Do not pull on or use the front seat belt guide to adjust or fold the front seat.
- Do not put your hands under the seat or near the moving parts to avoid injury. Fingers or hands may become jammed in the seat mechanism.

■ When driving the vehicle

Never operate the seatback angle adjustment lever or seatback fold strap. Doing so could cause an accident resulting in death or serious injury.

■ Getting in and out of the rear seats

- When getting in or out of the rear seats, make sure not to get your hands, legs, etc. squashed in the movable or connecting parts.
- When getting in or out of the rear seats, make sure not to trip on the seat rails.
- After getting in or out of the rear seats, always make sure the front seat is locked in position.

■ When operating the front seat from the rear seat

Make sure that no passenger is seated in the front seat.

1-3. Adjustable components (seats, mirrors, steering wheel)

Rear seats

The seatbacks of the rear seats can be folded down.

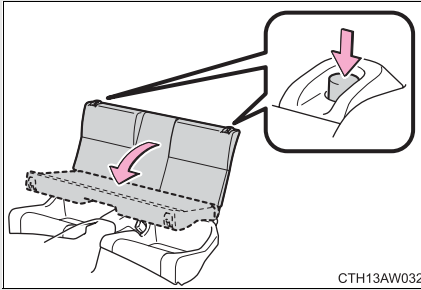

Press the seatback lock release buttons and fold the seatback down.

Press the button until the lock is released.

To return the seatbacks to its original position, lift it up until it locks.

■ Seat dust cover

Always remove the seat dust cover that may be attached at the time of purchase before using the seat.

⚠ CAUTION

■ When folding the rear seatbacks down

Observe the following precautions. Failure to do so may result in death or serious injury.

- Do not fold the seatbacks down while driving.
- Stop the vehicle on level ground, set the parking brake and shift the shift lever to P (automatic transmission) or N (manual transmission).
- Do not allow anyone to sit on a folded seatback or in the trunk while driving.
- Do not allow children to enter the trunk.

⚠ CAUTION**■ After returning the rear seatback to the upright position**

Observe the following precautions. Failure to do so may result in death or serious injury.

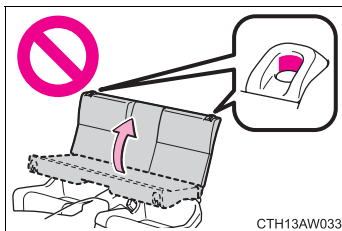

- Make sure that the seatback is securely locked in position by lightly pushing it back and forth. If the seatback is not securely locked, the red portion behind the seatback lock release button will be visible. Make sure that the red portion is not visible.

- Check that the seat belts are not twisted or caught in the seatback.

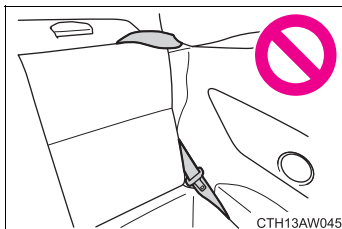
■ Before using the rear seat belts

Always make sure that the seat belt is not caught in the seatback or twisted in one of the hooks that secure the seatback. Failure to do so may cause the seat belt to not be fastened correctly or to become ineffective in a collision, resulting in death or serious injury.

1-3. Adjustable components (seats, mirrors, steering wheel)

Head restraints

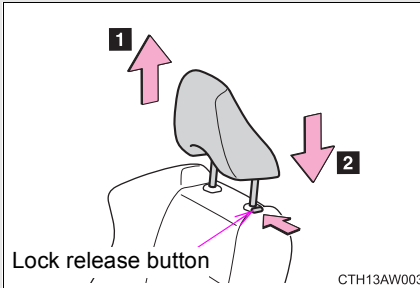

1 Up

Pull the head restraints up.

2 Down

Push the head restraint down while pushing the lock release button.

■ Removing the head restraints

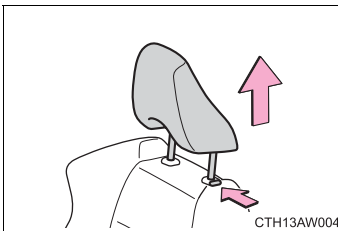

Pull the head restraint up while pushing the lock release button.

■ Installing the head restraints

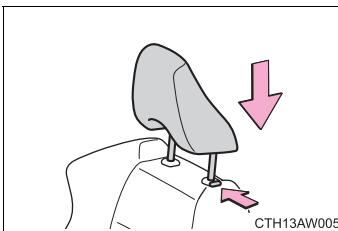

Align the head restraint with the installation holes and push it down to the lock position.

Press and hold the lock release button when lowering the head restraint.

■ Adjusting the height of the head restraints

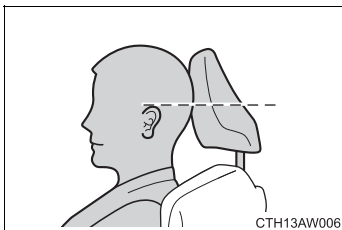

Make sure that the head restraints are adjusted so that the center of the head restraint is closest to the top of your ears.

⚠ CAUTION

■ Head restraint precautions

Observe the following precautions regarding the head restraints. Failure to do so may result in death or serious injury.

- Use head restraints designed for each respective seat.
- Adjust the head restraints to the correct position at all times.
- After adjusting the head restraints, push down on them and make sure they are locked in position.
- Do not drive with the head restraints removed.

1-3. Adjustable components (seats, mirrors, steering wheel)

Seat belts

Make sure that all occupants are wearing their seat belts before driving the vehicle.

■ Correct use of the seat belts

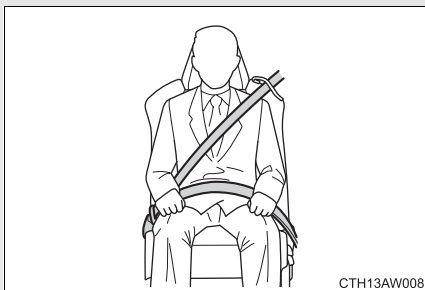

- Extend the shoulder belt so that it comes fully over the shoulder, but does not come into contact with the neck or slide off the shoulder.
- Position the lap belt as low as possible over the hips.
- Adjust the position of the seatback. Sit up straight and well back in the seat.
- Do not twist the seat belt.

■ Fastening and releasing the seat belt

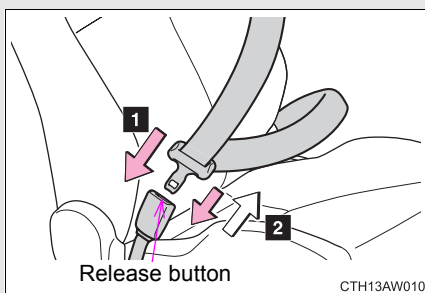

- 1** Fasten the seat belt
Push the plate into the buckle until a click sound is heard.
- 2** Release the seat belt
Press the release button.

Front seat belt guide

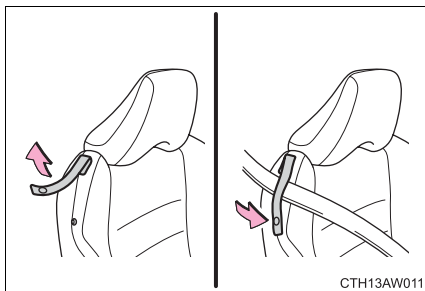

To enable the seat belt to be easily extended, pass the seat belt through the guide.

When getting in or out of the rear seats, release the seat belt from the guide.

Seat belt pretensioners (front seats)

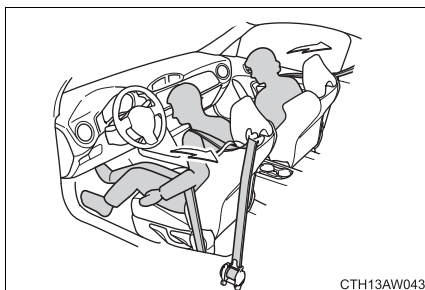

The pretensioner helps the seat belt to quickly restrain the occupant by retracting the seat belt when the vehicle is subjected to certain types of severe frontal collision.

The pretensioner may not activate in the event of a minor frontal impact, a side impact or a rear impact.

■ **Emergency locking retractor (ELR)**

The retractor will lock the belt during a sudden stop or on impact. It may also lock if you lean forward too quickly. A slow, easy motion will allow the belt to extend so that you can move around fully.

■ **Child seat belt usage**

The seat belts of your vehicle are principally designed for persons of adult size.

- Use a child restraint system appropriate for the child, until the child becomes large enough to properly wear the vehicle's seat belt. (→P. 134)
- When the child becomes large enough to properly wear the vehicle's seat belt, follow the instructions on P. 72 regarding seat belt usage.

■ **Seat belt pretensioners**

- Seat belt pretensioners are not designed to activate in minor frontal or side impact, in side or rear impacts or in roll-over accidents.
- The following four components operate simultaneously.
 - Seat belt pretensioner for driver
 - Seat belt pretensioner for front passenger
 - SRS frontal airbag for driver
 - SRS frontal airbag for front passenger
- Pretensioners are designed to function on a one-time-only basis. In the event that a pretensioner is activated, both the driver's and front passenger's seat belt retractor assemblies must be replaced only by any authorized Toyota dealer or repairer, or another duly qualified and equipped professional. When replacing seat belt retractor assemblies for the front seating positions, use only genuine Toyota parts equipped with a force limiter.
- If either front seat belt does not retract or cannot be pulled out due to a malfunction or activation of the pretensioner, contact any authorized Toyota dealer or repairer, or another duly qualified and equipped professional as soon as possible.
- If the front seat belt retractor assembly or surrounding area has been damaged, contact any authorized Toyota dealer or repairer, or another duly qualified and equipped professional as soon as possible.

- When you sell your vehicle, we urge you to explain to the buyer that it has seat belt pretensioners by alerting the buyer to the contents of this section.

■ Replacing the belt after the pretensioner has been activated

If the vehicle is involved in multiple collisions, the pretensioner will activate for the first collision, but will not activate for the second or subsequent collisions.

■ Seat belt regulations

If seat belt regulations exist in the country where you reside, please contact any authorized Toyota dealer or repairer, or another duly qualified and equipped professional, for seat belt replacement or installation.

CAUTION

Observe the following precautions to reduce the risk of injury in the event of sudden braking, sudden swerving or an accident. Failure to do so may cause death or serious injury.

■ Wearing a seat belt

- Ensure that all passengers wear a seat belt.
- Always wear a seat belt properly.
- Each seat belt should be used by one person only. Do not use a seat belt for more than one person at once, including children.
- Toyota recommends that children be seated in the rear seat and always use a seat belt and/or an appropriate child restraint system.
- To achieve a proper seating position, do not recline the seat more than necessary. The seat belt is most effective when the occupants are sitting up straight and well back in the seats.
- Do not wear the shoulder belt under your arm.
- Always wear your seat belt low and snug across your hips.

⚠ CAUTION

■ Pregnant women

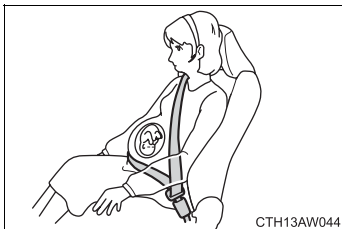

Obtain medical advice and wear the seat belt in the proper way. (→P. 72)

Women who are pregnant should position the lap belt as low as possible over the hips in the same manner as other occupants. Extend the shoulder belt completely over the shoulder and position the belt across the chest. Avoid belt contact over the rounding of the abdominal area.

If the seat belt is not worn properly, not only pregnant woman, but also the fetus could suffer death or serious injury as a result of sudden braking or a collision.

■ People with a medical condition

Obtain medical advice and wear the seat belt in the proper way.

■ When children are in the vehicle

Do not allow children to play with the seat belt. If the seat belt becomes twisted around a child's neck, it may lead to choking or other serious injuries that could result in death.

If this occurs and the buckle cannot be unfastened, scissors should be used to cut the belt.

 **CAUTION****■ Seat belt pretensioners**

- If the pretensioner has activated, the SRS warning light will come on. In that case, the seat belt cannot be used again and must be replaced at any authorized Toyota dealer or repairer, or another duly qualified and equipped professional.
- To obtain maximum protection, the occupants should sit in an upright position with their seat belts properly fastened.
- Do not modify, remove or strike the front seat belt retractor assemblies or surrounding area. This could result in accidental activation of the seat belt pretensioners or could make the system inoperative, possibly resulting in serious injury. Seat belt pretensioners have no user-serviceable parts. For required servicing of front seat belt retractors equipped with seat belt pretensioners, see any authorized Toyota dealer or repairer, or another duly qualified and equipped professional.
- When discarding front seat belt retractor assemblies or scrapping the entire vehicle due to collision damage or for other reasons, consult any authorized Toyota dealer or repairer, or another duly qualified and equipped professional.

■ Seat belt damage and wear

- Do not damage the seat belts by allowing the belt, plate, or buckle to be jammed in the door.
- Inspect the seat belt system periodically. Check for cuts, fraying, and loose parts. Do not use a damaged seat belt until it is replaced. Damaged seat belts cannot protect an occupant from death or serious injury.
- Ensure that the belt and plate are locked and the belt is not twisted. If the seat belt does not function correctly, immediately contact any authorized Toyota dealer or repairer, or another duly qualified and equipped professional.
- Replace the seat assembly, including the belts, if your vehicle has been involved in a serious accident, even if there's no obvious damage.

⚠ CAUTION

- Do not attempt to install, remove, modify, disassemble or dispose of the seat belts. Have any necessary repairs carried out by any authorized Toyota dealer or repairer, or another duly qualified and equipped professional. Inappropriate handling of the pretensioner may prevent it from operating properly, resulting in death or serious injury.

■ **When using the seat belt guide**

- Always make sure that the belt is not twisted, and runs freely through the guide.
- Regardless of whether the guide is used or not, always secure the seat belt guide button.
- Do not hang from or pull the guide forcefully.

■ **Before using the rear seat belts**

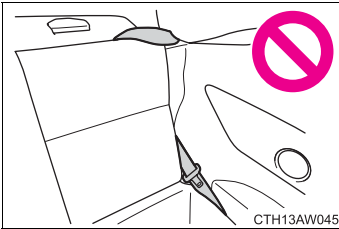

Always make sure that the seat belt is not caught in the seatback or twisted in one of the hooks that secure the seatback. Failure to do so may cause the seat belt to not be fastened correctly or to become ineffective in a collision, resulting in death or serious injury.

1-3. Adjustable components (seats, mirrors, steering wheel)

Steering wheel

The steering wheel can be adjusted to a comfortable position.

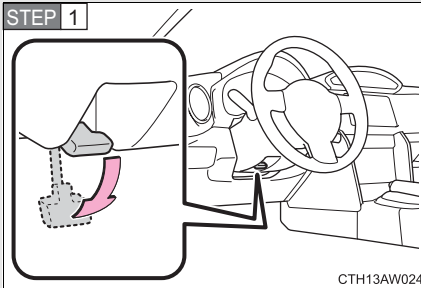

Hold the steering wheel and push the lever down.

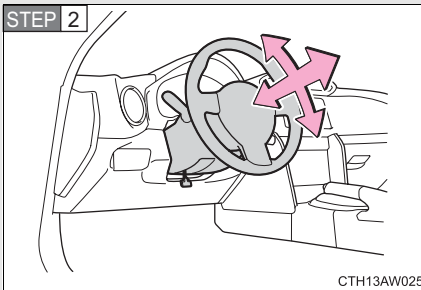

Adjust to the ideal position by moving the steering wheel horizontally and vertically.

After adjustment, pull the lever up to secure the steering wheel.

⚠ CAUTION

■ Caution while driving

Do not adjust the steering wheel while driving. Doing so may cause the driver to mishandle the vehicle and an accident, resulting in death or serious injury.

■ After adjusting the steering wheel

Make sure that the steering wheel is securely locked. Otherwise, the steering wheel may move suddenly, possibly causing an accident, and resulting in death or serious injury.

1-3. Adjustable components (seats, mirrors, steering wheel) Anti-glare inside rear view mirror

The rear view mirror's position can be adjusted to enable sufficient confirmation of the rear view in accordance with the driver's seating posture.

Adjusting the height of rear view mirror

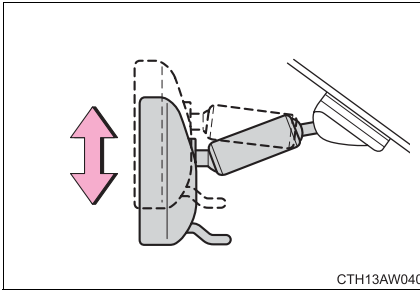

Adjust the height of the rear view mirror by moving it up and down.

Anti-glare function

Reflected light from the headlamps of vehicles behind can be reduced by operating the lever.

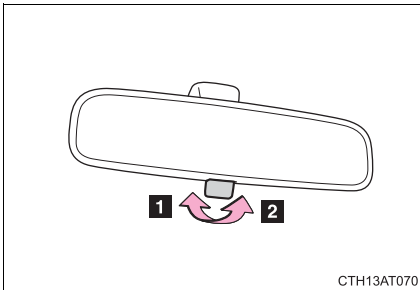

- 1** Normal position
- 2** Anti-glare position

CAUTION

Caution while driving

Do not adjust the position of the mirror while driving.
Doing so may lead to mishandling of the vehicle and cause an accident, resulting in death or serious injury.

1-3. Adjustable components (seats, mirrors, steering wheel)

Outside rear view mirrors

Mirror angle can be adjusted using the switch.

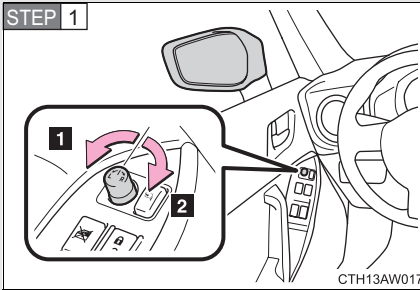

Select a mirror to adjust.

- 1** Left
- 2** Right

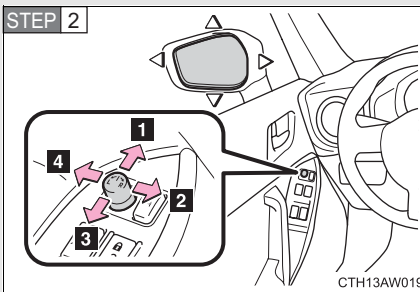

Adjust the mirror.

- 1** Up
- 2** Right
- 3** Down
- 4** Left

Folding the mirrors

Manual operation

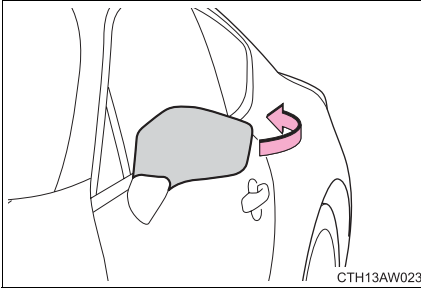

Push the mirror back in the direction of the vehicle's rear.

Power operation (if equipped)

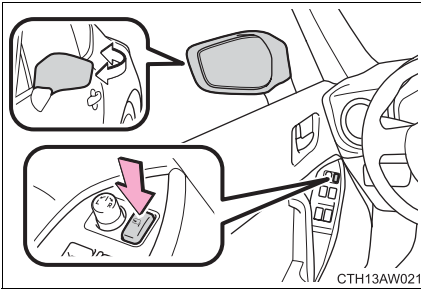

Press the switch to fold the mirrors.

Press it again to extend them to the original position.

■ The mirrors can be adjusted when

Vehicles without a smart entry & start system

The engine switch is in the "ACC" or "ON" position.

Vehicles with a smart entry & start system

The "ENGINE START STOP" switch is in ACCESSORY or IGNITION ON mode.

■ When the mirrors are fogged up (vehicles with outside rear view mirror defoggers)

The outside rear view mirrors can be cleared using the mirror defoggers. Turn on the rear window defogger to turn on the outside rear view mirror defoggers. (→P. 256)

 **CAUTION****■ When driving the vehicle**

Observe the following precautions while driving.

Failure to do so may result in loss of control of the vehicle and cause an accident, resulting in death or serious injury.

- Do not adjust the mirrors while driving.
- Do not drive with the mirrors folded.
- Both the driver and passenger side mirrors must be extended and properly adjusted before driving.

■ When a mirror is moving

To avoid personal injury and mirror malfunction, be careful not to get your hand caught by the moving mirror.

■ When the mirror defoggers are operating (vehicles with outside rear view mirror defoggers)

Do not touch the rear view mirror surfaces, as they can become very hot and burn you.

1-4. Opening and closing the windows

Power windows

The power windows can be opened and closed using the switches.

Operating the switch moves the windows as follows:

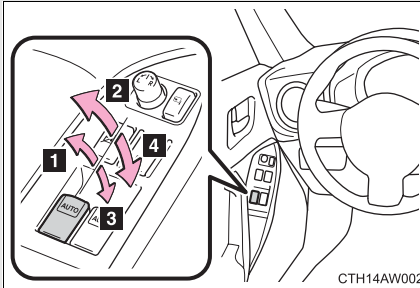

- 1 Closing
- 2 One-touch closing*
- 3 Opening
- 4 One-touch opening*

*: Pushing the switch in the opposite direction will stop window travel partway.

Window lock switch

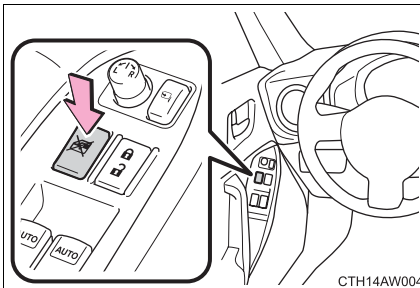

Press the switch down to lock the passenger window glasses.

Use this switch to prevent children from accidentally opening or closing a passenger window.

■ The power windows can be operated when**Vehicles without a smart entry & start system**

The engine switch is in the “ON” position.

Vehicles with a smart entry & start system

The “ENGINE START STOP” switch is in IGNITION ON mode.

■ Operating the power windows after turning the engine off**Vehicles without a smart entry & start system**

The power windows can be operated for approximately 45 seconds even after the engine switch is turned to the “ACC” or “LOCK” position. They cannot, however, be operated once either door is opened.

Vehicles with a smart entry & start system

The power windows can be operated for approximately 45 seconds even after the “ENGINE START STOP” switch is turned to ACCESSORY mode or turned off. They cannot, however, be operated once either door is opened.

■ Jam protection function

If an object becomes caught between the window and the body, window travel is stopped and the window is opened slightly.

■ When the power window does not close normally

If the jam protection function is operating abnormally and a window cannot be closed, close all the doors and perform the following operations using the power window switch on the relevant door.

STEP 1 Vehicles without a smart entry & start system: After stopping the vehicle, the engine switch is turned to the “ON” position.

Vehicles with a smart entry & start system: After stopping the vehicle, the “ENGINE START STOP” switch is turned to IGNITION ON mode.

STEP 2 Hold the power window switch in the one-touch closing position two consecutive times.

STEP 3 Hold the power window switch in the one-touch closing position once again and continue holding for 1 second or more after the window closes completely.

If you push the power window switch to the opening position while the window is moving, start again from the beginning. If the window continues to close but then re-open slightly even after performing the above procedure correctly, have the vehicle inspected by any authorized Toyota dealer or repairer, or another duly qualified and equipped professional.

 **CAUTION****■ Closing the windows**

Observe the following precautions.

Failure to do so may result in death or serious injury.

- The driver is responsible for all the power window operations, including the operation for the passengers. In order to prevent accidental operation, especially by a child, do not let a child operate the power windows. It is possible for children and other passengers to have body parts caught in the power window. Also, when riding with a child, it is recommended to use the window lock switch. (→P. 84)
- Check to make sure that all passengers do not have any part of their body in a position where it could be caught when a window is being operated.
- When exiting the vehicle, turn the engine switch (vehicles without a smart entry & start system) or the “ENGINE START STOP” switch (vehicles with a smart entry & start system) off, carry the key and exit the vehicle along with the child. There may be accidental operation, due to mischief, etc., that may possibly lead to an accident.

■ Jam protection function

- Never use any part of your body to intentionally activate the jam protection function.
- The jam protection function may not work if something gets caught just before the window fully closes.

1-5. Refueling

Opening the fuel tank cap

Perform the following steps to open the fuel tank cap:

■ Before refueling the vehicle

- Vehicles without a smart entry & start system: Turn the engine switch off and ensure that all the doors and windows are closed.
- Vehicles with a smart entry & start system: Turn the “ENGINE START STOP” switch off and ensure that all the doors and windows are closed.
- Confirm the type of fuel. (→P. 89)

■ Opening the fuel tank cap

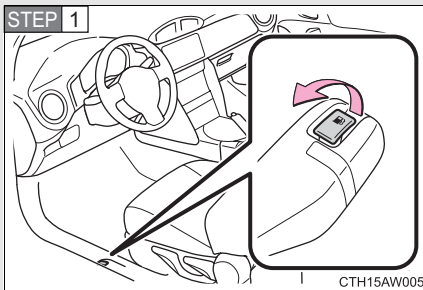

Pull up the opener to open the fuel filler door.

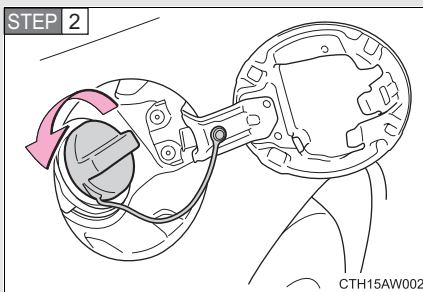

Turn the fuel tank cap slowly to open.

STEP 3

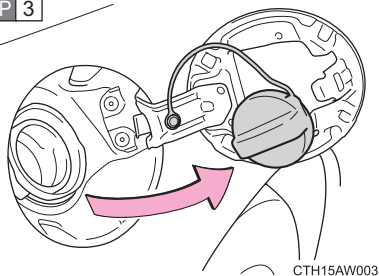

Hang the fuel tank cap on the back of the fuel filler door.

Closing the fuel tank cap

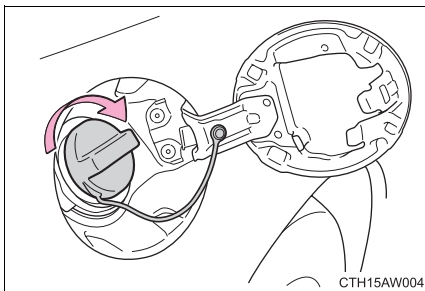

After refueling, turn the fuel tank cap until you hear a click. Once the cap is released, it will turn slightly in the opposite direction.

Fuel types

EU area:

Unleaded gasoline confirming to European standard EN228, Research Octane Number of 98 or higher

Except EU area:

Unleaded gasoline, Research Octane Number of 98 or higher

If unleaded gasoline with an octane rating of 98 RON is not available, unleaded gasoline with an octane rating of 95 RON may be used with no detriment to engine durability or driveability.

Use of ethanol blended gasoline in a gasoline engine

Toyota allows the use of ethanol blended gasoline where the ethanol content is up to 10%. Make sure that the ethanol blended gasoline to be used has a Research Octane Number that follows the above.

 CAUTION

■ **Refueling the vehicle**

Observe the following precautions while refueling the vehicle.
Failure to do so may result in death or serious injury.

- Do not handle fuel indoors.
- After exiting the vehicle and before opening the fuel door, touch an unpainted metal surface to discharge any static electricity. It is important to discharge static electricity before refueling because sparks resulting from static electricity can cause fuel vapors to ignite while refueling.
- Always hold the grips on the fuel tank cap and turn it slowly to remove it. A whooshing sound may be heard when the fuel tank cap is loosened. Wait until the sound cannot be heard before fully removing the cap. In hot weather, pressurized fuel may spray out of the filler neck and cause injury.
- Do not allow anyone that has not discharged static electricity from their body to come close to an open fuel tank.
- Do not allow others to approach the area of the vehicle near the fuel filler pipe while refueling is in progress.
- Do not inhale vaporized fuel.
Fuel contains substances that are harmful if inhaled.
- Do not smoke while refueling the vehicle.
Doing so may cause the fuel to ignite and cause a fire.
- Do not return to the vehicle or touch any person or object that is statically charged.
This may cause static electricity to build up, resulting in a possible ignition hazard.

 **CAUTION****■ When refueling**

Observe the following precautions to prevent fuel overflowing from the fuel tank:

- Securely insert the fuel nozzle into the fuel filler neck.
- Stop filling the tank after the fuel nozzle automatically clicks off.
- Do not top off the fuel tank.
- Observe other precautions that are posted at the service station.
- Turn the cap to the right until it clicks to ensure that it is fully tightened. If the cap is not securely tightened, fuel spillage could occur in the event of an accident, creating a fire hazard.

■ When replacing the fuel cap

Do not use anything but a genuine Toyota fuel tank cap designed for your vehicle. Doing so may cause a fire or other incident which may result in death or serious injury.

 **NOTICE****■ Refueling**

- Do not spill fuel during refueling.
Doing so may damage the vehicle, such as causing the emission control system to operate abnormally or damaging fuel system components or the vehicle's painted surface.
- Never add any cleaning agents to the fuel tank. The addition of a cleaning agent may cause damage to the fuel system.
- Immediately put fuel in the tank whenever the low fuel warning light illuminates. Engine misfires as a result of an empty tank could cause damage to the engine.

1-6. Theft deterrent system

Engine immobilizer system

The vehicle's keys have built-in transponder chips that prevent the engine from starting if the key has not been previously registered in the vehicle's on-board computer.

Never leave the keys inside the vehicle when you leave the vehicle.

This system is designed to help prevent vehicle theft but does not guarantee absolute security against all vehicle thefts.

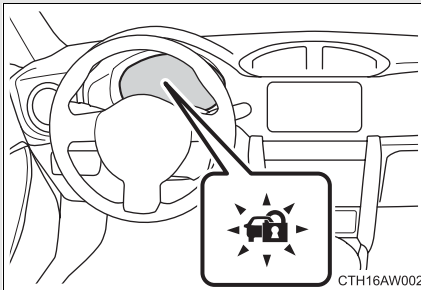

Vehicles without a smart entry & start system

The indicator light flashes after the key has been removed from the engine switch to indicate that the system is operating.

The indicator light stops flashing after the registered key has been inserted into the engine switch to indicate that the system has been canceled.

Vehicles with a smart entry & start system

The indicator light flashes after the “ENGINE START STOP” switch has been turned off to indicate that the system is operating.

The indicator light stops flashing after the “ENGINE START STOP” switch has been turned to ACCESSORY or IGNITION ON mode to indicate that the system has been canceled.

■ When the vehicle cannot be started with the registered key (vehicles without a smart entry & start system)

Remove the key and try again.

■ System maintenance

The vehicle has a maintenance-free type engine immobilizer system.

■ Conditions that may cause the system to malfunction

- If the key is in contact with a metallic object
- If the key is in close proximity to or touching a key to the security system (key with a built-in transponder chip) of another vehicle

■ Certification for engine immobilizer system (vehicles with a smart entry & start system)



FUJI HEAVY INDUSTRIES LTD.
SUBARU ENGINEERING DIVISION
1-1 SUBARU-CHO OTA GUNMA 373-8555 JAPAN
Phone: +81 276-26-2381 Fax: +81 276-26-2397

R&TTE Declaration of Conformity

We,

Manufacturer's Name: Fuji Heavy Industries Ltd.
Manufacturer's Address: 1-7-2, Nishishinjuku, Shinjuku, Tokyo, 160-8316 Japan

hereby declare under our sole responsibility that the product:

Product Name: Immobilizer
Product Model: SSPIMB03

to which this declaration relates is in conformity with the essential requirements and other relevant requirements of the R&TTE Directive (1999/5/EC). The product is compliant with the following standards and/or other normative documents:

- Health & safety requirements: EN60950-1
- EMC requirements: EN301 489-1 & EN301 489-3
- Effective uses of radio spectrum: EN300 330-2

Supplementary information:

* CE mark	
* Member states intended for use	EU and EFTA

Date: February 14, 2011

Signature: *Takashi Nishida*
Takashi Nishida

Hereby, Fuji Heavy Industries Ltd., declares that this SSPIMB03 is in compliance with the essential requirements and other relevant provisions of Directive 1999/5/EC.

Fuji Heavy Industries Ltd. vakuuttaa täten että SSPIMB03 tyyppinen laite on direktiivin 1999/5/EY oleellisten vaatimusten ja sitä koskevien direktiivin muiden ehtojen mukainen.

Hierbij verklaart Fuji Heavy Industries Ltd. dat het toestel SSPIMB03 in overeenstemming is met de essentiële eisen en de andere relevante bepalingen van richtlijn 1999/5/EG.

Par la présente Fuji Heavy Industries Ltd. déclare que l'appareil SSPIMB03 est conforme aux exigences essentielles et aux autres dispositions pertinentes de la directive 1999/5/CE.

Härmed intygar Fuji Heavy Industries Ltd. att denna SSPIMB03 står i överensstämmelse med de väsentliga egenskapskrav och övriga relevanta bestämmelser som framgår av direktiv 1999/5/EG.

Undertegnede Fuji Heavy Industries Ltd. erklærer herved, at følgende udstyr SSPIMB03 overholder de væsentlige krav og øvrige relevante krav i direktiv 1999/5/EF.

Hiermit erklärt Fuji Heavy Industries Ltd., dass sich das Gerät SSPIMB03 in Übereinstimmung mit den grundlegenden Anforderungen und den übrigen einschlägigen Bestimmungen der Richtlinie 1999/5/EG befindet.

ΜΕ ΤΗΝ ΠΑΡΟΥΣΑ Fuji Heavy Industries Ltd. ΔΗΛΩΝΕΙ ΟΤΙ SSPIMB03 ΣΥΜΜΟΡΦΩΝΕΤΑΙ ΠΡΟΣ ΤΙΣ ΟΥΣΙΩΔΕΙΣ ΑΠΑΙΤΗΣΕΙΣ ΚΑΙ ΤΙΣ ΛΟΙΠΕΣ ΣΧΕΤΙΚΕΣ ΔΙΑΤΑΞΕΙΣ ΤΗΣ ΟΔΗΓΙΑΣ 1999/5/ΕΚ.

Con la presente Fuji Heavy Industries Ltd. dichiara che questo SSPIMB03 è conforme ai requisiti essenziali ed alle altre disposizioni pertinenti stabilite dalla direttiva 1999/5/CE.

Por medio de la presente Fuji Heavy Industries Ltd. declara que el SSPIMB03 cumple con los requisitos esenciales y cualesquiera otras disposiciones aplicables o exigibles de la Directiva 1999/5/CE.

Fuji Heavy Industries Ltd. declara que este SSPIMB03 está conforme com os requisitos essenciais e outras disposições da Directiva 1999/5/CE.

Hawnhekk, Fuji Heavy Industries Ltd., jiddikjara li dan SSPIMB03 jikkonforma mal-ftiġġijiet essenzjali u ma provvediment i oħrajn relevanti li hemm fid-Dirrettiva 1999/5/EC:

Käesolevaga kinnitab Fuji Heavy Industries Ltd. seadme SSPIMB03 vastavust direktiivi 1999/5/EÜ põhinõuetele ja nimetatud direktiivist tulenevatele teistele asjakohastele sätetele.

Alulírott, Fuji Heavy Industries Ltd. nyilatkozom, hogy a SSPIMB03 megfelel a vonatkozó alapvető követelményeknek és az 1999/5/EC irányelv egyéb előírásainak.

Fuji Heavy Industries Ltd. tímto vyhlasuje, že SSPIMB03 splňa základné požiadavky a všetky príslušné ustanovenia Smernice 1999/5/ES.

Fuji Heavy Industries Ltd. tímto prohlašuje, že tento SSPIMB03 je ve shodě se základními požadavky a dalšími příslušnými ustanoveními směrnice 1999/5/ES.

Fuji Heavy Industries Ltd. izjavlja, da je ta SSPIMB03 v skladu z bistvenimi zahtevami in ostalimi relevantnimi določili direktive 1999/5/ES.

Šiuo Fuji Heavy Industries Ltd. deklaruoja, kad šis SSPIMB03 atitinka esminius reikalavimus ir kitas 1999/5/EB Direktyvos nuostatas.

Ar šo Fuji Heavy Industries Ltd. deklarē, ka SSPIMB03 atbilst Direktīvas 1999/5/EK būtiskajām prasībām un citiem ar to saistītajiem noteikumiem.

Niniejszym Fuji Heavy Industries Ltd. oświadcza, że SSPIMB03 jest zgodny z zasadniczymi wymogami oraz pozostałymi stosownymi postanowieniami Dyrektywy 1999/5/EC.

Hér með lýsir Fuji Heavy Industries Ltd. yfir því að SSPIMB03 er í samræmi við grunnkröfur og aðrar kröfur, sem gerðar eru í tilskipun 1999/5/EC.

Fuji Heavy Industries Ltd. erklærer herved at utstyret SSPIMB03 er i samsvar med de grunnleggende krav og øvrige relevante krav i direktiv 1999/5/EF.

С настоящето, Fuji Heavy Industries Ltd., декларира, че SSPIMB03 е в съответствие със съществените изисквания и другите приложими разпоредби на Директива 1999/5/EC.

Prin prezenta, Fuji Heavy Industries Ltd., declară că aparatul SSPIMB03 este în conformitate cu cerințele esențiale și cu alte prevederi pertinente ale Directivei 1999/5/CE.

Ovim, Fuji Heavy Industries Ltd., izjavljuje da ovaj SSPIMB03 je usklađen sa bitnim zahtjevima i drugim relevantnim odredbama Direktive 1999/5/EC.

Ovim Fuji Heavy Industries Ltd., izjavljuje da je SSPIMB03 u skladu s bitnim zahtjevima i drugim relevantnim odredbama Direktive 1999/5/EC i Pravilnika o RITT opremi (NN 25/2012).

Ovim, Fuji Heavy Industries Ltd., deklarirše da je SSPIMB03 u skladu sa osnovnim zahtevima i ostalim relevantnim odredbama Direktive 1999/5/EC.

■ Certification for engine immobilizer system (vehicles without a smart entry & start system)

Hereby, Tokai Rika Co., Ltd., declares that this RI-38BFH is in compliance with the essential requirements and other relevant provisions of Directive 1999/5/EC.

Tokai Rika Co., Ltd. vakuuttaa täten että RI-38BFH tyyppinen laite on direktiivin 1999/5/EY oleellisten vaatimusten ja sitä koskevien direktiivin muiden ehtojen mukainen.

Hierbij verklaart Tokai Rika Co., Ltd. dat het toestel RI-38BFH in overeenstemming is met de essentiële eisen en de andere relevante bepalingen van richtlijn 1999/5/EG.

Par la présente Tokai Rika Co., Ltd. déclare que l'appareil RI-38BFH est conforme aux exigences essentielles et aux autres dispositions pertinentes de la directive 1999/5/CE.

Härmed intygar Tokai Rika Co., Ltd. att denna RI-38BFH står i överensstämmelse med de väsentliga egenskapskrav och övriga relevanta bestämmelser som framgår av direktiv 1999/5/EG.

Undertegnede Tokai Rika Co., Ltd. erklærer herved, at følgende udstyr RI-38BFH overholder de væsentlige krav og øvrige relevante krav i direktiv 1999/5/EF.

Hiermit erklärt Tokai Rika Co., Ltd., dass sich das Gerät RI-38BFH in Übereinstimmung mit den grundlegenden Anforderungen und den übrigen einschlägigen Bestimmungen der Richtlinie 1999/5/EG befindet.

ΜΕ ΤΗΝ ΠΑΡΟΥΣΑ Tokai Rika Co., Ltd. ΔΗΛΩΝΕΙ ΟΤΙ RI-38BFH ΣΥΜΜΟΡΦΩΝΕΤΑΙ ΠΡΟΣ ΤΙΣ ΟΥΣΙΩΔΕΙΣ ΑΠΑΙΤΗΣΕΙΣ ΚΑΙ ΤΙΣ ΛΟΙΠΕΣ ΣΧΕΤΙΚΕΣ ΔΙΑΤΑΞΕΙΣ ΤΗΣ ΟΔΗΓΙΑΣ 1999/5/ΕΚ.

Con la presente Tokai Rika Co., Ltd. dichiara che questo RI-38BFH è conforme ai requisiti essenziali ed alle altre disposizioni pertinenti stabilite dalla direttiva 1999/5/CE.

Por medio de la presente Tokai Rika Co., Ltd. declara que el RI-38BFH cumple con los requisitos esenciales y cualesquiera otras disposiciones aplicables o exigibles de la Directiva 1999/5/CE.

Tokai Rika Co., Ltd. declara que este RI-38BFH está conforme com os requisitos essenciais e outras disposições da Directiva 1999/5/CE.

Hawnhekk, Tokai Rika Co., Ltd., jiddikjara li dan RI-38BFH jikkonforma mal-htigijiet essenzjali u ma provvedimenti oħrajn relevanti li hemm fid-Direttiva 1999/5/EC.

Käesolevaga kinnitab Tokai Rika Co., Ltd. seadme RI-38BFH vastavust direktiivi 1999/5/EÜ põhinõuetele ja nimetatud direktiivist tulenevatele teistele asjakohastele sätetele.

Alulírott, Tokai Rika Co., Ltd. nyilatkozom, hogy a RI-38BFH megfelel a vonatkozó alapvető követelményeknek és az 1999/5/EC irányelv egyéb előírásainak.

Tokai Rika Co., Ltd. tímto vyhlasuje, že RI-38BFH splňa základné požiadavky a všetky príslušné ustanovenia Smernice 1999/5/ES.

Tokai Rika Co., Ltd. tímto prohlašuje, že tento RI-38BFH je ve shodě se základními požadavky a dalšími příslušnými ustanoveními směrnice 1999/5/ES.

Tokai Rika Co., Ltd. izjavlja, da je ta RI-38BFH v skladu z bistvenimi zahtevami in ostalimi relevantnimi določili direktive 1999/5/ES.

Šiuo Tokai Rika Co., Ltd. deklaruoja, kad šis RI-38BFH atitinka esminius reikalavimus ir kitas 1999/5/EB Direktyvos nuostatas.

Ar šo Tokai Rika Co., Ltd. deklarē, ka RI-38BFH atbilst Direktīvas 1999/5/EK būtiskajām prasībām un citiem ar to saistītajiem noteikumiem.

Niniejszym Tokai Rika Co., Ltd. oświadcza, że RI-38BFH jest zgodny z zasadniczymi wymogami oraz pozostałymi stosownymi postanowieniami Dyrektywy 1999/5/EC.

Hér með lýsir Tokai Rika Co., Ltd. yfir því að RI-38BFH er í samræmi við grunnkröfur og aðrar kröfur, sem gerðar eru í tilskipun 1999/5/EC.

Tokai Rika Co., Ltd. erklærer herved at utstyret RI-38BFH er i samsvar med de grunnleggende krav og øvrige relevante krav i direktiv 1999/5/EF.

С настоящето, Tokai Rika Co., Ltd., декларира, че RI-38BFH е в съответствие със съществените изисквания и другите приложими разпоредби на Директива 1999/5/EC.

Prin prezenta, Tokai Rika Co., Ltd., declară că aparatul RI-38BFH este în conformitate cu cerințele esențiale și cu alte prevederi pertinente ale Directivei 1999/5/CE.

Ovim, Tokai Rika Co., Ltd., izjavljuje da ovaj RI-38BFH je usklađen sa bitnim zahtjevima i drugim relevantnim odredbama Direktive 1999/5/EC.

Nepemjet kesaj, Tokai Rika Co., Ltd., deklaroh qe ky RI-38BFH eshte ne pajtim me kerkesat thelbore dhe dispozitat e tjera perkatese te Direktives 1999/5/EC.

Ovim Tokai Rika Co., Ltd., izjavljuje da je RI-38BFH u skladu s bitnim zahtjevima i drugim relevantnim odredbama Direktive 1999/5/EC i Pravilnika o RiTT opremi (NN 25/2012).

Ovim, Tokai Rika Co., Ltd., deklarirše da je RI-38BFH u skladu sa osnovnim zahtevima i ostalim relevantnim odredbama Direktive 1999/5/EC.

The DECLARATION of CONFORMITY (DoC) is available at the following address:

<http://www.tokai-rika.co.jp/pc/>



NOTICE

■ To ensure the system operates correctly

Do not modify or remove the system. If modified or removed, the proper operation of the system cannot be guaranteed.

1-6. Theft deterrent system

Double locking system*

Unauthorized access to the vehicle is prevented by disabling the door unlocking function from both the interior and exterior of the vehicle.

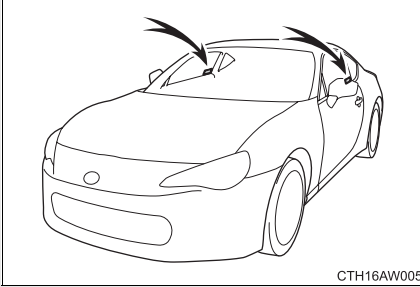

Vehicles employing this system have labels on the window glass of both front doors.

Setting the double locking system

Vehicles without a smart entry & start system: Turn the engine switch off, have all the passengers exit the vehicle and ensure that all the doors are closed.

Vehicles with a smart entry & start system: Turn the “ENGINE START STOP” switch off, have all the passengers exit the vehicle and ensure that all the doors are closed.

Using the entry function (vehicles with a smart entry & start system): Press the lock button on the outside door handle.

Using the wireless remote control:

Press  .

 CAUTION

■ **Double locking system precaution**

Never activate the double locking system when there are people in the vehicle because all the doors cannot be opened from inside the vehicle.

1-7. Safety information

Correct driving posture

Drive with a good posture as follows:

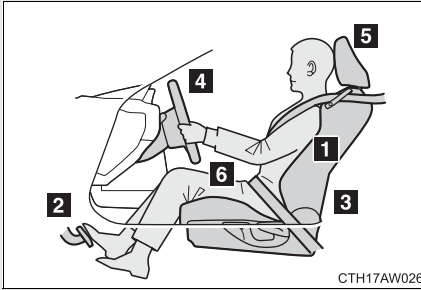

- 1** Sit upright and well back in the seat. (→P. 64)
- 2** Adjust the position of the seat forward or backward to ensure the pedals can be reached and easily depressed to the extent required. (→P. 64)
- 3** Adjust the seatback so that the controls are easily operable. (→P. 64)
- 4** Adjust the tilt and telescopic positions of the steering wheel to allow easy operation and to ensure the air-bag is facing your chest. (→P. 79)
- 5** Lock the head restraint in place with the center of the head restraint closest to the top of your ears. (→P. 70)
- 6** Wear the seat belt correctly. (→P. 72)

 **CAUTION**

■ **While driving**

- Do not adjust the position of the driver's seat.
Doing so could cause the driver to lose control of the vehicle.
- Do not place a cushion between the driver or passenger and the seatback.
A cushion may prevent correct posture from being achieved, and reduce the effectiveness of the seat belt and head restraint, increasing the risk of death or serious injury to the driver or passenger.
- Do not place anything under the front seats.
Objects placed under the front seats may become jammed in the seat tracks and stop the seat from locking in place. This may lead to an accident resulting in serious injury or death. The adjustment mechanism may also be damaged.

■ **Adjusting the seat position**

- Take care when adjusting the seat position to ensure that other passengers are not injured by the moving seat.
- Do not put your hands under the seat or near the moving parts to avoid injury.
Fingers or hands may become jammed in the seat mechanism.

1-7. Safety information

SRS airbag (Supplemental Restraint System airbag)

The SRS airbags inflate when the vehicle is subjected to certain types of severe impacts that may cause significant injury to the occupants. They work together with the seat belts to help reduce the risk of death or serious injury.

SRS: This stands for supplemental restraint system. This name is used because the airbag system supplements the vehicle's seat belts.

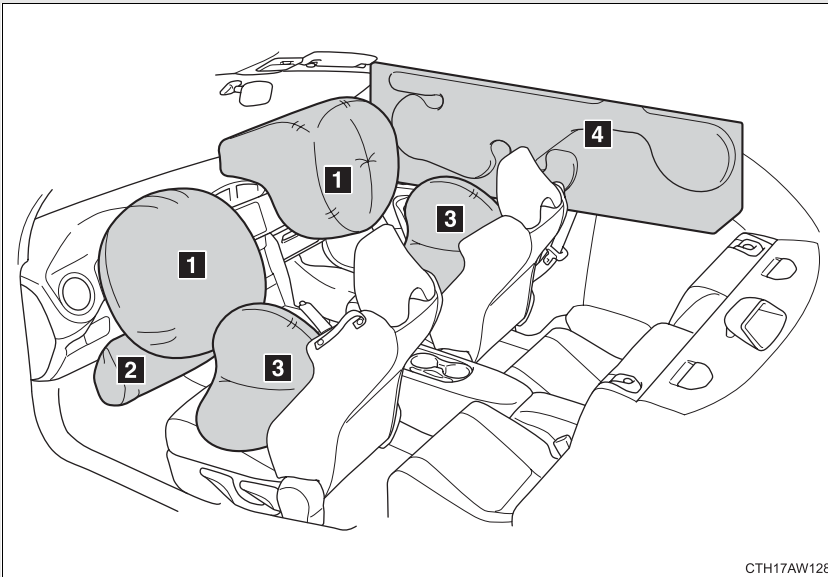

Models with SRS airbags and seat belts for driver, front passenger, and window-side rear passengers

Your vehicle is equipped with a supplemental restraint system to supplement the seat belts for the front seats and rear window-side seating positions.

The supplemental restraint system (SRS) consists of seven airbags. The configurations are as follows.

- 1 Front airbags for driver and front passenger
- 2 Knee airbag for driver
- 3 Side airbags for driver and front passenger
- 4 Curtain shield airbags for driver, front passenger and window-side rear passengers

These SRS airbags are designed only as a supplement to the primary protection provided by the seat belt.

The system also controls front seat belt pretensioners. For operation instructions and precautions concerning the seat belt pretensioner, refer to “Seat belt pretensioners”. (→P. 73)

■ When you sell your vehicle

When you sell your vehicle, we urge you to explain to the buyer that it is equipped with SRS airbags by alerting the buyer to the applicable section in this Owner's Manual.

 **CAUTION****■ SRS airbag**

- To obtain maximum protection in the event of an accident, the driver and all passengers in the vehicle should always wear seat belts when the vehicle is moving. The SRS airbag is designed only to be a supplement to the primary protection provided by the seat belt. It does not eliminate the need to fasten seat belts. In combination with the seat belts, it offers the best combined protection in case of a serious accident.

Not wearing a seat belt increases the chance of severe injury or death in a crash even when the vehicle has the SRS airbag.

For instructions and precautions concerning the seat belt system, refer to "Seat belts". (→P. 72)

- Do not sit or lean unnecessarily close to the SRS airbag. Because the SRS airbag deploys with considerable speed - faster than the blink of an eye - and force to protect in high speed collisions, the force of an airbag can injure an occupant whose body is too close to SRS airbag.

It is also important to wear your seat belt to help avoid injuries that can result when the SRS airbag contacts an occupant not in proper position such as one thrown forward during pre-accident braking.

Even when properly positioned, there remains a possibility that an occupant may suffer minor injury such as abrasions and bruises to the face or arms because of the SRS airbag deployment force.

- The SRS airbags deploy with considerable speed and force. Occupants who are out of proper position when the SRS airbag deploys could suffer very serious injuries. Because the SRS airbag needs enough space for deployment, the driver should always sit upright and well back in the seat as far from the steering wheel as practical while still maintaining full vehicle control and the front passenger should move the seat as far back as possible and sit upright and well back in the seat.
- Do not place any objects over or near the SRS airbag cover or between you and the SRS airbag. If the SRS airbag deploys, those objects could interfere with its proper operation and could be propelled inside the vehicle and cause injury.

! CAUTION

■ SRS airbag

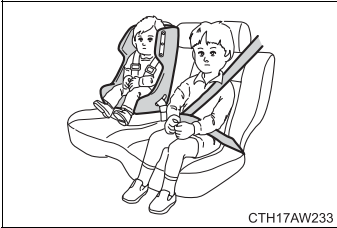

- Put children in the REAR seat properly restrained at all times in a child restraint device or in a seat belt, whichever is appropriate for the child's age, height and weight. The SRS airbag deploys with considerable speed and force and can injure or even kill children, especially if they are not restrained or improperly restrained. Because children are lighter and weaker than adults, their risk of being injured from deployment is greater.

Secure ALL types of child restraint devices (including forward facing child seats) in the REAR seats at all times.

According to accident statistics, children are safer when properly restrained in the rear seating positions than in the front seating positions.

For instructions and precautions concerning the child restraint system, refer to "Child restraint systems". (→P. 134)

- NEVER INSTALL A REARWARD FACING CHILD SEAT IN THE FRONT SEAT. DOING SO RISKS SERIOUS INJURY OR DEATH TO THE CHILD BY PLACING THE CHILD'S HEAD TOO CLOSE TO THE SRS AIRBAG.
- Never allow a child to stand up or kneel on the front passenger's seat, or never hold a child on your lap or in your arms. The SRS airbag deploys with considerable force and can injure or even kill the child.
- A deploying SRS airbag releases hot gas. Occupants could get burned if they come into direct contact with the hot gas.

**NOTICE****■ When the SRS airbag deploys**

When the SRS airbag deploys, some smoke will be released. This smoke could cause breathing problems for people with a history of asthma or other breathing trouble. If you or your passengers have breathing problems after SRS airbag deploys, get fresh air promptly.

SRS airbag system components

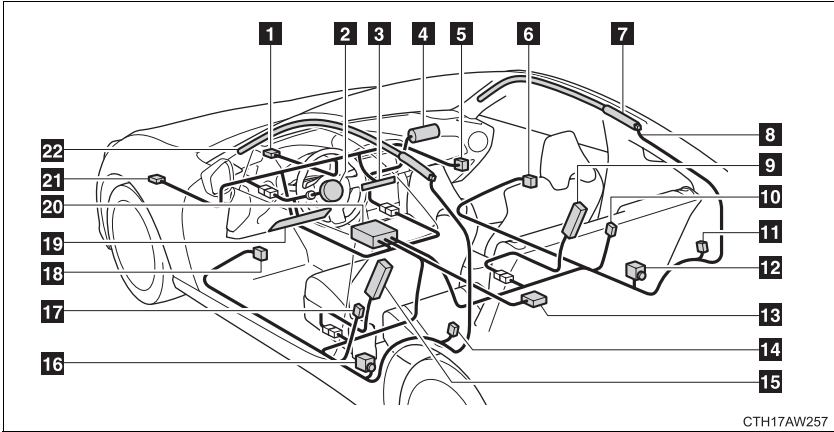

CTH17AW257

- 1** Front sub sensor (right-hand side)
- 2** Front airbag module (driver's side)
- 3** Front passenger's front airbag ON and OFF indicator (center of instrument panel)
- 4** Front airbag module (front passenger's side)
- 5** Front passenger's front airbag cut off switch (passenger's side of instrument panel)
- 6** Door impact sensor (right-hand side)
- 7** Curtain shield airbag module (right-hand side)
- 8** Airbag wiring
- 9** Side airbag module (front passenger's side)
- 10** Side airbag sensor (center pillar right-hand side)
- 11** Curtain shield airbag sensor (rear wheel house right-hand side)
- 12** Seat belt pretensioner (front passenger's side)
- 13** Satellite safing sensor (under the center of the rear seats)
- 14** Curtain shield airbag sensor (rear wheel house left-hand side)
- 15** Side airbag module (driver's side)
- 16** Seat belt pretensioner (driver's side)
- 17** Side airbag sensor (center pillar left-hand side)

- | | |
|--|---|
| 18 Door impact sensor (left-hand side) | 21 Front sub sensor (left-hand side) |
| 19 Driver's knee airbag module | 22 Curtain shield airbag module (left-hand side) |
| 20 Airbag control module (including impact sensors) | |

The main SRS airbag system components are shown above. The SRS airbag system is controlled by the airbag control module. The airbag control module consists of an airbag sensor.

In certain types of severe front or side impacts, the SRS airbag system triggers the airbag inflators. A chemical reaction in the inflators quickly fills the airbags with non-toxic gas to help restrain the motion of the occupants.

SRS front airbag

The driver's SRS front airbag is stowed in the center portion of the steering wheel. The driver's knee airbag is stowed under the steering column. The passenger's SRS front airbag is stowed near the top of the dashboard under an "SRS AIRBAG" mark.

In a moderate to severe front collision, the following components deploy.

- SRS front airbag for driver
- SRS front airbag for front passenger
- Knee airbag for driver

These components supplement the seat belts by reducing the impact to the occupant's head, chest and knees.

■ If the SRS airbags deploy (inflate)

- Bruising and slight abrasions may result from contact with a deploying (inflating) SRS airbag.
- A loud noise and white powder will be emitted.
- Parts of the airbag module (steering wheel hub, airbag cover and inflator) as well as the front seats, parts of the front and rear pillars, and roof side rails, may be hot for several minutes. The airbag itself may also be hot.
- The windshield may crack.

■ Front-seat passenger airbag manual cut off switch

The passenger-side front airbag can be deactivated by the cut off switch located in the instrumental panel side. When the cut off switch is turned to the deactivation mode the passenger-side front airbag becomes deactivated. When the cutoff switch is turned to the activation mode the passenger-side front airbag becomes active to deploy. While the passenger-side front airbag is active the A/B ON indicator is illuminated.

■ Normal operation

Airbag system \ Airbag manual on-off switch	ON	OFF
Front airbag for front passenger	Activated	Deactivated
Seat belt pretensioner for front passenger	Activated	Activated
Side air bag for front passenger		
Curtain shield air bag for front passenger		
SRS warning light	Not illuminated	Not illuminated
Airbag manual on-off indicator "ON"	Illuminated	Not illuminated
Airbag manual on-off indicator "OFF"	Not illuminated	Illuminated

■ When the system is malfunctioning

Airbag system	Operation
Front airbag for front passenger	Deactivated
Seat belt pretensioner for front passenger	Activated
Side air bag for front passenger	
Curtain shield air bag for front passenger	
SRS warning light	Illuminated
Airbag manual on-off indicator "ON"	Not illuminated
Airbag manual on-off indicator "OFF"	Illuminated

■ Operation

Driver's side

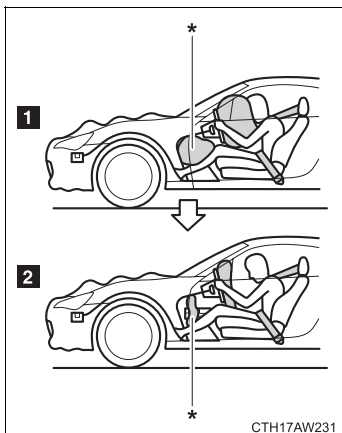

*: Models with knee airbag

Passenger's side

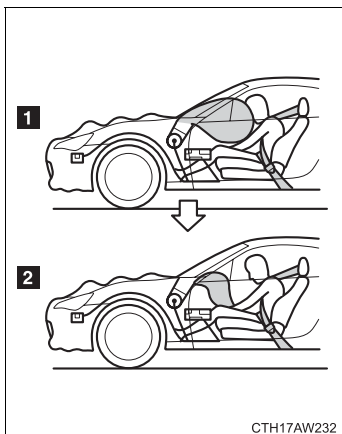

1 SRS AIRBAGs deploy as soon as a collision occurs.

2 After deployment, SRS AIRBAGs start to deflate immediately so that the driver's vision is not obstructed.

1 SRS AIRBAGs deploy as soon as a collision occurs.

2 After deployment, SRS AIRBAGs start to deflate immediately so that the driver's vision is not obstructed.

The SRS airbag can function only when the engine switch is in the “ON” position (vehicles without a smart entry & start system) or when the “ENGINE START STOP” switch is in IGNITION ON mode (vehicles with a smart entry & start system).

If the front sub sensors located on both the right and left sides at the front of the vehicle and the impact sensors in the airbag control module detect a certain predetermined amount of force during a front collision, the control module sends signals to the front airbag modules instructing them to inflate the SRS front airbags. Then both airbag modules produce gas, which instantly inflates driver’s and passenger’s SRS front airbags. The knee airbag is also inflated in combination with the SRS front airbags.

After deployment, the SRS airbags immediately start to deflate so that the driver’s vision is not obstructed. The time required from detecting impact to the deflation of the SRS airbag after deployment is shorter than the blink of an eye.

Although it is highly unlikely that the SRS airbag would activate in a non-accident situation, should it occur, the SRS airbag will deflate quickly, not obscuring vision and will not interfere with the driver’s ability to maintain control of the vehicle.

When the SRS airbag deploys, a sudden, fairly loud inflation noise will be heard and some smoke will be released. These occurrences are normal result of the deployment. This smoke does not indicate a fire in the vehicle.

The SRS front airbag (and also the knee airbag) is designed to deploy in the event of an accident involving a moderate to severe front collision. It is not designed to deploy in most lesser front impacts because the necessary protection can be achieved by the seat belt alone. Also, it is not designed to deploy in most side or rear impacts or in most roll-over accidents because deployment of the SRS front airbag would not help the occupant in those situations.

The SRS airbag is designed to function on a one-time-only basis.

SRS airbag deployment depends on the level of force experienced in the passenger compartment during a collision. That level differs from one type of collision to another, and it may have no bearing on the visible damage done to the vehicle itself.

■ **When will the SRS front airbag most likely deploy?**

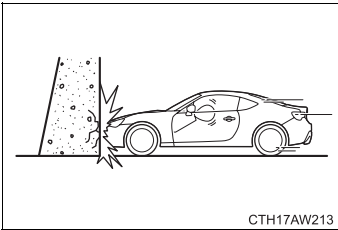

A head-on collision against a thick concrete wall at a vehicle speeds of 20 to 30 km/h (12 to 19 mph) or higher activates the SRS front airbag. The SRS front airbag will also be activated when the vehicle is exposed to a front impact similar in fashion and magnitude to the collision described above.

■ **At what other times might the SRS front airbag deploy?**

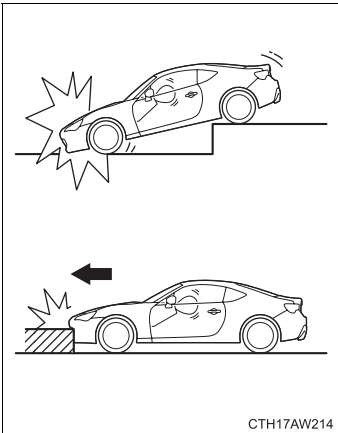

The SRS front airbag may be activated when the vehicle sustains a hard impact in the undercarriage area from the road surface (such as when the vehicle plunges into a deep ditch, is severely impacted or knocked hard against an obstacle on the road such as a curb).

■ When is the SRS front airbag unlikely to deploy?

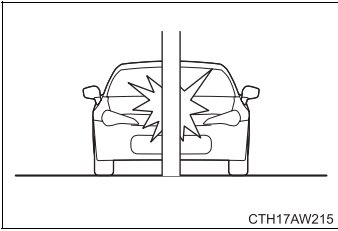

The vehicle strikes an object, such as a telephone pole or sign pole.

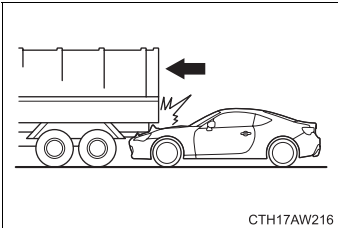

The vehicle slides under the load bed of a truck.

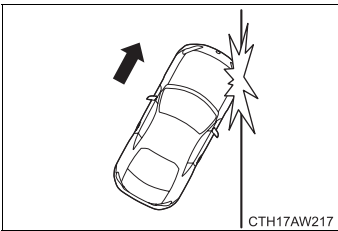

The vehicle sustains an oblique offset front impact.

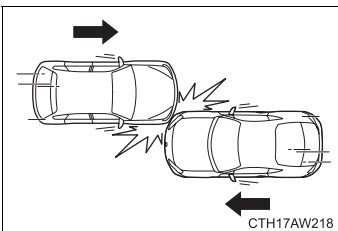

The vehicle sustains an offset front collision.

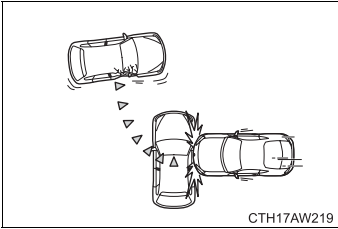

The vehicle strikes an object that can move or deform, such as a parked vehicle.

There are many types of collisions which might not necessarily require SRS front airbag deployment. In the event of accidents like those illustrated, the SRS front airbag may not deploy depending on the level of accident forces involved.

■ **When will the SRS front airbag not deploy?**

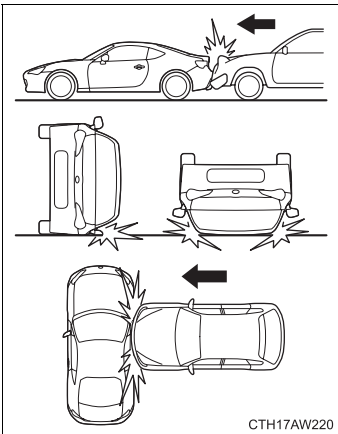

The SRS front airbag is not designed to deploy in most cases if the vehicle is struck from the side or from behind, or if it rolls onto its side or roof, or if it is involved in a low-speed front collision.

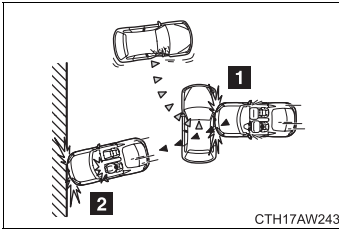

1 First impact

2 Second impact

In an accident where the vehicle is impacted more than once, the SRS front airbag deploys only once on the first impact.

Example: In the case of a double collision, first with another vehicle, then against a concrete wall in immediate succession, once the SRS front airbag is activated on the first impact, it will not be activated on the second.

CAUTION

SRS front airbag precaution

Do not touch the SRS airbag system components around the steering wheel and dashboard with bare hands right after deployment. Doing so can cause burns because the components can be very hot as a result of deployment.

SRS side airbag and SRS curtain shield airbag

The SRS side airbag is stored in the door side of each front seat seatback, which bears an “SRS AIRBAG” label.

In a moderate to severe side impact collision, the SRS side airbag on the impacted side of the vehicle deploys between the occupant and the door panel and supplements the seat belt by reducing the impact on the occupant’s chest.

The curtain shield airbag on each side of the cabin is stored in the roof side (between the front pillar and a point over the rear seat). An “SRS AIRBAG” mark is located at the top of each front and rear pillar.

In a moderate to severe side impact collision, the SRS curtain shield airbag on the impacted side of the vehicle deploys between the occupant and the side window and supplements the seat belt by reducing the impact on the occupant’s head.

■ Operation

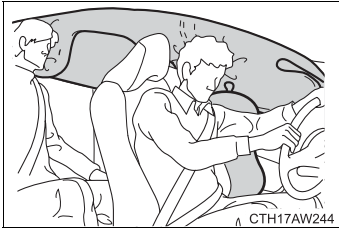

The SRS side airbag and SRS curtain shield airbag can function only when the engine switch is in the “ON” position (vehicles without a smart entry & start system) or when the “ENGINE START STOP” switch is in IGNITION ON mode (vehicles with a smart entry & start system).

The driver's and front passenger's SRS side airbags and SRS curtain shield airbags deploy independently of each other since each has its own impact sensor. Therefore, they may not both deploy in the same accident. Also, the SRS side airbag and SRS curtain shield airbag deploy independently of the driver's and front passenger's SRS front airbags in the steering wheel and instrument panel.

An impact sensor, which senses impact force, is located in each of the left and right center pillars, doors and rear wheel houses. Another impact sensor, which also senses impact force, is located under the rear center seat.

If one of the center pillar impact sensors and the impact sensor that is located under the rear center seat together sense an impact force above a predetermined level in a side collision, the control module causes both the SRS side airbag and SRS curtain shield airbag on the impacted side to inflate regardless of whether the rear wheel house impact sensor on the same side senses an impact.

If one of the rear wheel house impact sensors and the impact sensor that is located under the rear center seat together sense an impact force above a predetermined level in a side collision, the control module causes only the SRS curtain shield airbag on the impacted side to inflate.

After the deployment, the SRS side airbag immediately starts to deflate. The time required from detection of an impact to deflation of an SRS side airbag after deployment is shorter than the blink of an eye. The SRS curtain shield airbag remains inflated for a while following deployment then slowly deflates.

The SRS side airbag and SRS curtain shield airbag deploy even when no one occupies the seat on the side on which an impact is applied.

When the SRS side airbag and SRS curtain shield airbag deploy, a sudden, fairly loud inflation noise will be heard and some smoke will be released. These occurrences are a normal result of the deployment. This smoke does not indicate a fire in the vehicle.

The SRS side airbag and SRS curtain shield airbag are designed to deploy in the event of an accident involving a moderate to severe side impact collision. They are not designed to deploy in most lesser side impact. Also, they are not designed to deploy in most front or most rear impacts because SRS side airbag and SRS curtain shield airbag deployment would not help the occupant in those situations.

Each SRS side airbag and SRS curtain shield airbag are designed to function on a onetime-only basis.

SRS side airbag and SRS curtain shield airbag deployment depend on the level of force experienced in the passenger compartment during a side impact collision. That level differs from one type of collision to another, and it may have no bearing on the visible damage done to the vehicle itself.

■ **When will the SRS side airbag and SRS curtain shield airbag most likely deploy?**

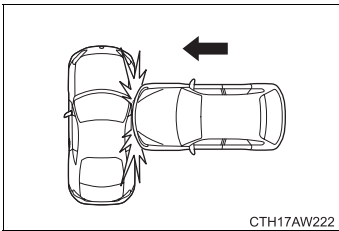

A severe side impact near the front seat activates the SRS side airbag and SRS curtain shield airbag.

■ **When are the SRS side airbag and SRS curtain shield airbag unlikely to deploy?**

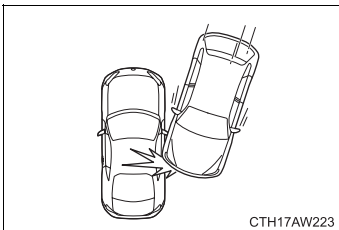

The vehicle is involved in an oblique side-on impact.

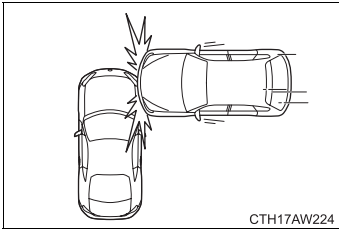

The vehicle is involved in a side-on impact in an area outside the vicinity of the passenger compartment.

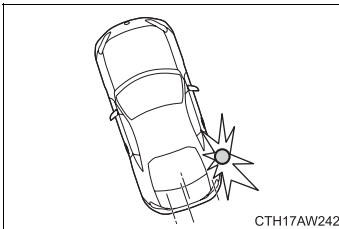

The vehicle strikes a telephone pole or similar object.

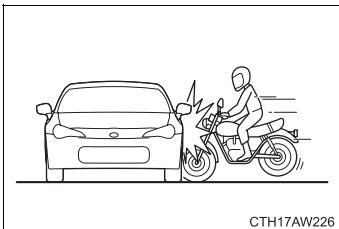

The vehicle is involved in a side-on impact from a motorcycle.

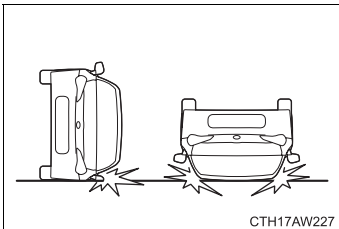

The vehicle rolls onto its side or roof.

There are many types of collisions which might not necessarily require SRS side airbag and SRS curtain shield airbag deployment. In the event of accidents like those illustrated, the SRS side airbag and SRS curtain shield airbag may not deploy depending on the level of accident forces involved.

■ When will the SRS side airbag and SRS curtain shield airbag not deploy?

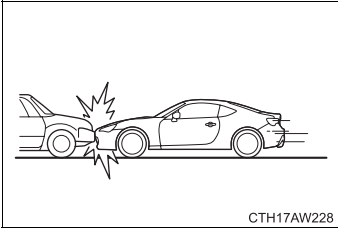

The vehicle is involved in front collision with another vehicle (moving or stationary).

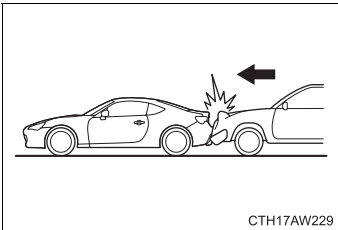

The vehicle is struck from behind.

The SRS side airbag and SRS curtain shield airbag are not designed to deploy in most cases if the vehicle is involved in a front collision or is struck from behind. Examples of such accidents are illustrated.

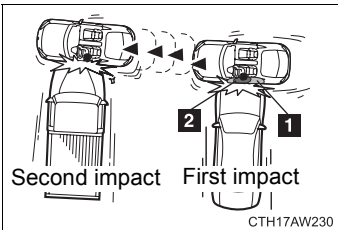

- 1 SRS curtain shield airbag
- 2 SRS side airbag

In an accident where the vehicle is struck from the side more than once, the SRS side airbag and SRS curtain shield airbag deploy only once on the first impact.

Example: In the case of a double side impact collision, first with one vehicle and immediately followed by another from the same direction, once the SRS side airbag and SRS curtain shield airbag are activated on the first impact, they will not be activated on the second.

■ When to contact any authorized Toyota dealer or repairer, or another duly qualified and equipped professional

In the following cases, the vehicle will require inspection and/or repair. Contact any authorized Toyota dealer or repairer, or another duly qualified and equipped professional as soon as possible.

- Any of the SRS airbags have been inflated.

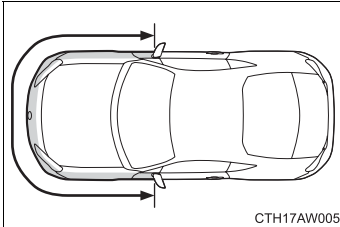

- The front of the vehicle is damaged or deformed, or was involved in an accident that was not severe enough to cause the SRS airbags to inflate.

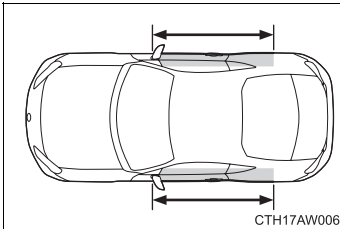

- A portion of a door is damaged or deformed, or the vehicle was involved in an accident that was not severe enough to cause the SRS side airbags and curtain shield airbags to inflate.

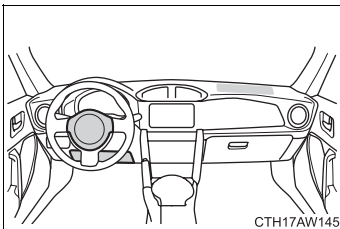

- The pad section of the steering wheel, dashboard or lower portion of the instrument panel is scratched, cracked, or otherwise damaged.

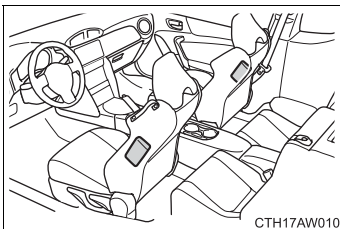

- The surface of the seats with the side airbag is scratched, cracked, or otherwise damaged.

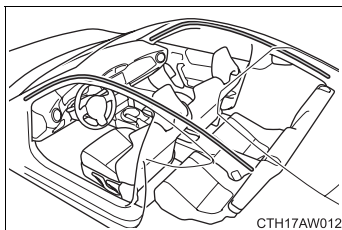

- The portion of the front pillars, rear pillars or roof side rail garnishes (padding) containing the curtain shield airbags inside is scratched, cracked or otherwise damaged.

⚠ CAUTION

■ If the SRS airbags deploy

Do not touch the SRS side airbag system components around the front seat seatback with bare hands right after deployment. Doing so can cause burns because the components can be very hot as a result of deployment.

After deployment, do not touch any part of the SRS curtain shield airbag system (from the front pillar to the part of the roof side over the rear seat). Doing so can cause burns because the components can be very hot as a result of deployment.

■ SRS airbag precautions

Observe the following precautions regarding the airbags. Failure to do so may cause death or serious injury.

- The driver and all passengers in the vehicle must wear their seat belts properly.
The SRS airbags are supplemental devices to be used with the seat belts.
- The SRS driver airbag deploys with considerable force, and can cause death or serious injury especially if the driver is very close to the airbag.

Since the risk zone for driver airbag is the first 50 - 75 mm (2 - 3 in.) of inflation, placing yourself 250 mm (10 in.) from your driver airbag provides you with a clear margin of safety. This distance is measured from the center of the steering wheel to your breastbone. If you sit less than 250 mm (10 in.) away now, you can change your driving position in several ways:

- Move your seat to the rear as far as you can while still reaching the pedals comfortably.

⚠ CAUTION

■ SRS airbag precautions

- Slightly recline the back of the seat. Although vehicle designs vary, many drivers can achieve the 250 mm (10 in.) distance, even with the driver seat all the way forward, simply by reclining the back of the seat somewhat. If reclining the back of your seat makes it hard to see the road, raise yourself by using a firm, non-slippery cushion, or raise the seat if your vehicle has that feature.
- If your steering wheel is adjustable, tilt it downward. This points the airbag toward your chest instead of your head and neck.

The seat should be adjusted as recommended above, while still maintaining control of the foot pedals, steering wheel, and your view of the instrument panel controls.

- The SRS front passenger airbag also deploys with considerable force, and can cause death or serious injury especially if the front passenger is very close to the airbag. The front passenger seat should be as far from the airbag as possible with the seatback adjusted, so the front passenger sits upright.
- Improperly seated and/or restrained infants and children can be killed or seriously injured by a deploying airbag. An infant or child who is too small to use a seat belt should be properly secured using a child restraint system. Toyota strongly recommends that all infants and children be placed in the rear seats of the vehicle and properly restrained. The rear seats are safer for infants and children than the front passenger seat. (→P. 134)

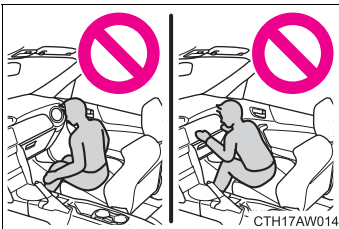

- Do not sit on the edge of the seat or lean against the dashboard.

⚠ CAUTION

■ SRS airbag precautions

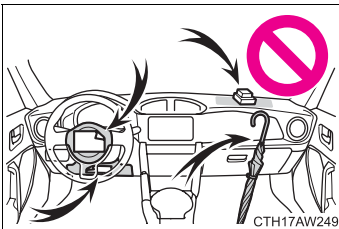
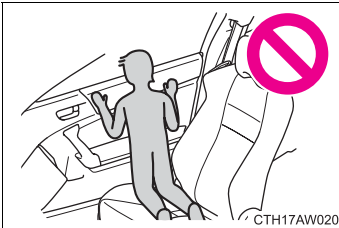
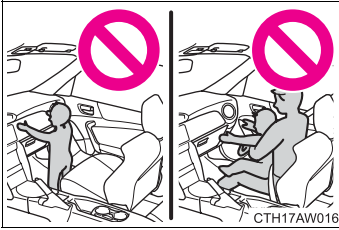

- Do not allow a child to stand in front of the SRS front passenger airbag unit or sit on the knees of a front passenger.
- Do not allow the front seat occupants to hold items on their knees.
- Do not lean against the door, the roof side rail or the front, side and rear pillars.
- Do not allow anyone to kneel on the passenger seat toward the door or put their head or hands outside the vehicle.
- Do not attach anything to or lean anything against areas such as the dashboard, steering wheel pad or lower portion of the instrument panel. These items can become projectiles when SRS driver, front passenger and knee airbags deploy.

⚠ CAUTION

■ SRS airbag precautions

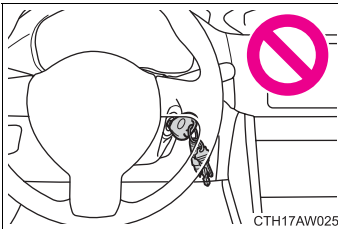
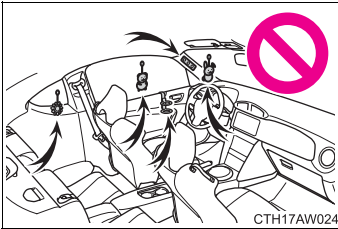

- Do not attach anything to areas such as a door, windshield glass, side door glass, rear quarter glass, front or rear pillar, roof side rail and assist grip. (Except for the speed limit label →P. 399)
- Vehicles without a smart entry & start system only: Do not attach any heavy, sharp or hard objects such as keys and accessories to the key. The objects may restrict the SRS knee airbag inflation or be thrust into the driver's seat area by the force of the deploying airbag, thus causing a danger.
- If the vinyl cover is put on the area where the SRS knee airbag will deploy, be sure to remove it.
- Do not use seat accessories which cover the parts where the SRS side airbags inflate as they may interfere with inflation of the airbags. Such accessories may prevent the side airbags from activating correctly, disable the system or cause the side airbags to inflate accidentally, resulting in death or serious injury.
- Do not strike or apply significant levels of force to the area of the SRS airbag components (→P. 110). Doing so can cause the SRS airbags to malfunction.
- Do not touch any of the component parts immediately after the SRS airbags have deployed (inflated) as they may be hot.
- If breathing becomes difficult after the SRS airbag has deployed, open a door or window to allow fresh air in, or leave the vehicle if it is safe to do so. Wash off any residue as soon as possible to prevent skin irritation.

 CAUTION

■ **SRS airbag precautions**

- If the areas where the SRS airbags are stored, such as the steering wheel pad and front and rear pillar garnishes, are damaged or cracked, have them replaced by any authorized Toyota dealer or repairer, or another duly qualified and equipped professional.
- The SRS side airbag and SRS curtain shield airbag are designed only to be a supplement to the primary protection provided by the seat belt. They do not do away with the need to fasten seat belts. It is also important to wear your seat belt to help avoid injuries that can result when an occupant is not seated in a proper upright position.

■ **Modification and disposal of SRS airbag system components**

Do not dispose of your vehicle or perform any of the following modifications without consulting any authorized Toyota dealer or repairer, or another duly qualified and equipped professional.

The SRS airbags may malfunction or deploy (inflate) accidentally, causing death or serious injury.

- Installation, removal, disassembly and repair of the SRS airbags.
- Repairs, modifications, removal or replacement of the steering wheel, instrument panel, dashboard, seats or seat upholstery, front, side and rear pillars or roof side rails.
- Repairs or modifications of the front fender, front bumper, or side of the occupant compartment.
- Installation of a grille guard (bull bars, kangaroo bar, etc.), snow plows, winches.
- Modifications to the vehicle's suspension system.
- Installation of electronic devices such as mobile two-way radios and CD players.
- Installation of electronic devices such as an RF-transmitter and CD players.
- Modifications to your vehicle for a person with a physical disability.

SRS airbag system monitor

■ SRS warning light

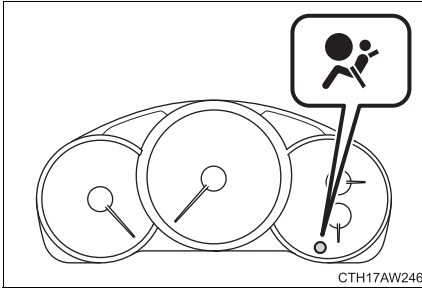

A diagnostic system continually monitors the readiness of the SRS airbag system (including front seat belt pretensioners) while the vehicle is being driven. The SRS warning light will show normal system operation by illuminating for approximately 6 seconds when the engine switch is turned to the “ON” position (vehicles without a smart entry & start system), or the “ENGINE START STOP” switch is turned to IGNITION ON mode (vehicles with a smart entry & start system).

The following components are monitored by the indicator.

- Front sub sensor
 - Right-hand side
 - Left-hand side
- Airbag control module (including impact sensor)
- Front airbag module
 - Driver’s side
 - Front passenger’s side
- Knee airbag module (driver’s side)

- Side airbag sensor
 - Center pillar right-hand side
 - Center pillar left-hand side
- Side airbag module
 - Driver's side
 - Front passenger's side
- Curtain shield airbag sensor
 - Rear wheel house right-hand side
 - Rear wheel house left-hand side
- Curtain shield airbag module
 - Right-hand side
 - Left-hand side
- Satellite safing sensor (under the center of the rear seats)
- Seat belt pretensioner
 - Driver's side
 - Front passenger's side
- All related wiring
- Door impact sensor
 - Right-hand side
 - Left-hand side
- Front passenger's front airbag cut off switch (passenger's side of instrument panel)
- Front passenger's front airbag ON and OFF indicator

 **CAUTION****■ SRS warning light**

If the warning light exhibits any of the following conditions, there may be a malfunction in the seat belt pretensioners and/or SRS airbag system. We recommend that you have the system checked immediately by your nearest any authorized Toyota dealer or repairer, or another duly qualified and equipped professional. Unless checked and properly repaired, the seat belt pretensioners and/or SRS airbags will operate improperly (e.g. SRS airbags may inflate in a very minor collision or not inflate in a severe collision), which may increase the risk of injury.

- Flashing or flickering of the warning light
- No illumination of the warning light when the engine switch is first turned to the “ON” position (vehicles without a smart entry & start system), or the “ENGINE START STOP” switch is turned to IGNITION ON mode (vehicles with a smart entry & start system).
- Continuous illumination of the warning light
- Illumination of the warning light while driving

1-7. Safety information

Child restraint systems

Toyota strongly urges the use of child restraint systems.

Points to remember

Studies have shown that installing a child restraint on a rear seat is safer than installing one to the front passenger seat.

- Choose a child restraint system appropriate to the age and size of the child.
- For installation details, follow the instructions provided with the child restraint system.
General installation instructions are provided in this manual.
(→P. 142)
- If child restraint system regulations exist in the country where you reside, please contact any authorized Toyota dealer or repairer, or another duly qualified and equipped professional for the child restraint system installation.
- Toyota recommends that you use a child restraint system which conforms to the regulation “ECE No.44”.

Types of child restraints

Child restraint systems are classified into the following 5 groups according to the regulation ECE No.44:

Group 0: Up to 10 kg (22 lb.) (0 - 9 months)

Group 0⁺: Up to 13 kg (28 lb.) (0 - 2 years)

Group I: 9 to 18 kg (20 to 39 lb.) (9 months - 4 years)

Group II: 15 to 25 kg (34 to 55 lb.) (4 years - 7 years)

Group III: 22 to 36 kg (49 to 79 lb.) (6 years - 12 years)

In this owner's manual, the following popular 3 types of child restraint systems that can be secured with the seat belts are explained.

Baby seat

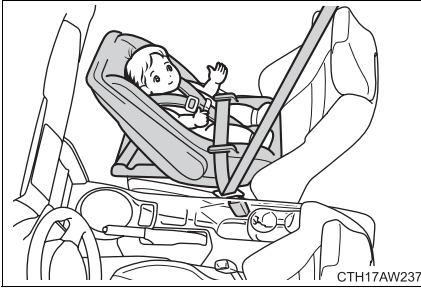

Equal to Group 0 and 0⁺ of ECE No.44

Child seat

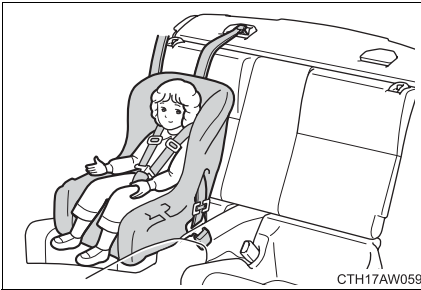

Equal to Group 0⁺ and I of ECE No.44

Junior seat

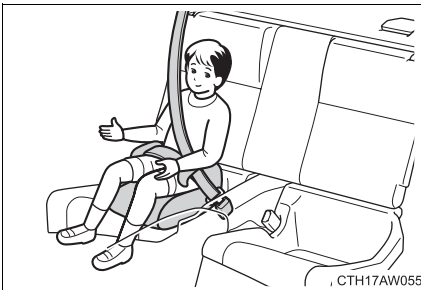

Equal to Group II and III of ECE No.44

Child restraint system suitability for various seating positions

Provided information in the table shows your child restraint system suitability for various seating positions.

Seating position Mass groups	Front passenger seat		Rear seat
	Airbag manual on-off switch		
	ON	OFF	
0 (up to 10 kg [22 lb.])	X Never put	L3, L4	X
0+ (up to 13 kg [28 lb.])	X Never put	L3, L4	X
I (9 to 18 kg [20 to 39 lb.])	Rear-facing X Never put	L1	U
	Forward-facing L1		
II, III (15 to 36 kg [34 to 79 lb.])	L2, L5	L2, L5	U, L2

Note

When you use child restraint system on the front passenger seat, you must turn off the airbag manual on-off switch.

Key of letters inserted in the above table:

U: Suitable for “universal” category child restraint system approved for the use in this mass group.

L1: Suitable for “TOYOTA DUO+” (9 to 18 kg [20 to 39 lb.]) approved for the use in this mass group.

L2: Suitable for “TOYOTA KID FIX” (15 to 36 kg [34 to 79 lb.]) approved for the use in this mass group.

L3: Suitable for “TOYOTA G 0+,BABY SAFE PLUS” (up to 13 kg [28 lb.]) approved for the use in this mass group.

L4: Suitable for “TOYOTA G 0+,BABY SAFE PLUS with SEAT BELT FIXATION, BASE PLATFORM” (up to 13 kg [28 lb.]) approved for the use in this mass group.

L5: Suitable for “TOYOTA KID” (15 to 36 kg [34 to 79 lb.]) approved for the use in this mass group.

X: Not suitable seat position for children in this mass group.

The child restraint systems mentioned in the table may not be available outside of the EU area.

Other child restraint systems different from the systems mentioned in the table can be used, but the suitability of the systems must be carefully checked with the child restraint system manufacturer and retailer.

**Child restraint system suitability for various seating positions
(with ISOFIX rigid anchors)**

Provided information in the table shows your child restraint system suitability for various seating positions.

Mass groups	Size class	Fixture	Vehicle ISOFIX positions
			Rear seat
Carrycot	F	ISO/L1	X
	G	ISO/L2	X
		(1)	X
0 (up to 10 kg [22 lb.])	E	ISO/R1	X
		(1)	X
0+ (up to 13 kg [28 lb.])	E	ISO/R1	X
	D	ISO/R2	X
	C	ISO/R3	X
		(1)	X
I (9 to 18 kg [20 to 39 lb.])	D	ISO/R2	X
	C	ISO/R3	X
	B	ISO/F2	IUF
	B1	ISO/F2X	IUF
	A	ISO/F3	X
		(1)	X
II (15 to 25 kg [34 to 55 lb.])		(1)	X
III (22 to 36 kg [49 to 79 lb.])		(1)	X

- (1) For the CRS which do not carry the ISO/XX size class identification (A to G), for the applicable mass group, the car manufacturer shall indicate the vehicle specific ISOFIX child restraint system(s) recommended for each position.

Key of letters inserted in the above table:

IUF: Suitable for ISOFIX forward child restraint systems of universal category approved for use in this mass group.

X: ISOFIX position not suitable for ISOFIX child restraint systems in this mass group and/or this size class.

The child restraint systems mentioned in the table may not be available outside of the EU area.

Other child restraint systems different from the systems mentioned in the table can be used, but the suitability of the systems must be carefully checked with the child restraint system manufacturer and retailer.

■ When installing the child restraint system on the front passenger seat

When you have to use a child restraint system on the front passenger seat, adjust the following:

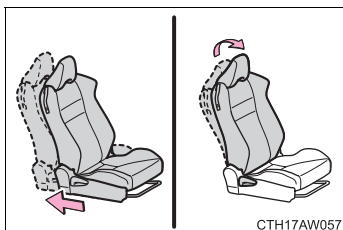

- The seat cushion to the fully rearward position
- The seatback to the most upright position

■ Selecting an appropriate child restraint system

- Use a child restraint system appropriate for the child until the child becomes large enough to properly wear the vehicle's seat belt.
- If a child is too large for a child restraint system, sit the child on a rear seat and use the vehicle's seat belt. (→P. 72)

⚠ CAUTION

■ Using a child restraint system

The use of a child restraint system not suitable for the vehicle may not properly secure the infant or child. It may result in death or serious injury (in the event of sudden braking or an accident).

■ Child restraint precautions

- For effective protection in automobile accidents and sudden stops, a child must be properly restrained, using a seat belt or child restraint system depending on the age and size of the child. Holding a child in your arms is not a substitute for a child restraint system. In an accident, the child can be crushed against the windshield, or between you and the vehicle's interior.
- Toyota strongly urges the use of a proper child restraint system that conforms to the size of the child, installed on the rear seat. According to accident statistics, the child is safer when properly restrained in the rear seat than in the front seat.

 **CAUTION****■ Child restraint precautions**

- Never use a rear-facing child restraint system on the front passenger seat when the airbag manual on-off switch is on. (→P. 152)
In the event of an accident, the force of the rapid inflation of the front passenger airbag can cause death or serious injury to the child.
- A forward-facing child restraint system should be allowed to be installed on the front passenger seat only when it is unavoidable. Always move the seat as far back as possible, because the front passenger airbag could inflate with considerable speed and force. Otherwise, the child may be killed or seriously injured.
- Do not allow the child to lean his/her head or any part of his/her body against the door or the area of the seat, front and rear pillars or roof side rails from which the SRS side airbags or SRS curtain shield airbags deploy even if the child is seated in the child restraint system. It is dangerous if the SRS side airbags and curtain shield airbags inflate, and the impact could cause death or serious injury to the child.
- Make sure you have complied with all installation instructions provided by the child restraint manufacturer and that the system is properly secured. If it is not secured properly, it may cause death or serious injury to the child in the event of a sudden stop, sudden swerve or an accident.

■ When children are in the vehicle

Do not allow children to play with the seat belt. If the seat belt becomes twisted around a child's neck, it may lead to choking or other serious injuries that could result in death.

If this occurs and the buckle cannot be unfastened, scissors should be used to cut the belt.

■ When the child restraint system is not in use

- Keep the child restraint system properly secured on the seat even if it is not in use. Do not store the restraint unsecured in the passenger compartment.
- If it is necessary to detach the child restraint system, remove it from the vehicle or store it securely in the trunk. This will prevent it from injuring passengers in the event of a sudden stop, sudden swerve or an accident.

1-7. Safety information

Installing child restraints

Follow the child restraint system manufacturer's instructions. Firmly secure child restraints to the rear seats using a seat belt or a ISOFIX rigid anchors. Attach the top strap when installing a child restraint.

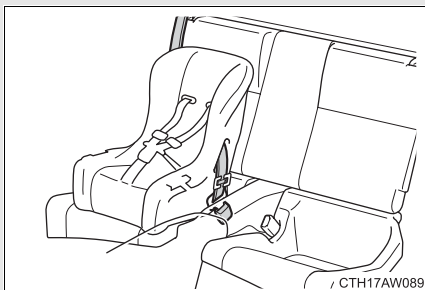

Installation with a seat belt
(→P. 143)

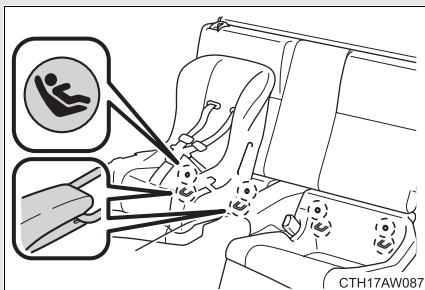

ISOFIX rigid anchors (ISOFIX child restraint system)

Lower anchors are provided for the both rear seats. (Buttons displaying the location of the anchors are attached to the seats.)

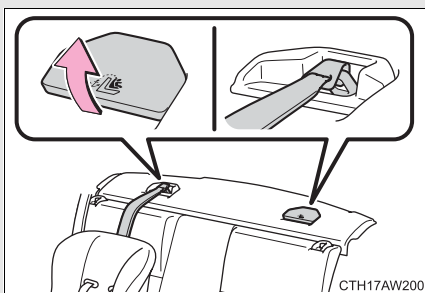

Anchor bracket (for top strap)

Anchor brackets are provided for both rear seats.

Installing child restraints using a seat belt

■ Rear facing — Baby seat/child seat

STEP 1

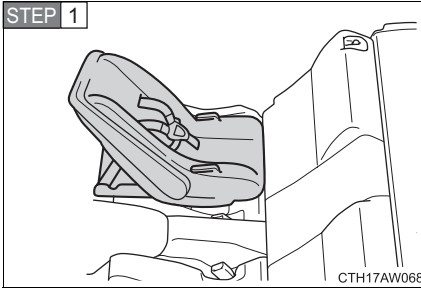

Place the child restraint system on the rear seat facing the rear of the vehicle.

STEP 2

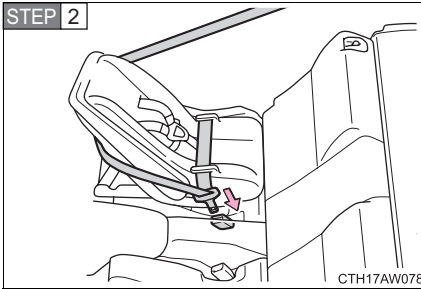

Run the seat belt through the child restraint system and insert the plate into the buckle. Make sure that the belt is not twisted.

Follow the directions given in the child restraint system installation manual and fix the child restraint system securely in place.

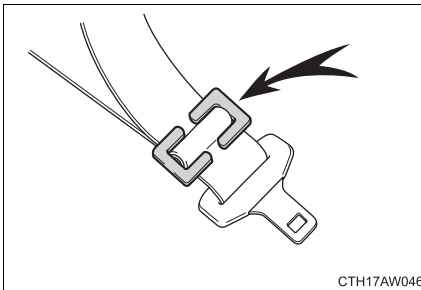

If your child restraint system is not equipped with a lock-off (a seat belt locking feature), secure the child restraint system using a locking clip.

After installing the child restraint system, rock it back and forth to ensure that it is installed securely.

■ Forward facing — Child seat

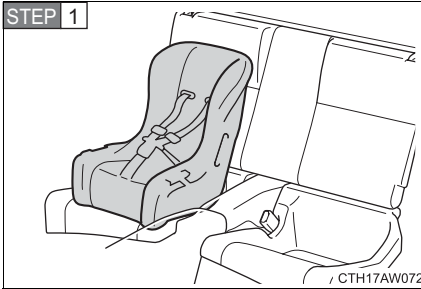

Place the child restraint system on the seat facing the front of the vehicle.

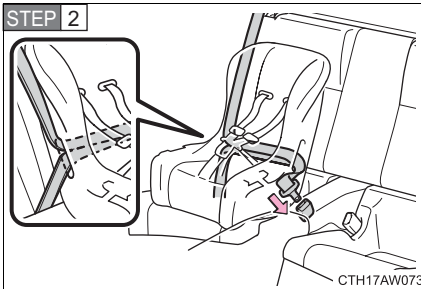

Run the seat belt through the child restraint system and insert the plate into the buckle. Make sure that the belt is not twisted.

Follow the directions given in the child restraint system installation manual and fix the child restraint system securely in place.

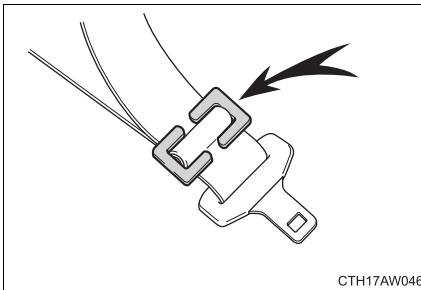

If your child restraint system is not equipped with a lock-off (a seat belt locking feature), secure the child restraint system using a locking clip.

After installing the child restraint system, rock it back and forth to ensure that it is installed securely.

■ Junior seat

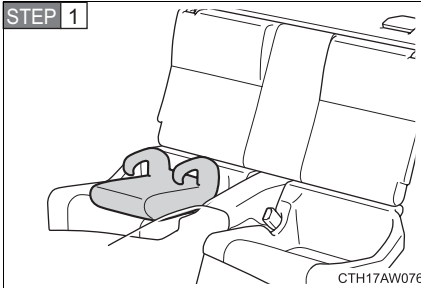

Place the child restraint system on the seat facing the front of the vehicle.

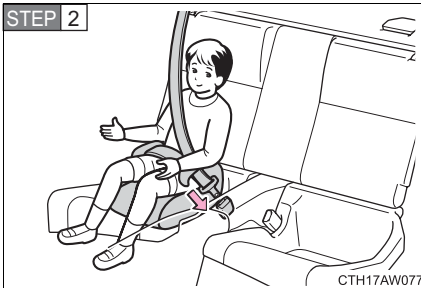

Sit the child in the child restraint system. Fit the seat belt to the child restraint system and insert the plate into the buckle. Make sure that the belt is not twisted.

Check that the shoulder belt is correctly positioned over the child's shoulder and that the lap belt is as low as possible.

(→P. 72)

Removing a child restraint installed with a seat belt

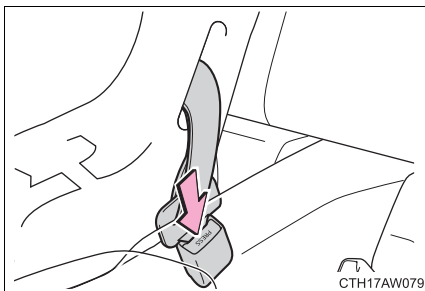

Push the buckle release button and fully retract the seat belt.

Installation with ISOFIX rigid anchor (ISOFIX child restraint system)

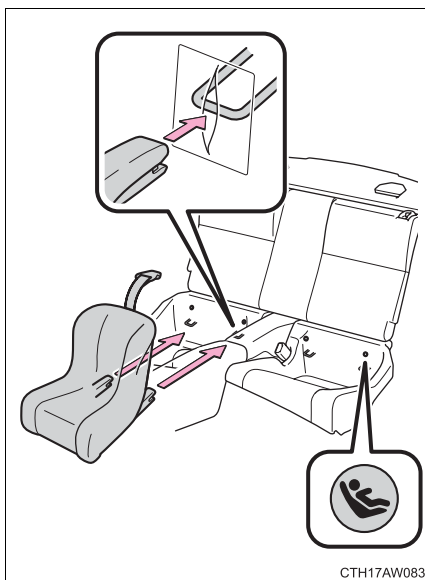

Latch the buckles onto the exclusive fixing bars.

If the child restraint has a top strap, the top strap should be latched onto the anchor bracket.

Child restraint systems with a top strap

STEP 1 Secure the child restraint using a seat belt or ISOFIX rigid anchor.

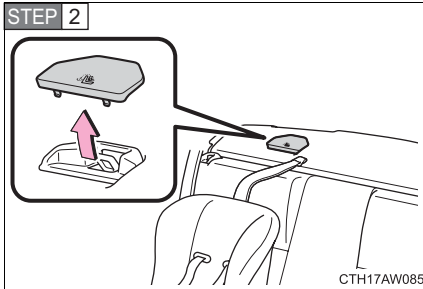

Remove the anchor bracket cover.

Store the removed cover in a safe place.

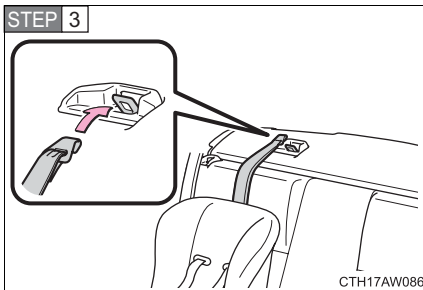

Latch the hook onto the anchor bracket and tighten the top strap.

Make sure the top strap is securely latched.

■ **When installing a child restraint system (without a lock-off) using a seat belt**

You need a locking clip to install the child restraint system using a seat belt. Follow the instructions provided by the manufacturer of the system. If your child restraint system does not provide a locking clip, you can purchase the following item from any authorized Toyota dealer or repairer, or another duly qualified and equipped professional.

Locking clip for child restraint system
(Part No. 73119-22010)

■ **When installing a child restraint system with ISOFIX rigid anchors and a top strap**

Depending on the child restraint system's size and shape, if the child restraint system is installed to the fixing bars first, it may not be possible to attach the top strap to the anchor bracket.

In that case, first temporarily attach the top strap to the anchor bracket, install the child restraint system using the ISOFIX rigid anchors and then tighten the top strap.

⚠ CAUTION

■ When installing a child restraint system

Follow the directions given in the child restraint system installation manual and fix the child restraint system securely in place.

If the child restraint system is not correctly fixed in place, the child or other passengers may be injured or even killed in the event of sudden braking, sudden swerving or an accident.

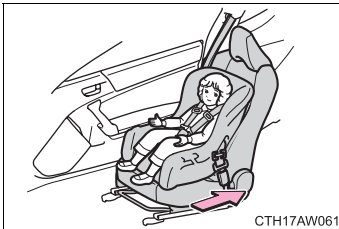

- If the driver's seat interferes with the child restraint system and prevents it from being attached correctly, attach the child restraint system to the right-hand rear seat (left-hand drive vehicles) or the left-hand rear seat (right-hand drive vehicles).
- Adjust the front passenger seat so that it does not interfere with the child restraint system.
- When installing a forward-facing child restraint system on the front passenger seat, move the seat as far back as possible. Failure to do so may result in death or serious injury if the airbags deploy (inflate).

⚠ CAUTION

■ When installing a child restraint system

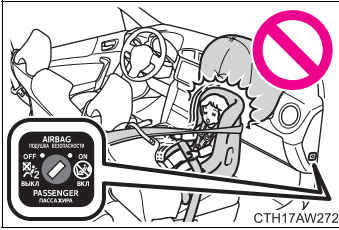

- Never use a rear-facing child restraint system on the front passenger seat when the airbag manual on-off switch is on. (→P. 152)

The force of the rapid inflation of the front passenger airbag can cause death or serious injury to children in the event of an accident.

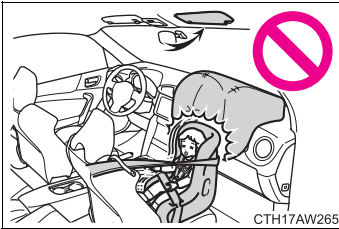

- There is a label(s) on the passenger side sun visor, indicating it is forbidden to attach a rear-facing child restraint system to the front passenger seat.

Details of the label(s) are shown in the illustration below.



CTH17AW268

 **CAUTION****■ When installing a child restraint system**

- If child restraint system regulations exist in the country where you reside, please contact any authorized Toyota dealer or repairer, or another duly qualified and equipped professional for the child restraint system installation.
- When a junior seat is installed, always ensure that the shoulder belt is positioned across the center of the child's shoulder. The belt should be kept away from the child's neck, but not so that it could fall off the child's shoulder. Failure to do so may result in death or serious injury in the event of sudden braking, sudden swerving or an accident.
- Do not allow children to play with the seat belt. If the seat belt becomes twisted around a child's neck, choking or other serious injuries may result in death.
If this occurs and the buckle cannot be unfastened, scissors should be used to cut the belt.
- Ensure that the belt and plate are securely locked and the seat belt is not twisted.
- Shake the child restraint system left and right, and forward and backward to ensure that it has been securely installed.
- After securing a child restraint system, never adjust the seat.
- Follow all installation instructions provided by the child restraint system manufacturer.

■ To correctly attach a child restraint system to the anchors

When using the lower anchors, be sure that there are no foreign objects around the anchors and that the seat belt is not caught behind the child restraint system. Make sure the child restraint system is securely attached, or it may cause death or serious injury to the child or other passengers in the event of sudden braking, sudden swerve or an accident.

1-7. Safety information

Airbag manual on-off system

This system deactivates the front passenger airbag.

Only deactivate the airbags when using a child restraint system on the front passenger seat.

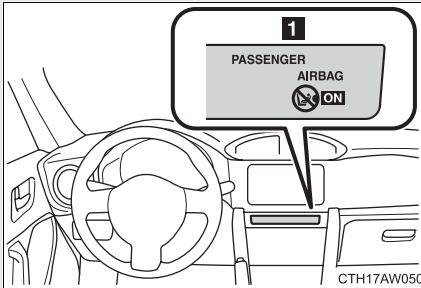

1 Airbag manual on-off indicator

Vehicles without a smart entry & start system

This indicator light turns on when the airbag system is on (only when the engine switch is in the "ON" position).

Vehicles with a smart entry & start system

This indicator light turns on when the airbag system is on (only when the "ENGINE START STOP" switch is in IGNITION ON mode).

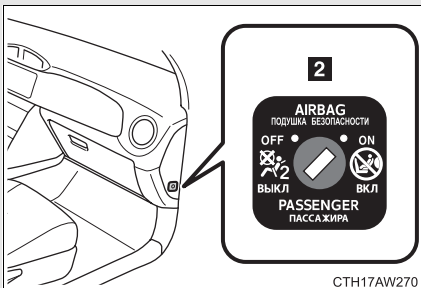

2 Airbag manual on-off switch

Deactivating the front passenger airbag

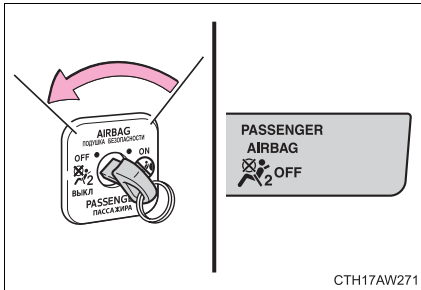

Vehicles without a smart entry & start system

Insert the key into the cylinder and turn to the “OFF” position.

The “OFF” indicator light turns on (only when the engine switch is in the “ON” position).

Vehicles with a smart entry & start system

Insert the mechanical key into the cylinder and rotate to the “OFF” position.

The “OFF” indicator light turns on (only when the “ENGINE START STOP” switch is in IGNITION ON mode).

■ Airbag manual on-off indicator information

- The front passenger's front airbag ON and OFF indicators shows you the status of the front passenger's SRS front airbag. When the engine switch is turned to the "ON" position (vehicles without a smart entry & start system) or the "ENGINE START STOP" switch is turned to IGNITION ON mode (vehicles with a smart entry & start system), both the ON and OFF indicators illuminate while the system is checked, after which both indicators turn off. After that, "ON" or "OFF" on the ON-OFF indicator will be illuminated according to the position of the airbag manual on-off switch.
- If any of the following problems occur, it is possible that there is a malfunction in the system. Have the vehicle inspected by any authorized Toyota dealer or repairer, or another duly qualified and equipped professional.
 - Neither "ON" nor "OFF" comes on.
 - The indicator light does not change when the airbag manual on-off switch is switched to "ON" or "OFF".

CAUTION

■ When installing a child restraint system

For safety reasons, always install a child restraint system in a rear seat. In the event that the rear seat cannot be used, the front seat can be used as long as the airbag manual on-off system is set to "OFF".

If the airbag manual on-off system is left on, the strong impact of the airbag deployment (inflation) may cause serious injury or even death.

■ When a child restraint system is not installed on the front passenger seat

Ensure that the airbag manual on-off system is set to "ON".

If it is left off, the airbag may not deploy in the event of an accident, which may result in serious injury or even death.

When driving

2

2-1. Driving procedures

Driving the vehicle	156
Engine (ignition) switch (vehicles with a smart entry & start system).....	169
Engine (ignition) switch (vehicles without a smart entry & start system).....	178
Automatic transmission	181
Manual Transmission	188
Turn signal lever	191
Parking brake	192
Horn.....	193

2-2. Instrument cluster

Gauges and meters	194
Indicators and warning lights	198
Multi-information display	203

2-3. Operating the lights and windshield wipers

Headlight switch.....	208
Fog light switch	215
Windshield wipers and washer	217

2-4. Using other driving systems

Cruise control.....	220
Driving assist systems	225

2-5. Driving information

Cargo and luggage	231
Winter driving tips	233
Trailer towing	237

Driving the vehicle

The following procedures should be observed to ensure safe driving:

■ Starting the engine

→P. 169, 178

■ Driving

Vehicles with an automatic transmission

STEP 1 With the brake pedal depressed, shift the shift lever to D.
(→P. 181)

STEP 2 Release the parking brake. (→P. 192)

STEP 3 Gradually release the brake pedal and gently depress the accelerator pedal to accelerate the vehicle.

Vehicles with a manual transmission

STEP 1 While depressing the clutch pedal, shift the shift lever to 1.
(→P. 188)

STEP 2 Release the parking brake. (→P. 192)

STEP 3 Gradually release the clutch pedal. At the same time, gently depress the accelerator pedal to accelerate the vehicle.

■ Stopping

Vehicles with an automatic transmission

STEP 1 With the shift lever in D, depress the brake pedal.

STEP 2 If necessary, set the parking brake.

If the vehicle is to be stopped for an extended period of time, shift the shift lever to P or N. (→P. 181)

Vehicles with a manual transmission

STEP 1 While depressing the clutch pedal, depress the brake pedal.

STEP 2 If necessary, set the parking brake.

If the vehicle is to be stopped for an extended period of time, shift the shift lever to N. (→P. 188)

■ Parking the vehicle

Vehicles with an automatic transmission

STEP 1 With the shift lever in D, depress the brake pedal.

STEP 2 Shift the shift lever to P. (→P. 181)

STEP 3 Set the parking brake. (→P. 192)

STEP 4 Vehicles without a smart entry & start system:

Turn the engine switch to the “LOCK” position to stop the engine.

Vehicles with a smart entry & start system:

Press the “ENGINE START STOP” switch to stop the engine.

STEP 5 Lock the door, making sure that you have the key on your person.

If parking on a hill, block the wheels as needed.

Vehicles with a manual transmission

STEP 1 While depressing the clutch pedal, depress the brake pedal.

STEP 2 Shift the shift lever to N. (→P. 188)

STEP 3 Set the parking brake. (→P. 192)

STEP 4 Vehicles without a smart entry & start system:

Turn the engine switch to the “LOCK” position to stop the engine.

Vehicles with a smart entry & start system:

Press the “ENGINE START STOP” switch to stop the engine.

STEP 5 Lock the door, making sure that you have the key on your person.

If parking on a hill, shift the shift lever to 1 or R and block the wheels as needed.

Starting off on a steep uphill

Vehicles with an automatic transmission

- STEP 1** Make sure that the parking brake is set and shift the shift lever to D.
- STEP 2** Gently depress the accelerator pedal.
- STEP 3** Release the parking brake.

Vehicles with a manual transmission

- STEP 1** With the parking brake firmly set and the clutch pedal fully depressed, shift the shift lever to 1.
 - STEP 2** Lightly depress the accelerator pedal at the same time as gradually releasing the clutch pedal.
 - STEP 3** Release the parking brake.
-

Driving in the rain

- Drive carefully when it is raining, because visibility will be reduced, the windows may become fogged-up, and the road will be slippery.
- Drive carefully when it starts to rain, because the road surface will be especially slippery.
- Refrain from high speeds when driving on an expressway in the rain, because there may be a layer of water between the tires and the road surface, preventing the steering and brakes from operating properly.

Engine speed while driving (vehicles with an automatic transmission)

In the following conditions, the engine speed may become high while driving. This is due to automatic up-shifting control or down-shifting implementation to meet driving conditions. It does not indicate sudden acceleration.

- The vehicle is judged to be driving uphill or downhill
- When the accelerator pedal is released
- When driving on curves
- When the brake pedal is firmly depressed

■ New vehicle break-in driving (the first 1600 km [1000 miles])

The performance and long life of your vehicle are dependent on how you handle and care for your vehicle while it is new. Follow these instructions during the first 1600 km (1000 miles):

- Do not allow the engine speed to exceed 4000 rpm except in an emergency.
- Do not drive at one constant engine or vehicle speed for a long time, either fast or slow.
- Avoid starting suddenly and rapid acceleration, except in an emergency.
- Avoid hard braking, except in an emergency.

The same break-in procedures should be applied to an overhauled engine, newly mounted engine or when brake pads or brake linings are replaced with new ones.

■ Drum-in-disc type parking brake system

Your vehicle has a drum-in-disc type parking brake system. This type of brake system needs bedding-down of the brake shoes periodically or whenever the parking brake shoes and/or drum are replaced. Have any authorized Toyota dealer or repairer, or another duly qualified and equipped professional perform the bedding down.

■ After the engine starts

In order to secure a rich exhaust sound when starting the vehicle and environmental performance, air intake and exhaust sounds become loud and vibrations may increase for a little while after the engine starts. This is not a malfunction.

■ Operating your vehicle in a foreign country

Comply with the relevant vehicle registration laws and confirm the availability of the correct fuel. (→P. 437)

■ REV indicator (if equipped)

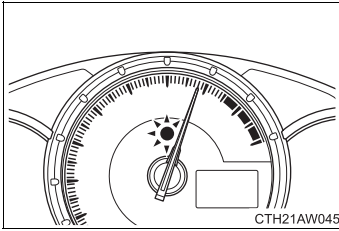

When the set engine speed is reached the REV indicator comes on and a buzzer sounds to inform the driver. (→P. 205)

(When the engine speed enters the red zone, the REV indicator flashes regardless of settings.)

⚠ CAUTION

■ When starting the vehicle (vehicles with an automatic transmission)

- Always keep your foot on the brake pedal while stopped with the engine running. This prevents the vehicle from creeping.
- Firmly depress the brake pedal because engine speed may increase immediately after starting the engine, when the air conditioning system is operating, when turning the steering wheel, etc., thereby causing creeping to become stronger. Apply the parking brake as necessary.

■ When driving the vehicle

- Do not drive if you are unfamiliar with the location of the brake and accelerator pedals to avoid depressing the wrong pedal.
 - Accidentally depressing the accelerator pedal instead of the brake pedal will result in sudden acceleration that may lead to an accident that could result in death or serious injury.
 - When backing up, you may twist your body around, leading to a difficulty in operating the pedals. Make sure to operate the pedals properly.
 - Make sure to keep a correct driving posture even when moving the vehicle only slightly. This allows you to depress the brake and accelerator pedals properly.
 - Depress the brake pedal using your right foot. Depressing the brake pedal using your left foot may delay response in an emergency, resulting in an accident.
- Do not drive the vehicle over or stop the vehicle near flammable materials. The exhaust system and exhaust gases can be extremely hot. These hot parts may cause a fire if there is any flammable material nearby.

 CAUTION

- On vehicles with an automatic transmission, do not let the vehicle roll backward while the shift lever is in a driving position, or roll forward while the shift lever is in R.
Doing so may cause the engine to stall or lead to poor brake and steering performance, resulting in an accident or damage to the vehicle.
- If the smell of exhaust is noticed inside the vehicle, open the windows and check that the trunk is closed. Large amounts of exhaust in the vehicle can cause driver drowsiness and an accident, resulting in death or a serious health hazard. Have the vehicle inspected by any authorized Toyota dealer or repairer, or another duly qualified and equipped professional immediately.
- On vehicles with a manual transmission, do not shift the shift lever to R while the vehicle is moving forward.
Doing so can damage the transmission and may result in a loss of vehicle control.
- Do not shift the shift lever to a driving position while the vehicle is moving backward.
Doing so can damage the transmission and may result in a loss of vehicle control.
- On vehicles with a manual transmission, do not release the clutch pedal too quickly. Doing so may propel the vehicle forward, possibly causing an accident.
- Moving the shift lever to N while the vehicle is moving will disengage the engine from the transmission. Engine braking is not available when N is selected.
- During normal driving, do not turn off the engine. Turning the engine off while driving will not cause loss of steering or braking control, but the power assist to these systems will be lost. This will make it more difficult to steer and brake, so you should pull over and stop the vehicle as soon as it is safe to do so.
However, in the event of an emergency, such as if it becomes impossible to stop the vehicle in the normal way: →P. 430

 **CAUTION**

- Use engine braking (downshift) to maintain a safe speed when driving down a steep hill.
Using the brakes continuously may cause the brakes to overheat and lose effectiveness. (→P. 182, 188)
- Do not adjust the position of the steering wheel, the seat, or the inside or outside rear view mirrors while driving.
Doing so may result in a loss of vehicle control that can cause accidents, resulting in death or serious injury.
- Always check that all passengers' arms, heads or other parts of their body are not outside the vehicle, as this may result in death or serious injury.

■ **When driving on slippery road surfaces**

- Sudden braking, acceleration and steering may cause tire slippage and reduce your ability to control the vehicle, resulting in an accident.
- Sudden acceleration, engine braking due to shifting, or changes in engine speed could cause the vehicle to skid, resulting in an accident.
- After driving through a puddle, lightly depress the brake pedal to make sure that the brakes are functioning properly. Wet brake pads may prevent the brakes from functioning properly. If the brakes on only one side are wet and not functioning properly, steering control may be affected, resulting in an accident.

■ **When shifting the shift lever**

- On vehicles with an automatic transmission, be careful not to shift the shift lever with the accelerator pedal depressed. Shifting the shift lever to a gear other than P or N may lead to unexpected rapid acceleration of the vehicle that may cause an accident and result in death or serious injury.
- Do not place items in the shift lever's surrounding area. It may cause incorrect operation.
- If the shift boot is pulled out during cleaning, return it to its previous position. If the shift boot is left pulled out, the shift lever may become difficult to operate.

 **CAUTION****■ If you hear a squealing or scraping noise (brake pad wear indicators)**

Have the brake pads checked and replaced by any authorized Toyota dealer or repairer, or another duly qualified and equipped professional as soon as possible.

Rotor damage may result if the pads are not replaced when needed.

It is dangerous to drive the vehicle when the wear limits of the brake pads and/or those of the brake discs are exceeded.

■ When the vehicle is stopped**● Do not race the engine.**

If the vehicle is in any gear other than P (vehicles with an automatic transmission only) or N, the vehicle may accelerate suddenly and unexpectedly, causing an accident.

● Do not leave the vehicle with the engine running for a long time.

If such a situation cannot be avoided, park the vehicle in an open space and check that exhaust fumes do not enter the vehicle interior.

● On vehicles with an automatic transmission, in order to prevent accidents due to the vehicle rolling away, always keep depressing the brake pedal while the engine is running, and apply the parking brake as necessary.**● If the vehicle is stopped on an incline, in order to prevent accidents caused by the vehicle rolling forward or backward, always depress the brake pedal and securely apply the parking brake as needed.****● Avoid revving or racing the engine.**

Running the engine at high speed while the vehicle is stopped may cause the exhaust system to overheat, which could result in a fire if combustible material is nearby.



CAUTION

■ When the vehicle is parked

- Do not leave glasses, cigarette lighters, spray cans, or soft drink cans in the vehicle when it is in the sun.
Doing so may result in the following:
 - Gas may leak from a cigarette lighter or spray can, and may lead to a fire.
 - The temperature inside the vehicle may cause the plastic lenses and plastic material of glasses to deform or crack.
 - Soft drink cans may fracture, causing the contents to spray over the interior of the vehicle, and may also cause a short circuit in the vehicle's electrical components.
- Do not leave cigarette lighters in the vehicle. If a cigarette lighter is in a place such as the glove box or on the floor, it may be lit accidentally when luggage is loaded or the seat is adjusted, causing a fire.
- Do not attach suction cups to the windshield or windows. Do not place containers such as air fresheners on the instrument panel or dashboard. Suction cups or containers may act as lenses, causing a fire in the vehicle.
- Do not leave a door or window open if the curved glass is coated with a metallized film such as a silver-colored one. Reflected sunlight may cause the glass to act as a lens, causing a fire.
- Always apply the parking brake, shift the shift lever to P (vehicles with an automatic transmission only), stop the engine and lock the vehicle.
Do not leave the vehicle unattended while the engine is running.
- Do not touch the exhaust pipe while the engine is running or immediately after turning the engine off.
Doing so may cause burns.
- Do not leave the engine running in an area with snow build-up, or where it is snowing. If snowbanks build up around the vehicle while the engine is running, exhaust gases may collect and enter the vehicle. This may lead to death or a serious health hazard.

 **CAUTION****Exhaust gases**

Exhaust gases include harmful carbon monoxide (CO), which is colorless and odorless. Inhaling exhaust gases may lead to death or a serious health hazard.

- If the vehicle is in a poorly ventilated area, stop the engine. In a closed area, such as a garage, exhaust gases may collect and enter the vehicle. This may lead to death or a serious health hazard.
- The exhaust system should be checked occasionally. If there is a hole or crack caused by corrosion, damage to a joint or abnormal exhaust noise, be sure to have the vehicle inspected and repaired by any authorized Toyota dealer or repairer, or another duly qualified and equipped professional. Failure to do so may allow exhaust gases to enter the vehicle, resulting in death or a serious health hazard.

When taking a nap in the vehicle

Always turn the engine off. Otherwise, you may accidentally move the shift lever or depress the accelerator pedal, this could cause an accident or fire due to engine overheating. Additionally, if the vehicle is parked in a poorly ventilated area, exhaust gases may collect and enter the vehicle, leading to death or a serious health hazard.

 CAUTION

■ **When braking**

- When the brakes are wet, drive more cautiously.
Braking distance increases when the brakes are wet, and this may cause one side of the vehicle to brake differently than the other side. Also, the parking brake may not securely hold the vehicle.
- If the power brake assist function does not operate, do not follow other vehicles closely and avoid hills or sharp turns that require braking.
In this case, braking is still possible, but the brake pedal should be depressed more firmly than usual. Also, the braking distance will increase. Have your brakes fixed immediately.
- Do not pump the brake pedal if the engine stalls.
Each push on the brake pedal uses up the reserve for the power-assisted brakes.
- The brake system consists of 2 individual hydraulic systems; if one of the systems fails, the other will still operate. In this case, the brake pedal should be depressed more firmly than usual and the braking distance will increase.
Have your brakes fixed immediately.

 NOTICE

Pre-driving check

Trapping small animals in the cooling fan and belts of the engine may result in a malfunction. Check that no small animal enters the engine compartment and under the vehicle before starting the engine.

When driving the vehicle
Vehicles with an automatic transmission

- Do not depress the accelerator and brake pedals at the same time during driving, as this may restrain driving torque.
- Do not use the accelerator pedal or depress the accelerator and brake pedals at the same time to hold the vehicle on a hill.

Vehicles with a manual transmission

- Do not depress the accelerator and brake pedals at the same time during driving, as this may restrain driving torque.
- Do not shift gears unless the clutch pedal is fully depressed. After shifting, do not release the clutch pedal abruptly. Doing so may damage the clutch, transmission and gears.
- Observe the following to prevent the clutch from being damaged.
 - Do not rest your foot on the clutch pedal while driving.
Doing so may cause clutch trouble.
 - Do not use any gear other than the 1st gear when starting off and moving forward.
Doing so may damage the clutch.
 - Do not use the clutch to hold the vehicle when stopping on an uphill grade.
Doing so may damage the clutch.
- Do not shift the shift lever to R when the vehicle is still moving. Doing so may damage the clutch, transmission and gears.
- Do not release the clutch pedal too quickly. Doing so may damage the transmission.

When parking the vehicle (vehicles with an automatic transmission)

Always shift the shift lever to P. Failure to do so may cause the vehicle to move or the vehicle may accelerate suddenly if the accelerator pedal is accidentally depressed.



NOTICE

■ Avoiding damage to vehicle parts

- Do not turn the steering wheel fully in either direction and hold it there for an extended period of time.
Doing so may damage the power steering motor.
- When driving over bumps in the road, drive as slowly as possible to avoid damaging the wheels, underside of the vehicle, etc.
- On vehicles with an automatic transmission, do not race the engine for more than 5 seconds in any position except the N or P position when the brake is applied or when chocks are used in the wheels. This may cause the transmission fluid to overheat.

■ If you get a flat tire while driving

A flat or damaged tire may cause the following situations. Hold the steering wheel firmly and gradually depress the brake pedal to slow down the vehicle.

- It may be difficult to control your vehicle.
- The vehicle will make abnormal sounds or vibrations.
- The vehicle will lean abnormally.

Information on what to do in case of a flat tire (→P. 386, 395)

■ When encountering flooded roads

Do not drive on a road that has flooded after heavy rain etc. Doing so may cause the following serious damage to the vehicle:

- Engine stalling
- Short in electrical components
- Engine damage caused by water immersion

In the event that you drive on a flooded road and the vehicle is flooded, be sure to have any authorized Toyota dealer or repairer, or another duly qualified and equipped professional check the following:

- Brake function
- Changes in quantity and quality of oil and fluid used for the engine, transmission, differential, etc.
- Lubricant condition for the propeller shaft, bearings and suspension joints (where possible) and the function of all joints, bearings, etc.

2-1. Driving procedures

Engine (ignition) switch (vehicles with a smart entry & start system)

Performing the following operations when carrying the electronic key on your person starts the engine or changes “ENGINE START STOP” switch modes.

■ Starting the engine

Vehicles with an automatic transmission

STEP 1 Check that the parking brake is set.

STEP 2 Check that the shift lever is set in P.

If the shift lever is not set in P, the engine may not be started.
(→P. 181)

STEP 3 Firmly depress the brake pedal.

The smart entry & start system indicator light (green) will turn on.
If the indicator light does not turn on, the engine cannot be started.

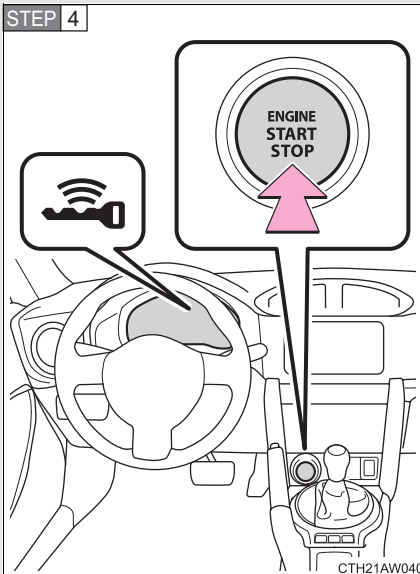

Press the “ENGINE START STOP” switch.

The engine will crank until it starts or for up to 10 seconds, whichever is less.

Continue depressing the brake pedal until the engine is completely started.

The engine can be started from any “ENGINE START STOP” switch mode.

Vehicles with a manual transmission

STEP 1 Check that the parking brake is set.

STEP 2 Check that the shift lever is set in N.

STEP 3 Firmly depress the clutch pedal.

The smart entry & start system indicator light (green) will turn on. If the indicator light does not turn on, the engine cannot be started.

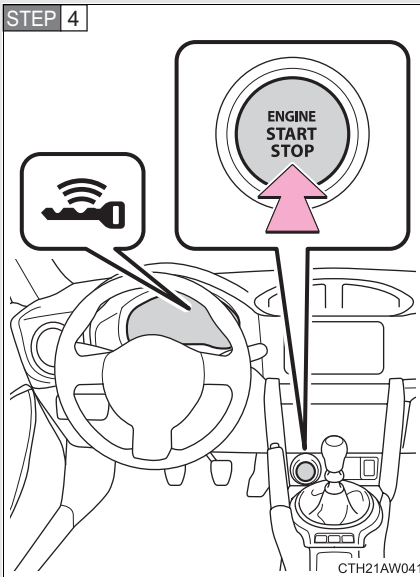

Press the “ENGINE START STOP” switch.

The engine will crank until it starts or for up to 10 seconds, whichever is less.

Continue depressing the clutch pedal until the engine is completely started.

The engine can be started from any “ENGINE START STOP” switch mode.

■ Stopping the engine

Vehicles with an automatic transmission

- STEP 1** Stop the vehicle.
- STEP 2** Shift the shift lever to P.
- STEP 3** Set the parking brake. (→P. 192)
- STEP 4** Release the brake pedal.
- STEP 5** Press the “ENGINE START STOP” switch.
- STEP 6** Check that the smart entry & start system indicator light (green) is off.

Vehicles with a manual transmission

- STEP 1** While depressing the clutch pedal, stop the vehicle.
- STEP 2** Shift the shift lever to N.
- STEP 3** Set the parking brake. (→P. 192)
- STEP 4** Release the clutch pedal.
- STEP 5** Press the “ENGINE START STOP” switch.
- STEP 6** Check that the smart entry & start system indicator light (green) is off.

■ Changing “ENGINE START STOP” switch mode

Modes can be changed by pressing the “ENGINE START STOP” switch with the brake pedal (vehicles with an automatic transmission) or clutch pedal (vehicles with a manual transmission) released. (The mode changes each time the switch is pressed.)

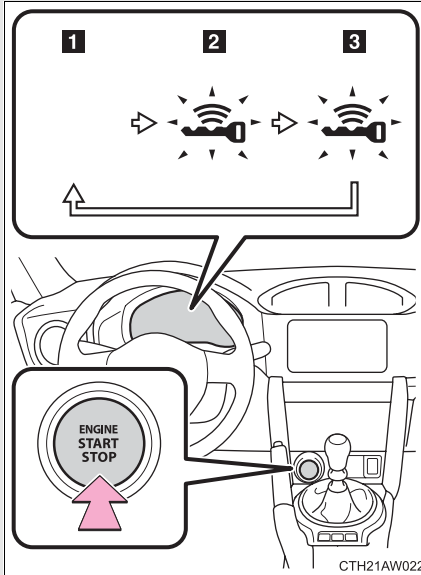

1 Off*

The emergency flashers can be used.

The smart entry & start system indicator light (green) is off.

2 ACCESSORY mode

Some electrical components such as the power outlet can be used.

The smart entry & start system indicator light (green) flashes slowly.

3 IGNITION ON mode

All electrical components can be used.

The smart entry & start system indicator light (green) flashes slowly.

*: Vehicles with an automatic transmission: If the shift lever is in a position other than P when turning off the engine, the “ENGINE START STOP” switch will be turned to ACCESSORY mode, not to off.

When stopping the engine with the shift lever in a position other than P (vehicles with an automatic transmission)

If the engine is stopped with the shift lever in a position other than P, the “ENGINE START STOP” switch will not be turned off but instead be turned to ACCESSORY mode. Perform the following procedure to turn the switch off:

STEP 1 Check that the parking brake is set.

STEP 2 Shift the shift lever to P.

STEP 3 Check that the smart entry & start system indicator light (green) flashes slowly and then press the “ENGINE START STOP” switch once.

STEP 4 Check that the smart entry & start system indicator light (green) is off.

Auto power off function**Vehicles with an automatic transmission**

If the vehicle is left in ACCESSORY mode for more than 20 minutes or IGNITION ON mode (the engine is not running) for more than an hour with the shift lever in P, the “ENGINE START STOP” switch will automatically turn off. However, this function cannot entirely prevent battery discharge. Do not leave the vehicle with the “ENGINE START STOP” switch in ACCESSORY or IGNITION ON mode for long periods of time when the engine is not running.

Vehicles with a manual transmission

If the vehicle is left in ACCESSORY mode for more than 20 minutes or IGNITION ON mode (the engine is not running) for more than an hour, the “ENGINE START STOP” switch will automatically turn off. However, this function cannot entirely prevent battery discharge. Do not leave the vehicle with the “ENGINE START STOP” switch in ACCESSORY or IGNITION ON mode for long periods of time when the engine is not running.

■ Operation of the “ENGINE START STOP” switch

When operating the “ENGINE START STOP” switch, one short, firm press is enough. If the switch is pressed improperly, the engine may not start or the “ENGINE START STOP” switch mode may not change. It is not necessary to press and hold the switch.

■ Electronic key battery depletion

→P. 44

■ Conditions affecting operation

→P. 40

■ Note for the entry function

→P. 41

■ If the engine does not start

The engine immobilizer system may not have been deactivated. (→P. 92)
Contact any authorized Toyota dealer or repairer, or another duly qualified and equipped professional.

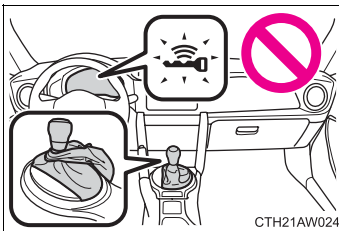

Vehicles with an automatic transmission:
Check that the shift lever is securely set in P. The engine may not start if the shift lever is displaced out of P. The smart entry & start system indicator light (green) will flash quickly.

■ Steering lock

After turning the “ENGINE START STOP” switch off and opening and closing the doors, the steering wheel will be locked due to the steering lock function. Operating the “ENGINE START STOP” switch again automatically cancels the steering lock.

■ When the steering lock cannot be released

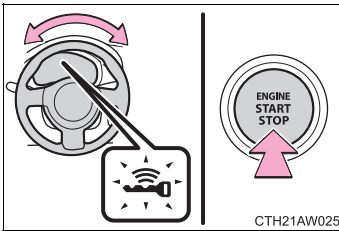

The smart entry & start system indicator light (green) will flash quickly.

Vehicles with an automatic transmission

Check that the shift lever is set in P. Press the “ENGINE START STOP” switch while turning the steering wheel left and right.

Vehicles with a manual transmission

Press the “ENGINE START STOP” switch while turning the steering wheel left and right.

■ Steering lock motor overheating prevention

To prevent the steering lock motor from overheating, the motor may be suspended if the engine is turned on and off repeatedly in a short period of time. In this case, refrain from operating the engine. After about 10 seconds, the steering lock motor will resume functioning.

■ When the smart entry & start system indicator light flashes in yellow

The system may be malfunctioning. Have the vehicle inspected by any authorized Toyota dealer or repairer, or another duly qualified and equipped professional immediately.

■ If the electronic key battery is depleted

→P. 332

■ If the smart entry & start system has been deactivated in a customized setting

→P. 417

■ Immediately after reconnecting the battery terminals due to replacing the battery and so forth

The engine may not start. If this occurs, turn the “ENGINE START STOP” switch to IGNITION ON mode, and start the engine after waiting at least 10 seconds. Idling may be unstable immediately after the engine starts, however, this is not a malfunction.



CAUTION

■ When starting the engine

- Always start the engine while sitting in the driver's seat. Do not depress the accelerator pedal while starting the engine under any circumstances. Doing so may cause an accident resulting in death or serious injury.
- If the smart entry & start system indicator light flashes in green after the engine has started, never drive the vehicle. The steering wheel is still locked, and it may result in an accident.

■ Caution while driving

If engine failure occurs while the vehicle is moving, do not lock or open the doors until the vehicle reaches a safe and complete stop. Activation of the steering lock in this circumstance may lead to an accident, resulting in death or serious injury.

■ Stopping the engine in an emergency

If you want to stop the engine in an emergency while driving the vehicle, press and hold the "ENGINE START STOP" switch for more than 2 seconds, or press it briefly 3 times or more in succession. (→P. 430)
However, do not touch the "ENGINE START STOP" switch while driving except in an emergency. Turning the engine off while driving will not cause loss of steering or braking control, but the power assist to these systems will be lost. This will make it more difficult to steer and brake, so you should pull over and stop the vehicle as soon as it is safe to do so.

**NOTICE****■ To prevent battery discharge**

- Do not leave the “ENGINE START STOP” switch in ACCESSORY or IGNITION ON mode for long periods of time without the engine running.
- If the smart entry & start system indicator light (green) is illuminated, the “ENGINE START STOP” switch is not off. When exiting the vehicle, always check that the “ENGINE START STOP” switch is off.
- Vehicles with an automatic transmission: Do not stop the engine when the shift lever is in a position other than P. If the engine is stopped in another shift lever position, the “ENGINE START STOP” switch will not be turned off but instead be turned to ACCESSORY mode. If the vehicle is left in ACCESSORY mode, battery discharge may occur.

■ When starting the engine

- Do not race a cold engine.
- If the engine becomes difficult to start or stalls frequently, have your vehicle checked by authorized Toyota dealer or repairer, or another duly qualified and equipped professional immediately.

■ Symptoms indicating a malfunction with the “ENGINE START STOP” switch

If the “ENGINE START STOP” switch seems to be operating somewhat differently than usual, such as the switch sticking slightly, there may be a malfunction. Contact any authorized Toyota dealer or repairer, or another duly qualified and equipped professional immediately.

2-1. Driving procedures

Engine (ignition) switch (vehicles without a smart entry & start system)

■ Starting the engine

Vehicles with an automatic transmission

- STEP 1** Check that the parking brake is set.
- STEP 2** Check that the shift lever is set in P.
- STEP 3** Firmly depress the brake pedal.
- STEP 4** Turn the engine switch to the “START” position to start the engine.

Vehicles with a manual transmission

- STEP 1** Check that the parking brake is set.
- STEP 2** Check that the shift lever is set in N.
- STEP 3** Firmly depress the clutch pedal.
- STEP 4** Turn the engine switch to the “START” position to start the engine.

■ Changing the engine switch positions

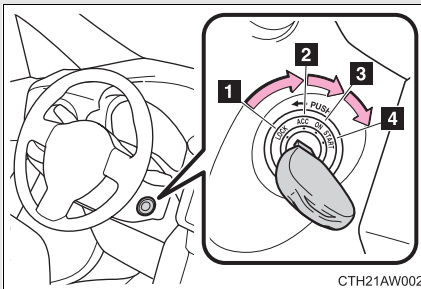

1 “LOCK”

The steering wheel is locked and the key can be removed. (Vehicles with an automatic transmission: The key can be removed only when the shift lever is in P.)

2 “ACC”

Some electrical components such as the power outlet can be used.

3 “ON”

All electrical components can be used.

4 “START”

For starting the engine.

■ Turning the key from “ACC” to “LOCK”

STEP 1 Shift the shift lever to N (manual transmission) or P (automatic transmission). (→P. 181, 188)

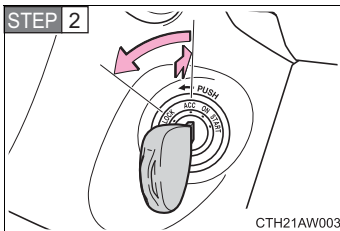

Push in the key and turn to the “LOCK” position.

■ If the engine does not start

The engine immobilizer system may not have been deactivated. (→P. 92)
Contact any authorized Toyota dealer or repairer, or another duly qualified and equipped professional.

■ When the steering lock cannot be released

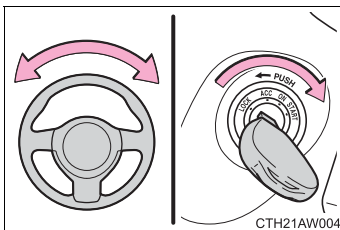

When starting the engine, the engine switch may seem stuck in the “LOCK” position. To free it, turn the key while turning the steering wheel slightly left and right.

■ Key reminder function

A buzzer sounds if the driver’s door is opened while the engine switch is in the “LOCK” or “ACC” position to remind you to remove the key.

■ Immediately after reconnecting the battery terminals due to replacing the battery and so forth

The engine may not start. If this occurs, turn the engine switch to the “ON” position, and start the engine after waiting at least 10 seconds. Idling may be unstable immediately after the engine starts, however, this is not a malfunction.

 CAUTION

■ **When starting the engine**

Always start the engine while sitting in the driver's seat. Do not depress the accelerator pedal while starting the engine under any circumstances. Doing so may cause an accident resulting in death or serious injury.

■ **Caution when driving**

Do not turn the engine switch to the "LOCK" position while driving. If, in an emergency, you must turn the engine off while the vehicle is moving, turn the engine switch only to the "ACC" position to stop the engine. An accident may result if the engine is stopped while driving. (→P. 430)

 NOTICE

■ **To prevent battery discharge**

Do not leave the engine switch in the "ACC" or "ON" position for long periods of time without the engine running.

■ **When starting the engine**

- Do not crank the engine for more than 10 seconds at a time. This may overheat the starter and wiring system.
If the engine does not start, turn the engine switch to the "LOCK" position and try to start the engine again after waiting for 10 seconds or more.
- Do not race a cold engine.
- If the engine becomes difficult to start or stalls frequently, have your vehicle checked by any authorized Toyota dealer or repairer, or another duly qualified and equipped professional immediately.

Select a shift position appropriate for the driving conditions.

■ Shifting the shift lever

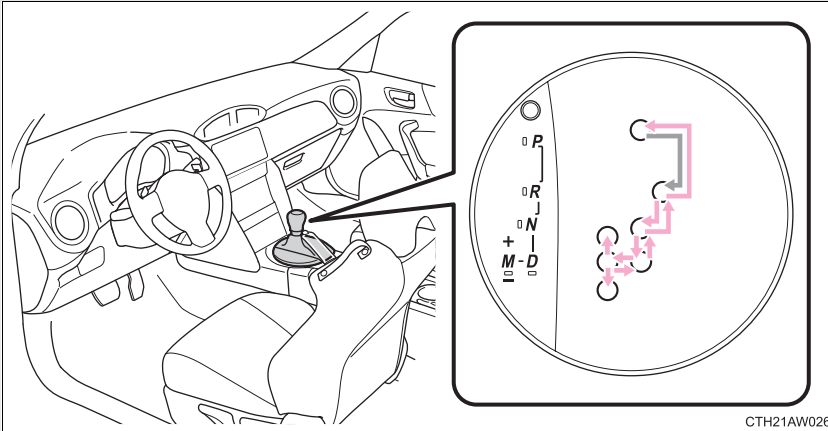

Vehicles without a smart entry & start system

While the engine switch is in the “ON” position, move the shift lever with the brake pedal depressed.

When shifting the shift lever between P and D, make sure that the vehicle is completely stopped.







Vehicles with a smart entry & start system

While the “ENGINE START STOP” switch is in IGNITION ON mode, move the shift lever with the brake pedal depressed.

When shifting the shift lever between P and D, make sure that the vehicle is completely stopped.

*: If equipped

■ Shift position uses

Shift position	Meter display	Function
P		Parking the vehicle/starting the engine
R		Reversing
N		Neutral
D		Normal D position driving* (gears between "1" and "6" are automatically selected)
	 (paddle shift switches activated)	Temporary manual mode driving (→P. 186)
M		Manual mode driving (→P. 184)

*: Shifting to the D position allows the system to select a gear suitable for the driving conditions. Setting the shift lever to the D position is recommended for normal driving.

■ Selecting a driving mode

By pressing the driving pattern selector switch the following modes can be selected to suit driving and usage conditions:

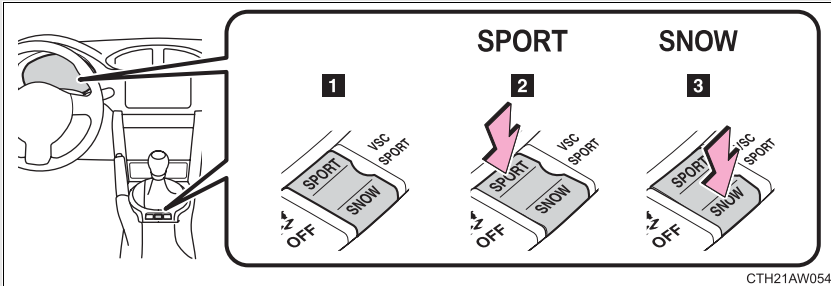

1 Normal mode

2 Sport mode

The “SPORT” indicator comes on.

Use sport mode for sporty driving or when driving in mountainous regions with lots of curves.

3 Snow mode

The “SNOW” indicator comes on.

Use snow mode for accelerating and driving on slippery road surfaces such as snow.

To cancel sport mode or snow mode, press the same side of the switch again.

Manual mode driving

To enter manual mode, shift the shift lever to the M position.

When the Gear Shift Indicator is on, gears can be selected by operating the shift lever or paddle shift switches (if equipped), allowing you to drive in the gear of your choosing.

The Gear Shift Indicator display is a guide to help the driver achieve improved fuel economy and reduced exhaust emissions within limits of engine performance.

Even if upshifting operations are performed, if vehicle speed is too low for the requested gear, the gear will not change.

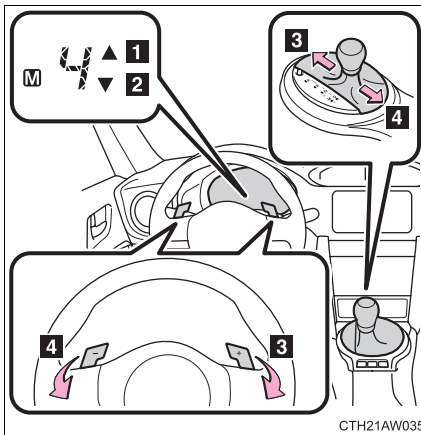

- 1** Upshift indicator
- 2** Downshift indicator
- 3** Upshifting (+)
- 4** Downshifting (-)

Each time the shift lever or paddle shift switches are operated, the gear changes up or down one gear and the selected gear, "1" through "6", will be set.

The selected gear, from "1" to "6", and "M" will be displayed on the shift position and shift range indicator.

When in manual mode, the gear will not change unless the shift lever or paddle shift switches are operated.

However, even when in manual mode, the gears will be automatically changed in the following situations:

- When vehicle speed drops (downshift only).
- When engine oil temperature is high and engine speed rises close to the red zone.

■ When moving the shift lever out of P

If the shift lever is pushed sideways before the brake pedal is depressed, shift lever operation may not be possible. Depress the brake pedal before shifting the shift lever out of P.

■ Downshifting restrictions warning buzzer

If downshifting operations are performed at a vehicle speed by which downshifting is not possible (when downshifting will cause the engine speed to enter the red zone), a buzzer will sound to warn the driver that downshifting cannot be performed.

■ When driving with cruise control activated (if equipped)

Downshifting can be performed even when using cruise control. After downshifting, the set speed continues. (→P. 184, 186)

■ Sport mode

- In sport mode, lower gears are used and gears change at a higher engine speed.
- If sport mode is changed to while the shift lever is in the M position, the “SPORT” indicator will come on but sport mode controls will not be carried out. Shift the shift lever to the D position.
- Sport mode cannot be changed to when driving with cruise control activated.

■ Snow mode

To prevent slipping, 1st gear cannot be selected when in snow mode.

■ Sport mode and snow mode automatic deactivation

In the following situations, the driving mode is automatically deactivated:

- When the engine is turned off after driving in sport mode or snow mode.
- When cruise control is activated while driving in sport mode.

■ If the shift lever cannot be shifted from P

→P. 414

■ Automatic gear selection when the vehicle is stopped

When the vehicle is idling at high rpm in order to warm up, and the vehicle is on a slippery road, the transmission may automatically shift to 2nd gear for stopping and starting off.

■ Temporary manual mode driving (vehicles with paddle shift switches)

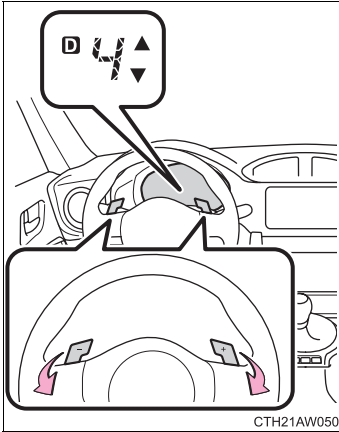

Temporary manual mode driving can be changed to by operating the paddle shift switches while the shift lever is in the D position.

When this occurs, the selected gear and “D” are displayed on the shift position and shift range indicator.

(When engine speed rises close to the red zone, upshifting will be automatically performed.)

Gear Shift Indicator: →P. 184

Temporary manual mode driving will be deactivated and normal D position driving will be returned to in the following situations:

- When driving for longer than the set time (the set time differs according to driving conditions).
- When the vehicle comes to a stop.
- When the accelerator pedal is continually depressed for longer than the set time.
- When the accelerator pedal is fully, or near-fully, depressed.

■ AI-SHIFT

The AI-SHIFT automatically shifts the gear to the suitable position according to the driver performance and driving conditions.

The AI-SHIFT automatically operates when the shift lever is in the D position. (Operating the paddle shift switches or shifting the shift lever to the M position cancels the function.)

CAUTION

■ When driving on slippery road surfaces

Be careful of downshifting and sudden acceleration, as this could result in the vehicle skidding to the side or spinning.

■ To prevent incorrect operation

Do not attach items such as accessories to the paddle shift switches. Doing so may unintentionally move the paddle shift switches.

■ Gear Shift Indicator

The indication of the gear shift indicator is only as a guideline for driving more fuel-efficiently. The indicator does not inform the driver about the safe shift operation timing. The driver has the responsibility for suitable shift operation depending on the traffic conditions or driving conditions (e.g., overtaking or driving on an uphill slope).

This indicator supports the driver to drive more fuel-efficiently. The vehicle system determines the shift operation timing depending on the driving conditions, and informs the driver by the indicator on the combination meter. For details, refer to Gear shift indicator.

2-1. Driving procedures

Manual Transmission*

■ Shifting the shift lever

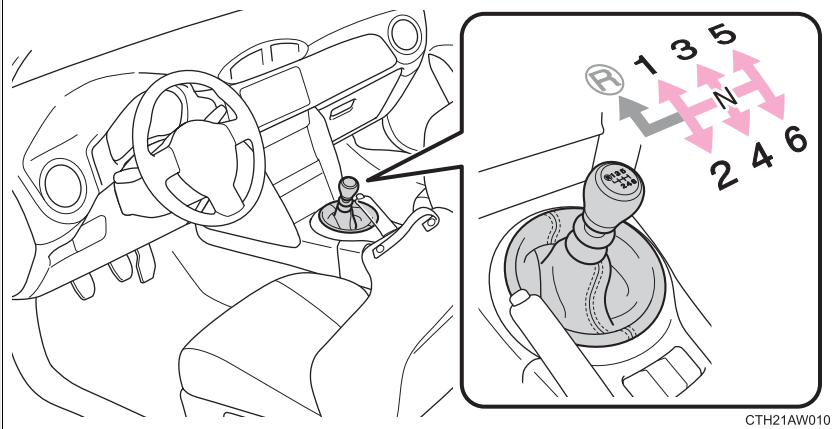

Fully depress the clutch pedal before operating the shift lever, and then release it slowly.

■ Shifting the shift lever to R

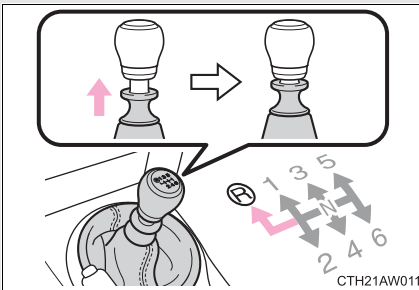

Shift the shift lever to R while lifting up the ring section.

*: If equipped

Shift position indicator

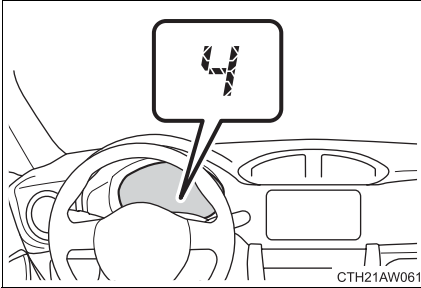

The selected shift position will be displayed on the multi-information display.

The selected shift position will not appear in the following situations:

- When the shift lever is in N.
- When the vehicle speed is 10 km/h (6 mph) or less (except when the shift lever is in R).
- When the clutch pedal is depressed.

Gear Shift Indicator

The Gear Shift Indicator display is a guide to help the driver achieve improved fuel economy and reduced exhaust emissions within limits of engine performance.

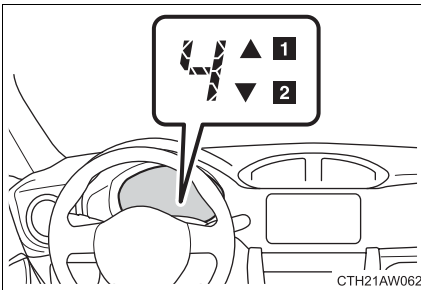

1 Upshift indicator

2 Downshift indicator

The Gear Shift Indicator cannot be deactivated.

■ Gear Shift Indicator display

- The Gear Shift Indicator may not be displayed when your foot is placed on the clutch pedal.
- The Gear Shift Indicator may operate to prevent a possible engine stall at a low engine speed.

⚠ CAUTION

■ Gear Shift Indicator

The indication of the gear shift indicator is only as a guideline for driving more fuel-efficiently. The indicator does not inform the driver about the safe shift operation timing. The driver has the responsibility for suitable shift operation depending on the traffic conditions or driving conditions (e.g., overtaking or driving on an uphill slope).

This indicator supports the driver to drive more fuel-efficiently. The vehicle system determines the shift operation timing depending on the driving conditions, and informs the driver by the indicator on the combination meter. For details, refer to Gear shift indicator.

Usually, the gear shift indicator is a guideline for driving more fuel-efficiently, and it also may operate to prevent a possible stall at a low engine speed.

⚠ NOTICE

■ To prevent damage to the transmission

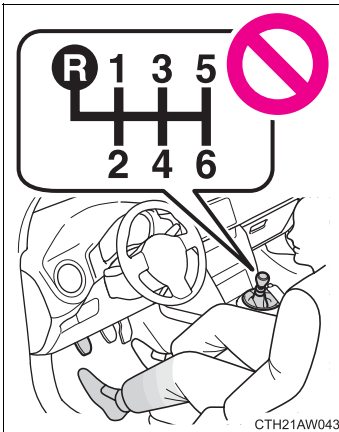

- Do not shift the shift lever without depressing the clutch pedal.

- Do not lift up the ring section except when shifting the lever to R.
- Shift the shift lever to R only when the vehicle is stationary and the clutch pedal is fully depressed.

2-1. Driving procedures

Turn signal lever

The turn signal lever can be used to show the following intentions of the driver:

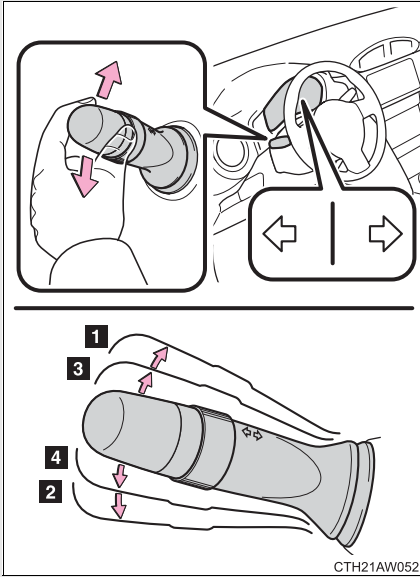

- 1 Right turn
- 2 Left turn
- 3 Lane change to the right (push and hold the lever partway)

The right hand signals will flash until you release the lever.

- 4 Lane change to the left (push and hold the lever partway)

The left hand signals will flash until you release the lever.

■ Turn signals can be operated when

Vehicles without a smart entry & start system

The engine switch is in the "ON" position.

Vehicles with a smart entry & start system

The "ENGINE START STOP" switch is in IGNITION ON mode.

■ If the indicators flash faster than usual

Check that a light bulb in the turn signal lights has not burned out.

2-1. Driving procedures

Parking brake

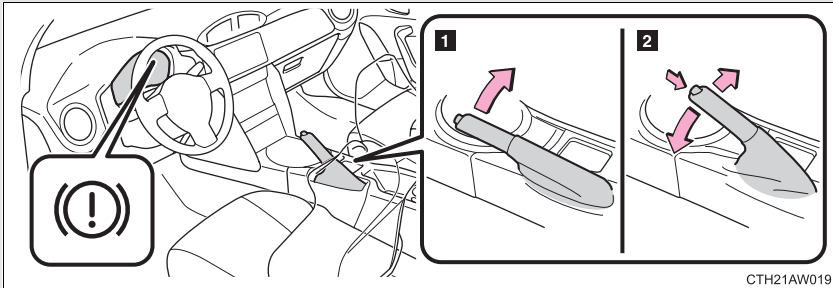

- 1** To set the parking brake, fully pull the parking brake lever while depressing the brake pedal.
- 2** To release the parking brake, slightly raise the lever and lower it completely while pressing the button.

■ Usage in winter time

→P. 233

⚠ NOTICE

■ Before driving

Fully release the parking brake.

Driving the vehicle with the parking brake set will lead to brake components overheating, which may affect braking performance and increase brake wear.

2-1. Driving procedures

Horn

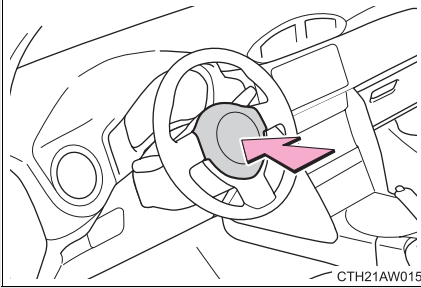

To sound the horn, press on or close to the  mark.

■ After adjusting the steering wheel

Make sure that the steering wheel is securely locked.

The horn may not sound if the steering wheel is not securely locked.

(→P. 79)

2-2. Instrument cluster

Gauges and meters

The illustration below is for left-hand drive vehicles.
The switch positions may differ slightly for right-hand drive vehicles.

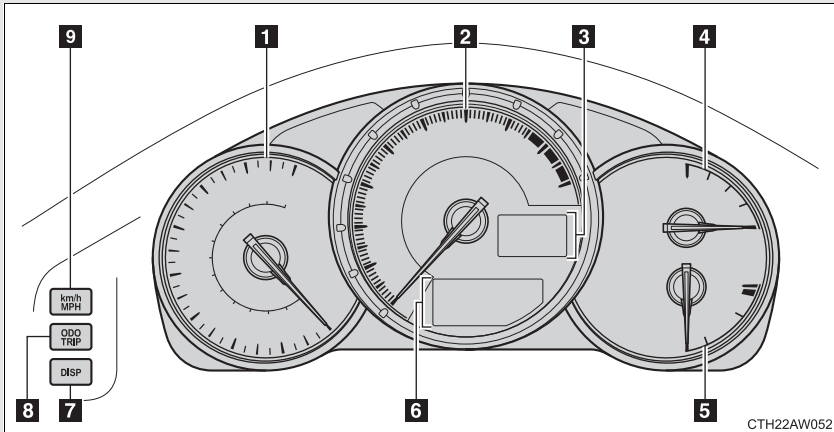

- 1** Analog Speedometer
Displays the vehicle speed.
- 2** Tachometer
Displays the engine speed in revolutions per minute.
- 3** Digital Speedometer (if equipped)
Displays the vehicle speed.
- 4** Fuel gauge
Displays the quantity of fuel remaining in the tank.
- 5** Engine coolant temperature gauge
Displays the engine coolant temperature.

6 Odometer, trip meter and multi-information display

Odometer: Displays the total distance the vehicle has been driven.

Trip meter: Displays the distance the vehicle has been driven since the meter was last reset. Trip meters A and B can be used to record and display different distances independently.

Multi-information display: Presents the driver with a variety of driving-related data. (→P. 203)

7 “DISP” switch

→P. 204

8 “ODO/TRIP” switch

→P. 196

9 “km/h MPH” switch (if equipped)

Each time the switch is pressed, the display inside the meter changes between km/h and MPH.

Switch the display

Each time the “ODO/TRIP” switch is pressed, the display changes as follows.

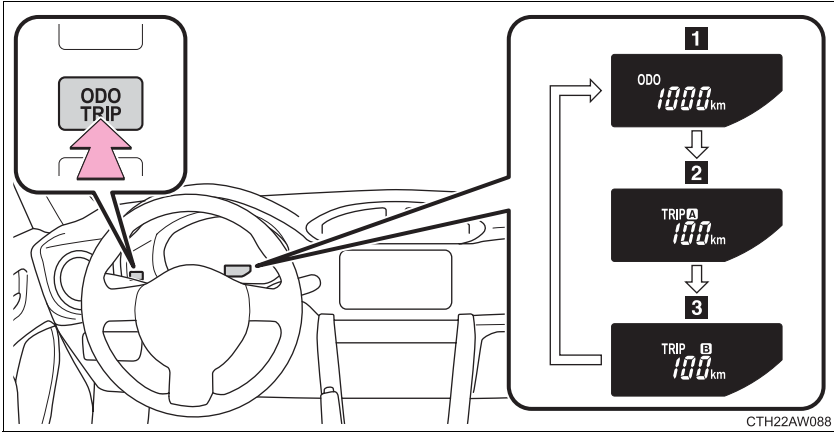

1 Odometer

2 Trip meter A*

3 Trip meter B*

*: Pressing and holding the “ODO/TRIP” switch will reset the trip meter that is currently displayed.

Instrument panel light control

The brightness of the instrument panel lights can be adjusted.

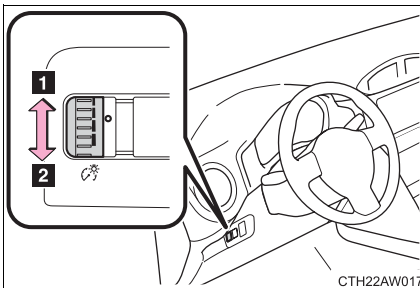

1 Brighter

2 Darker

■ The brightness of the instrument panel lights

When the front position lights or the headlights turn on, the instrument panel lights will dim. However, when the instrument panel brightness control dial is turned to the up most position, the instrument panel lights will not dim even when the front position lights or headlights turn on.



NOTICE

■ To prevent damage to the engine and its components

- Do not let the indicator needle of the tachometer enter the red zone, which indicates the maximum engine speed.
- The engine may be overheating if the temperature gauge is in the red zone (H). In this case, immediately stop the vehicle in a safe place, and check the engine after it has cooled completely. (→P. 425)

2-2. Instrument cluster

Indicators and warning lights

The indicator and warning lights on the instrument cluster and center panel inform the driver of the status of the vehicle's various systems.

For the purpose of explanation, the following illustration displays all indicators and warning lights illuminated.

Instrument cluster

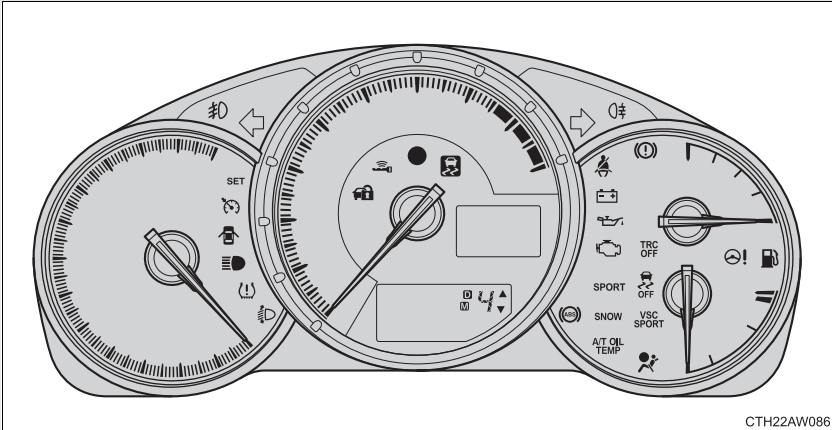

Center panel

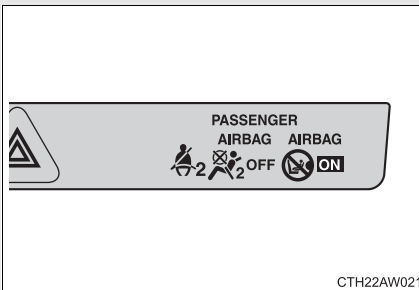

■ Indicators

The indicators inform the driver of the operating state of the vehicle's various systems.



Turn signal indicator
(→P. 191)



Headlight high beam indicator (→P. 209)



(If equipped)

Front fog light indicator
(→P. 215)



Rear fog light indicator
(→P. 215)



Security indicator
(→P. 92)



(If equipped)

Smart entry & start system indicator (→P. 169)



(Vehicles with an automatic transmission)

Shift position and shift range indicator
(→P. 182)



(Vehicles with an automatic transmission)

Gear Shift Indicator
(→P. 184, 186)



(Vehicles with an automatic transmission)

"SPORT" indicator
(→P. 183)



(Vehicles with an automatic transmission)

"SNOW" indicator
(→P. 183)



(Vehicles with a manual transmission)

Shift position indicator
(→P. 189)



(Vehicles with a manual transmission)

Gear Shift Indicator
(→P. 189)



*1, 2

Slip indicator
(→P. 225)



*1

"TRC OFF" indicator
(→P. 226)



*1

VSC off indicator
(→P. 228)



*1

"VSC SPORT" indicator
(→P. 226)



(If equipped)

REV indicator
(→P. 160)



(If equipped)

Cruise control indicator
(→P. 220)



(If equipped)

"SET" indicator
(→P. 220)



Airbag manual on-off indicator
(→P. 152)

***1: Vehicles without a smart entry & start system**

These lights turn on when the engine switch is turned to the “ON” position to indicate that a system check is being performed. They will turn off after the engine is started, or after a few seconds. There may be a malfunction in a system if a light does not come on, or if the lights do not turn off. Have the vehicle inspected by any authorized Toyota dealer or repairer, or another duly qualified and equipped professional for details.

Vehicles with a smart entry & start system

These lights turn on when the “ENGINE START STOP” switch is turned to IGNITION ON mode to indicate that a system check is being performed. They will turn off after the engine is started, or after a few seconds. There may be a malfunction in a system if a light does not come on, or if the lights do not turn off. Have the vehicle inspected by any authorized Toyota dealer or repairer, or another duly qualified and equipped professional for details.

***2:** The light flashes to indicate that the system is operating.

■ Warning lights

Warning lights inform the driver of malfunctions in any of the vehicle's systems. (→P. 374)

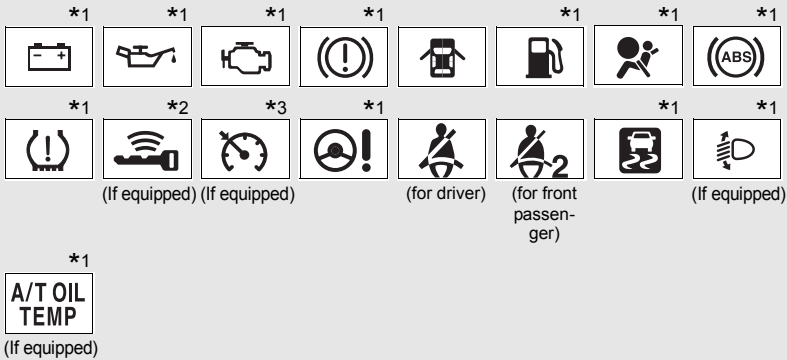

*1: Vehicles without a smart entry & start system

These lights turn on when the engine switch is turned to the “ON” position to indicate that a system check is being performed. They will turn off after the engine is started, or after a few seconds. There may be a malfunction in a system if a light does not come on, or if the lights do not turn off. Have the vehicle inspected by any authorized Toyota dealer or repairer, or another duly qualified and equipped professional for details.

Vehicles with a smart entry & start system

These lights turn on when the “ENGINE START STOP” switch is turned to IGNITION ON mode to indicate that a system check is being performed. They will turn off after the engine is started, or after a few seconds. There may be a malfunction in a system if a light does not come on, or if the lights do not turn off. Have the vehicle inspected by any authorized Toyota dealer or repairer, or another duly qualified and equipped professional for details.

*2: The light flashes in yellow to indicate a malfunction. The light flashes quickly in green to indicate that the steering lock has not been released.

*3: The light comes on in yellow to indicate a malfunction.

 CAUTION

■ **If a safety system warning light does not come on**

Should a safety system light such as the ABS and SRS warning light not come on when you start the engine, this could mean that these systems are not available to help protect you in an accident, which could result in death or serious injury. Have the vehicle inspected by any authorized Toyota dealer or repairer, or another duly qualified and equipped professional immediately if this occurs.

2-2. Instrument cluster

Multi-information display

The multi-information display presents the driver with a variety of driving-related data, including the current outside air temperature.

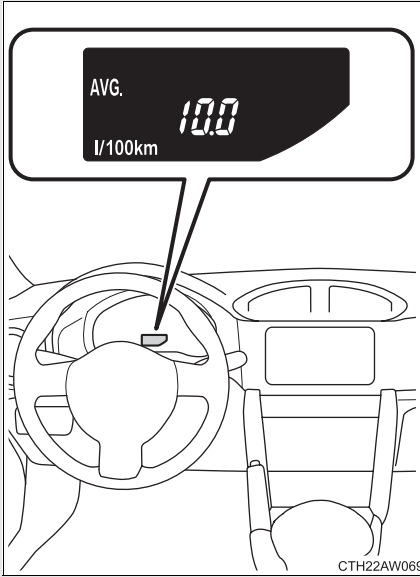

- Outside temperature
- Current fuel consumption
- Average fuel consumption
- Setting screen for the REV indicator (if equipped)

Switch the display

Each time the “DISP” switch is pressed, the display changes as follows.

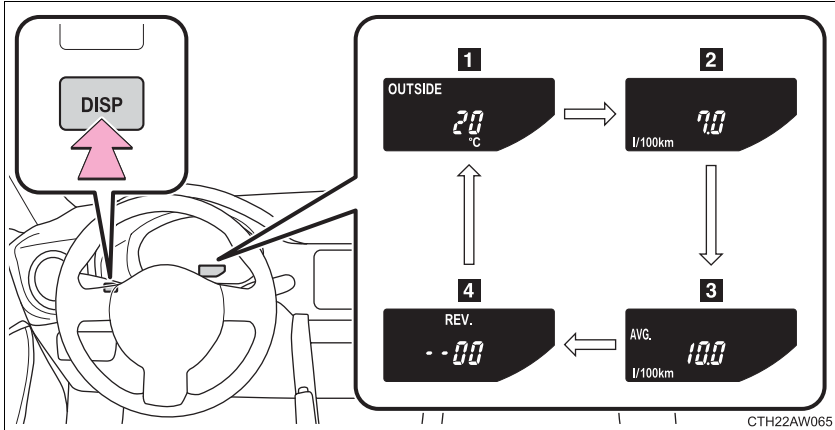

1 Outside temperature

→P. 269

2 Current fuel consumption

Displays the current rate of fuel consumption.

3 Average fuel consumption

Displays the average fuel consumption since the function was reset.

- The function can be reset by pushing the “DISP” switch for longer than one second when the average fuel consumption is displayed.
- Use the displayed average fuel consumption as a reference.

4 Setting screen for the REV indicator* (if equipped)

→P. 205

*: Only displayed when the vehicle is stopped.

Setting the REV indicator (if equipped)

■ Changing the REV indicator settings

The engine speed at which the REV indicator turns on at and whether a buzzer sounds or not when the light turns on can be set.

Engine speed setting range: From 2000 to 7400 rpm (r/min)

STEP 1 Press the “DISP” switch repeatedly until the setting screen is displayed. (→P. 204)

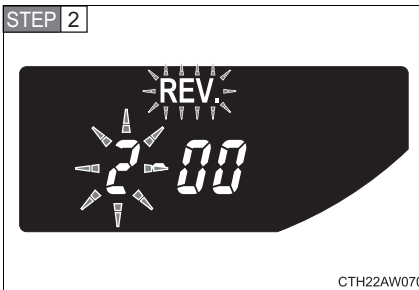

Press and hold the “DISP” switch.

“REV.” and the thousandth place flash. After flashing, the number changes each time the button is pressed and held.

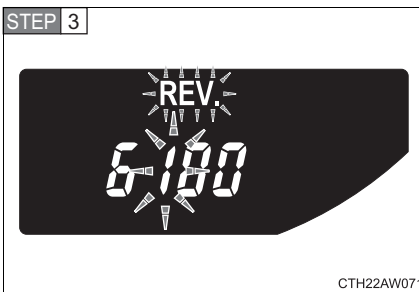

Press the “DISP” switch.

The hundredth place flashes. After flashing, the number changes each time the button is pressed and held.

STEP 4 Press the “DISP” switch.

A buzzer sounds once, and setting of the engine speed value is complete.

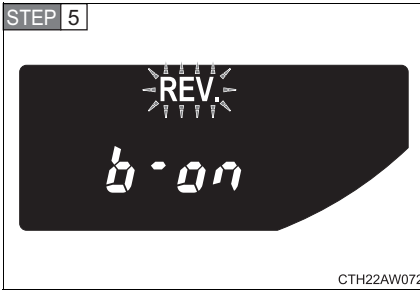

Press and hold the "DISP" switch.

Each time the "DISP" switch is pressed and held, the buzzer changes between activated and deactivated.

"b-on": Buzzer activated

"b-oFF": Buzzer deactivated

When the setting changes from "b-oFF" to "b-on", the buzzer sounds 3 times.

STEP 6 Press the "DISP" switch.

When the buzzer sounds, all settings have been completed. The settings are displayed.

■ Deactivating the REV indicator settings

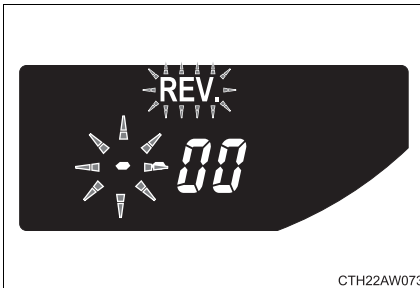

After setting the thousandth place to "-", press the "DISP" switch once.

■ **The multi-information display operate when**

Vehicles without a smart entry & start system

The engine switch is in the “ON” position.

Vehicles with a smart entry & start system

The “ENGINE START STOP” switch is in IGNITION ON mode.

 **CAUTION**

■ **The information display at low temperatures**

Allow the interior of the vehicle to warm up before using the liquid crystal information display. At extremely low temperatures, the information display monitor may respond slowly, and display changes may be delayed.

For example, there is a lag between the driver's shifting and the new shift position number appearing on the display. In this case, wait until the display changes and take care not to downshift again, causing rapid and excessive engine braking and possibly an accident resulting in death or serious injury.

2-3. Operating the lights and windshield wipers

Headlight switch

The headlights can be operated manually or automatically.

Turning the end of the lever turns on the lights as follows:

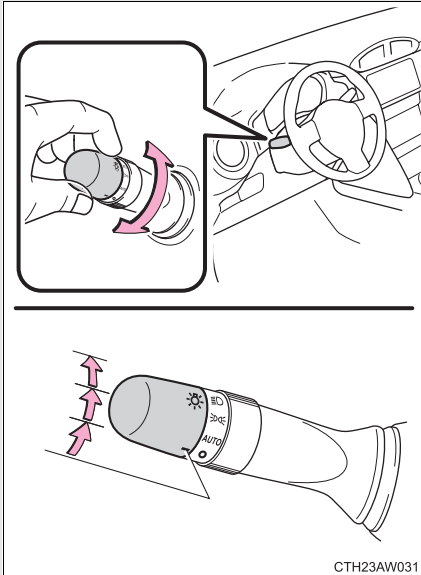

○ Off

The daytime running lights turn on. (→P. 211)

AUTO (if equipped)

The headlights, front position, daytime running lights (→P. 211) and so on turn on and off automatically. (Vehicles without a smart entry & start system: When the engine switch is in the “ON” position

Vehicles with a smart entry & start system: When the “ENGINE START STOP” switch is in IGNITION ON mode)

☞☞ The front position, tail, license plate and instrument panel lights turn on.

☞ The headlights and all the lights listed above (except daytime running lights) turn on.

Turning on the high beam headlights

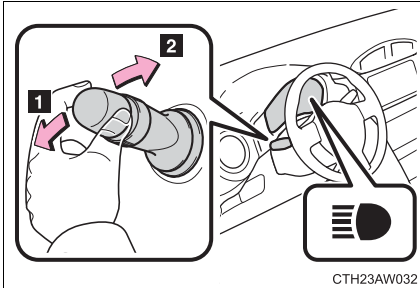

- 1 With the headlights on, push the lever forward to turn on the high beams.

Pull the lever back to the center position to turn the high beams off.

- 2 Pull the lever toward you and release it to flash the high beams once.

You can flash the high beams with the headlights on or off.

Manual headlight leveling dial (if equipped)

The level of the headlights can be adjusted according to the number of passengers and the loading condition of the vehicle.

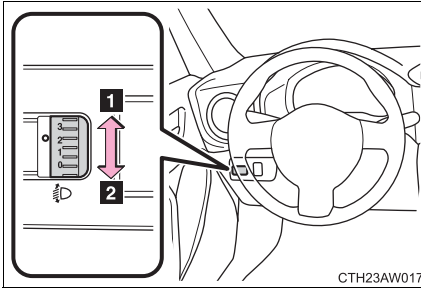

- 1** Raises the level of the headlights
- 2** Lowers the level of the headlights

■ Guide to dial settings

Occupancy and luggage load conditions		Dial position
Occupants	Luggage load	
Driver	None	0
Driver and front passenger	None	0
All seats occupied	None	1
All seats occupied	Full luggage loading	2
Driver	Full luggage loading	2

■ Daytime running light system

Vehicles with halogen headlights

Vehicles with an automatic transmission: To make your vehicle more visible to other drivers during daytime driving, the daytime running lights turn on automatically whenever the engine is started, the shift lever is shifted out of P and the parking brake is released with the headlight switch off or in the "AUTO" position. Daytime running lights are not designed for use at night.

Vehicles with a manual transmission: To make your vehicle more visible to other drivers during daytime driving, the daytime running lights turn on automatically whenever the engine is started and the parking brake is released with the headlight switch off or in the "AUTO" position. Daytime running lights are not designed for use at night.

Vehicles with discharge headlights

Vehicles with an automatic transmission: To make your vehicle more visible to other drivers during daytime driving, the daytime running lights turn on automatically whenever the engine is started, the shift lever is shifted out of P and the parking brake is released with the headlight switch off or in the "AUTO" position. (The front position lights illuminate.) Daytime running lights are not designed for use at night.

Vehicles with a manual transmission: To make your vehicle more visible to other drivers during daytime driving, the daytime running lights turn on automatically whenever the engine is started and the parking brake is released with the headlight switch off or in the "AUTO" position. (The front position lights illuminate.) Daytime running lights are not designed for use at night.

■ Headlight control sensor (if equipped)

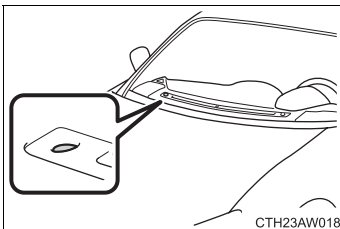

Headlight control sensor is located on the passenger's side.



The sensor may not function properly if an object is placed on the sensor, or anything that blocks the sensor is affixed to the windshield.

Doing so interferes with the sensor detecting the level of ambient light and may cause the automatic headlight system to malfunction.

■ **Automatic light off system (if equipped)**



Vehicles without a smart entry & start system

When the light switch is in  or **AUTO**: The headlights turn off automatically if the key is removed from the engine switch.

To turn the lights on again, turn the engine switch to the “ON” position, or turn the light switch off once and then back to  or .

Vehicles with a smart entry & start system

When the light switch is in  or **AUTO**: The headlights turn off automatically if the “ENGINE START STOP” switch is turned off.

To turn the lights on again, turn the “ENGINE START STOP” switch to IGNITION ON mode, or turn the light switch off once and then back to  or .

■ **Light reminder buzzer**

Vehicles without a smart entry & start system

A buzzer sounds when the engine switch is turned to “LOCK” position and the driver's door is opened with the key removed from the engine switch while the lights are turned on.

Vehicles with a smart entry & start system

A buzzer sounds when the “ENGINE START STOP” switch is turned off or turned to ACCESSORY mode and the driver's door is opened while the lights are turned on.

■ **Automatic headlight leveling system (if equipped)**

The level of the headlights is automatically adjusted according to the number of passengers and the loading condition of the vehicle to ensure that the headlights do not interfere with other road users.

■ Battery-saving function (if equipped)

In the following conditions, the headlights and the other remaining lights will go off automatically after 20 minutes in order to prevent the vehicle battery from being discharged:

- The headlights and/or tail lights are on.
- The key is removed from the engine switch (vehicles without a smart entry & start system) or the “ENGINE START STOP” switch is turned off (vehicles with a smart entry & start system).
- The light switch is in  or **AUTO**.

This function will be canceled in any of the following situations:

- When the engine switch is turned to the “ON” position (vehicles without a smart entry & start system) or the “ENGINE START STOP” switch is turned to IGNITION ON mode (vehicles with a smart entry & start system)
- When the light switch is operated
- When the door is opened or closed

■ **Turning on the low beam headlights when the vehicle is parked in dark areas**

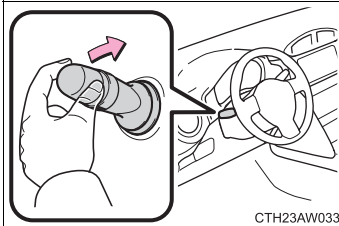

Turn off the engine with the light switch in **AUTO** or off, and pull the light switch toward you and release it. The low beam headlights will turn on for about 30 seconds to light up the area around the vehicle.

The lights are turned off in the following situations.

- Vehicles without a smart entry & start system: The engine switch is turned to the “ON” position.
- Vehicles with a smart entry & start system: The “ENGINE START STOP” switch is turned to IGNITION ON mode.
- The light switch is turned on.
- The light switch is pulled toward you and then released.

■ **Customization that can be configured at any authorized Toyota dealer or repairer, or another duly qualified and equipped professional**

Settings (e.g. light sensor sensitivity) can be changed.
(Customizable features →P. 449)

 **NOTICE**

■ **To prevent battery discharge**

Do not leave the lights on longer than necessary when the engine is not running.

2-3. Operating the lights and windshield wipers

Fog light switch*

The fog lights secure excellent visibility in difficult driving conditions, such as in rain and fog.

Rear fog light switch

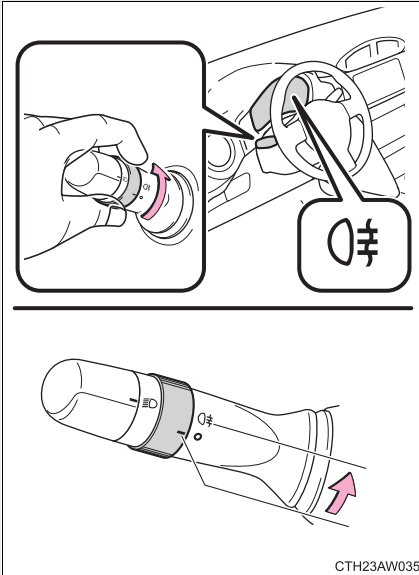

Turns the rear fog lights on.

Releasing the switch ring returns it to .

Operating the switch ring again turns the rear fog lights off.

*: If equipped

Front and rear fog light switch

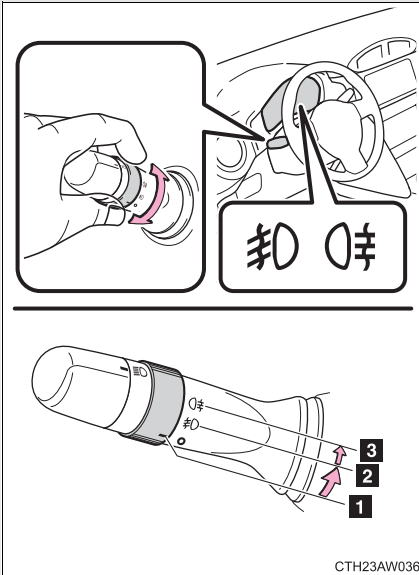

- 1 Turns the front and rear fog lights off
- 2 Turns the front fog lights on
- 3 Turns both front and rear fog lights on

Releasing the switch ring returns it to .

Operating the switch ring again turns only the rear fog lights off.

■ Fog lights can be used when

Rear fog light switch

The headlights or front position lights are turned on.

Front and rear fog light switch

Front fog lights: The headlights or front position lights are turned on.

Rear fog lights: The front fog lights are turned on.

2-3. Operating the lights and windshield wipers

Windshield wipers and washer

When intermittent windshield wiper operation is selected, the wiper interval can be adjusted.

The wiper operation is selected by moving the lever as follows.

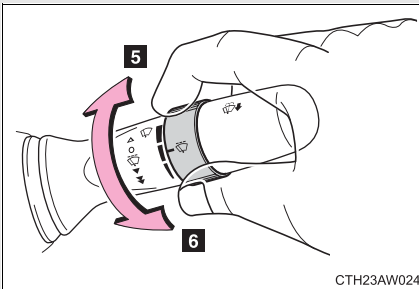
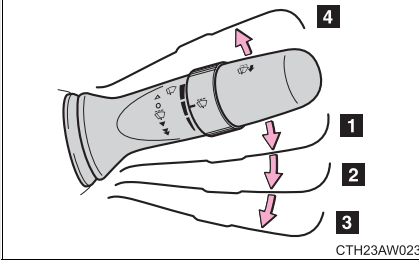
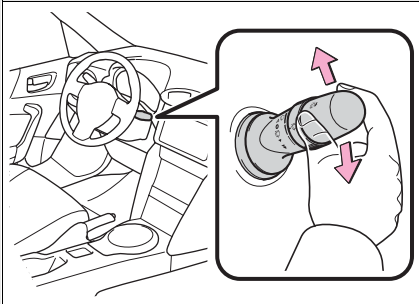

- 1 Intermittent windshield wiper operation
- 2 Low speed windshield wiper operation
- 3 High speed windshield wiper operation
- 4 Temporary operation

- 5 Decreases the intermittent windshield wiper frequency
- 6 Increases the intermittent windshield wiper frequency

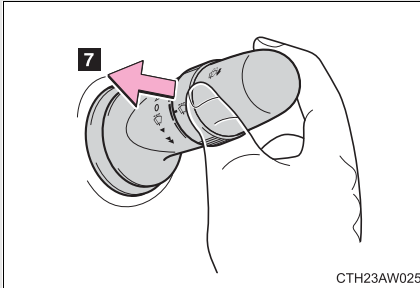

7 Washer/wiper dual operation

The wipers will automatically operate a couple of times after the washer squirts.

Vehicles with discharge headlights: When the headlights are on and the lever is pulled and held, the headlight cleaners will operate once.

■ The windshield wipers and washer can be operated when

Vehicles without a smart entry & start system

The engine switch is in the “ON” position.

Vehicles with a smart entry & start system

The “ENGINE START STOP” switch is in IGNITION ON mode.

■ If no windshield washer fluid sprays

Check that the washer nozzles are not blocked if there is washer fluid in the windshield washer fluid tank.

⚠ CAUTION

■ Caution regarding the use of washer fluid

When it is cold, do not use the washer fluid until the windshield becomes warm. The fluid may freeze on the windshield and cause low visibility. This may lead to an accident, resulting in death or serious injury.

**NOTICE****■ When the windshield is dry**

Do not use the wipers, as they may damage the windshield.

■ When the washer fluid tank is empty

Do not operate the switch continually as the washer fluid pump may over-heat.

■ When a nozzle becomes blocked

In this case, contact any authorized Toyota dealer or repairer, or another duly qualified and equipped professional.

Do not try to clear it with a pin or other object. The nozzle will be damaged.

2-4. Using other driving systems

Cruise control*

Use the cruise control to maintain a set speed without depressing the accelerator pedal.

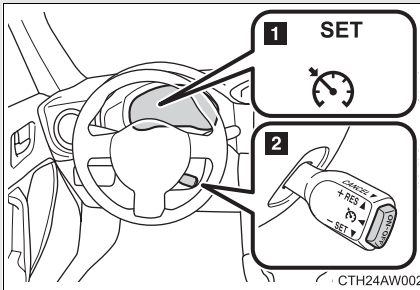

- 1 Indicators
- 2 Cruise control switch

■ Setting the vehicle speed

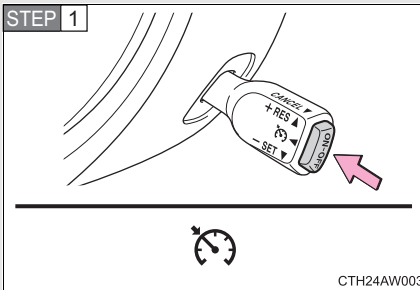

Press the “ON-OFF” button to activate the cruise control.

Cruise control indicator (green) will come on.

Press the button again to deactivate the cruise control.

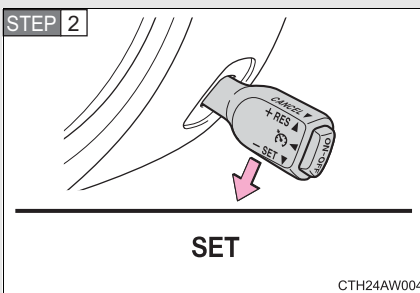

Accelerate or decelerate the vehicle to the desired speed, and push the lever down to set the speed.

“SET” indicator will come on.

The vehicle speed at the moment the lever is released becomes the set speed.

*: If equipped

■ Adjusting the set speed

To change the set speed, operate the lever until the desired set speed is obtained.

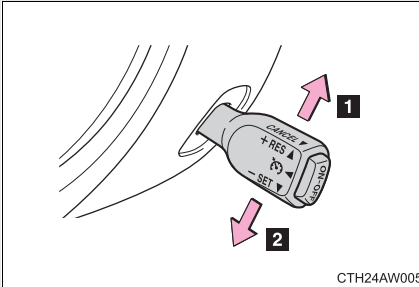

CTH24AW005

1 Increases the speed

2 Decreases the speed

Fine adjustment: Momentarily move the lever in the desired direction.

Large adjustment: Hold the lever in the desired direction.

The set speed will be increased or decreased as follows:

Fine adjustment (vehicles with a km/h odometer display): By approximately 1 km/h (0.6 mph) each time the lever is operated.

Fine adjustment (vehicles with an mph odometer display): By approximately 1.6 km/h (1 mph) each time the lever is operated.

Large adjustment: The set speed can be increased or decreased continually until the lever is released.

■ Canceling and resuming the constant speed control

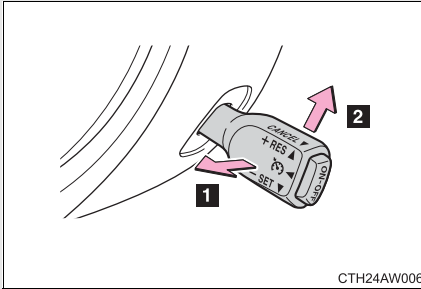

1 Pulling the lever toward you cancels the constant speed control.

The speed setting is also canceled when the brakes are applied or the clutch pedal (manual transmission only) is depressed.

2 Pushing the lever up resumes the constant speed control.

Resuming is available when the vehicle speed is more than approximately 32 km/h (20 mph).

■ Cruise control can be set when

Vehicles with an automatic transmission

- The shift lever is in D or M and the vehicle is in the 2nd gear or higher.
- Vehicle speed is above approximately 40 km/h (25 mph).

Vehicles with a manual transmission

- The vehicle is in the 2nd gear or higher.
- Vehicle speed is above approximately 40 km/h (25 mph).

■ Accelerating after setting the vehicle speed

- The vehicle can be accelerated normally. After acceleration, the set speed resumes.
- Even without canceling the cruise control, the set speed can be increased by first accelerating the vehicle to the desired speed and then pushing the lever down to set the new speed.

■ Automatic cruise control cancelation

Cruise control will stop maintaining the vehicle speed in any of the following situations.

- Actual vehicle speed is below approximately 32 km/h (20 mph).
- VSC is activated.

■ The system may be malfunctioning when

In the following situations, the system may be malfunctioning. Have the vehicle inspected by any authorized Toyota dealer or repairer, or another duly qualified and equipped professional.

- The cruise control indicator light comes on in yellow.
- The cruise control indicator does not come on even when the “ON-OFF” button is pressed while the engine is running.

 CAUTION

■ **To avoid operating the cruise control by mistake**

Switch the cruise control off using the “ON-OFF” button when not in use.

■ **Situations unsuitable for cruise control**

Do not use cruise control in any of the following situations.

Doing so may result in loss of control and could cause an accident resulting in death or serious injury.

- In heavy traffic
- On roads with sharp bends
- On winding roads
- On slippery roads, such as those covered with rain, ice or snow
- On steep hills
Vehicle speed may exceed the set speed when driving down a steep hill.
- During emergency towing

2-4. Using other driving systems

Driving assist systems

To help enhance driving safety and performance, the following systems operate automatically in response to various driving situations. Be aware, however, that these systems are supplementary and should not be relied upon too heavily when operating the vehicle.

■ ABS (Anti-lock Brake System)

Helps to prevent wheel lock when the brakes are applied suddenly, or if the brakes are applied while driving on a slippery road surface

■ Brake assist

Generates an increased level of braking force after the brake pedal is depressed when the system detects a panic stop situation

■ VSC (Vehicle Stability Control)

Helps the driver to control skidding when swerving suddenly or turning on slippery road surfaces

■ TRC (Traction Control)

Helps to maintain drive power and prevent the drive wheels from spinning when starting the vehicle or accelerating on slippery roads. The TRC system is also equipped with the brake LSD function.

■ EPS (Electric Power Steering)

Employs an electric motor to reduce the amount of effort needed to turn the steering wheel

When the TRC/VSC systems are operating

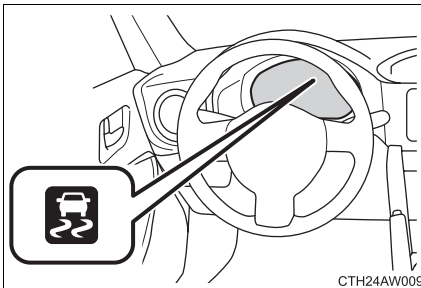

The slip indicator light will flash while the TRC (brake LSD function)/VSC systems are operating.

Disabling the TRC system

If the vehicle gets stuck in mud, dirt or snow, the TRC system may reduce power from the engine to the wheels. Pressing  to turn the system off may make it easier for you to rock the vehicle in order to free it.

In this case, the brake LSD function remains on.

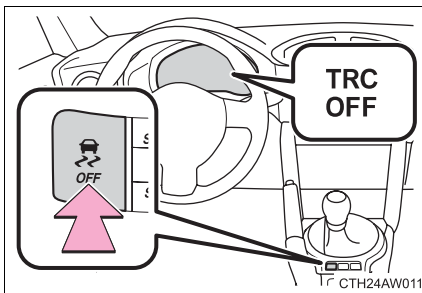

To turn the TRC system off, quickly press and release the button.

The "TRC OFF" indicator light will come on.

Press the button again to turn the system back on.

"VSC SPORT" mode

Your vehicle is equipped with two types of control modes to accommodate various driving preferences. The control modes can be selected with the "VSC SPORT" mode switch. Normal mode allows secure and smooth normal driving. When the switch is pressed, "VSC SPORT" mode is activated. Control characteristics such as the VSC and TRC are adjusted to afford maneuverability closer to what a driver may have imagined, while a sense of security is retained.

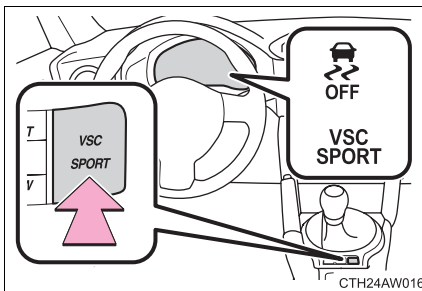



"VSC SPORT" mode/Normal mode

The "VSC SPORT" indicator and VSC off indicator come on when in "VSC SPORT" mode.

Selecting TRC mode and VSC mode

Modes can be selected to suit your driving conditions as follows:

Driving conditions	TRC modes	VSC modes	Indicator lights
Normal roads	On	Normal mode	—
Rough roads	Off	Normal mode	TRC OFF
Sport driving	On	“VSC SPORT” mode	 VSC SPORT
	Off	“VSC SPORT” mode	TRC OFF  VSC SPORT
	Off	Off	TRC OFF 

■ Turning off both TRC and VSC systems

To turn the TRC and VSC systems off, press and hold  for more than 3 seconds while the vehicle is stopped.

The “TRC OFF” indicator light and the VSC off indicator light will come on.

In this case, the brake LSD function remains on.

Press the button again to turn the systems back on.

■ Sounds and vibrations caused by the ABS, brake assist, TRC and VSC systems

- A sound may be heard from the engine compartment when the brake pedal is depressed repeatedly, when the engine is started or just after the vehicle begins to move. This sound does not indicate that a malfunction has occurred in any of these systems.
- Any of the following conditions may occur when the above systems are operating. None of these indicates that a malfunction has occurred.
 - Vibrations may be felt through the vehicle body and steering.
 - A motor sound may be heard after the vehicle comes to a stop.
 - The brake pedal may pulsate slightly after the ABS is activated.
 - The brake pedal may move down slightly after the ABS is activated.

■ EPS operation sound

When the steering wheel is operated, a motor sound (whirring sound) may be heard. This does not indicate a malfunction.

■ Automatic reactivation of TRC and VSC systems

After turning the TRC and VSC systems off, the systems will be automatically reactivated in the following situations:

- Vehicles without a smart entry & start system: When the engine switch is turned to “LOCK” position
- Vehicles with a smart entry & start system: When the “ENGINE START STOP” switch is turned off
- If only the TRC system is turned off, the TRC will turn on when vehicle speed is more than approximately 50 km/h (31 mph).
If both the TRC and VSC systems are turned off, automatic reactivation will not occur when vehicle speed increases.

■ Reduced effectiveness of the EPS system

The effectiveness of the EPS system is reduced to prevent the system from overheating when there is frequent steering input over an extended period of time. The steering wheel may feel heavy as a result. Should this occur, refrain from excessive steering input or stop the vehicle and turn the engine off. The EPS system should return to normal after a little while.

■ Automatic deactivation of “VSC SPORT” mode

Vehicles without a smart entry & start system

When the engine switch is turned to “LOCK” position after driving in “VSC SPORT” mode, the mode is automatically deactivated.

Vehicles with a smart entry & start system

When the “ENGINE START STOP” switch is turned off after driving in “VSC SPORT” mode, the mode is automatically deactivated.

CAUTION

■ The ABS does not operate effectively when

- Tires with inadequate gripping ability are used (such as excessively worn tires on a snow covered road).
- The vehicle hydroplanes while driving at high speed on wet or slick roads.

■ Stopping distance when the ABS is operating may exceed that of normal conditions

The ABS is not designed to shorten the vehicle’s stopping distance. Always maintain a safe distance from the vehicle in front of you in the following situations:

- When driving on dirt, gravel or snow-covered roads
- When driving with tire chains
- When driving over bumps in the road
- When driving over roads with potholes or uneven surfaces

■ TRC may not operate effectively when

Directional control and power may not be achievable while driving on slippery road surfaces, even if the TRC system is operating.
Do not drive the vehicle in conditions where stability and power may be lost.

 **CAUTION**

■ **When the VSC and/or brake LSD function is activated**

The slip indicator light flashes. Always drive carefully. Reckless driving may cause an accident. Exercise particular care when the indicator light flashes.

■ **When the TRC/VSC systems are turned off**

Be especially careful and drive at a speed appropriate to the road conditions. As these are the systems to help ensure vehicle stability and driving force, do not turn the TRC/VSC systems off unless necessary.

■ **Replacing tires**

Make sure that all tires are of the specified size, brand, tread pattern and total load capacity. In addition, make sure that the tires are inflated to the recommended tire inflation pressure level.

The ABS, TRC and VSC systems will not function correctly if different tires are installed on the vehicle.

Contact any authorized Toyota dealer or repairer, or another duly qualified and equipped professional for further information when replacing tires or wheels.

■ **Handling of tires and suspension**

Using tires with any kind of problem or modifying the suspension will affect the driving assist systems, and may cause a system to malfunction.

Cargo and luggage

Take notice of the following information about storage precautions, cargo capacity and load:

- Stow cargo and luggage in the trunk whenever possible.
- Be sure all items are secured in place.
- To maintain vehicle balance while driving, position luggage evenly within the luggage compartment.
- For better fuel economy, do not carry unnecessary weight.

 CAUTION

■ **Things that must not be carried in the trunk**

The following things may cause a fire if loaded in the trunk:

- Receptacles containing gasoline
- Aerosol cans

 CAUTION

■ **Storage precautions**

Observe the following precautions.

Failure to do so may result in death or serious injury.

- Stow cargo and luggage in the trunk whenever possible.
- To prevent cargo and luggage from sliding forward during braking, do not stack anything in the enlarged trunk. Keep cargo and luggage low, as close to the floor as possible.
- When you fold down the rear seats, long items should not be placed directly behind the front seats.
- Never allow anyone to ride in the enlarged trunk. It is not designed for passengers. They should ride in their seats with their seat belts properly fastened. Otherwise, they are much more likely to suffer death or serious bodily injury, in the event of sudden braking, sudden swerving or an accident.
- Do not place cargo or luggage in or on the following locations as the item may get under the clutch, brake or accelerator pedal and prevent the pedals from being depressed properly, block the driver's vision, or hit the driver or passengers, causing an accident:
 - At the feet of the driver
 - On the front passenger or rear seats (when stacking items)
 - On the package tray
 - On the instrument panel
 - On the dashboard
- Secure all items in the occupant compartment, as they may shift and injure someone during sudden braking, sudden swerving or an accident.

■ **Load and distribution**

- Do not overload your vehicle.
- Do not apply loads unevenly.
Improper loading may cause deterioration of steering or braking control which may cause death or serious injury.

2-5. Driving information

Winter driving tips

Carry out the necessary preparations and inspections before driving the vehicle in winter. Always drive the vehicle in a manner appropriate to the prevailing weather conditions.

■ Pre-winter preparations

- Use fluids that are appropriate to the prevailing outside temperatures.
 - Engine oil
 - Washer fluid
- Have a service technician inspect the condition of the battery.
- Have the vehicle fitted with four snow tires or purchase a set of tire chains for the rear tires.

Make sure to install 4 tires that are of the specified size, and that all 4 tires are the same size, same maker, same brand and tread pattern. Also, make sure to use tire chains that match the size of the tires.

■ Before driving the vehicle

Perform the following according to the driving conditions.

- Do not try to forcibly open a window or move a wiper that is frozen. Pour warm water over the frozen area to melt the ice. Wipe away the water immediately to prevent it from freezing.
- To ensure proper operation of the climate control system fan, remove any snow that has accumulated on the air inlet vents in front of the windshield.
- Check for and remove any excess ice or snow that may have accumulated on the exterior lights, vehicle's roof, chassis, around the tires or on the brakes.
- Remove any snow or mud from the bottom of your shoes before getting in the vehicle.

- If a door is opened and closed when its side window is frozen, the window safety device will operate and the side window open/close function linked to door operation may not operate correctly. If this occurs, perform the following after the ice has melted.

STEP 1 Open the side window until it is approximately halfway open with the door closed.

STEP 2 Fully close the window by pulling the switch up to the one-touch closing position and continue holding the switch for 1 second or more after the window fully closes.

The window position is reset and the safety device operations will be released.

■ **When driving the vehicle**

Accelerate the vehicle slowly, keep a safe distance between you and the vehicle ahead, and drive at a reduced speed suitable to road conditions.

■ **When parking the vehicle (in the winter time or in the cold latitudes)**

Park the vehicle and move the shift lever to P (automatic transmission) or 1 or R (manual transmission) without setting the parking brake. The parking brake may freeze up, preventing it from being released. If necessary, block the wheels to prevent inadvertent sliding or creeping.

Selecting tire chains

We recommend that you consult any authorized Toyota dealer or repairer, or another duly qualified and equipped professional for information about the chains that you can use.

Regulations on the use of tire chains

Regulations regarding the use of tire chains vary according to location and type of road. Always check local regulations before installing chains.

Tire chains

Observe the following precautions when installing and removing chains.

- Install and remove tire chains in a safe location.
- Install tire chains on the rear tires. Do not install tire chains on front tires.
- Install tire chains on rear tires as tightly as possible. Retighten chains after driving approximately 100 m (328 ft.).
- Install tire chains following the instructions provided with the tire chains.

CAUTION

Driving with snow tires

Observe the following precautions to reduce the risk of accidents. Failure to do so may result in a loss of vehicle control and cause death or serious injury.

- Use tires of the specified size, and that are the same size, same maker, same brand and tread pattern.
- Maintain the recommended level of air pressure.
- Do not drive at speeds in excess of the speed limit or the speed limit specified for the snow tires being used.
- Use snow tires on all, not just some wheels.

 CAUTION

■ **Driving with tire chains**

- Vehicles with an emergency tire puncture repair kit: When any of the tires are punctured, you can seal the tire temporarily. However, do not use the tire chain on a sealed tire. If any of the rear tires are punctured although it is required to use tire chains, contact any authorized Toyota dealer or repairer, or another duly qualified and equipped professional.
- Observe the following precautions to reduce the risk of accidents. Failing to do so may result in the vehicle being unable to be driven safely, and may cause death or serious injury.
 - Do not drive in excess of the speed limit specified for the tire chains being used, or 30 km/h (19 mph), whichever is lower.
 - Avoid driving on bumpy road surfaces or over potholes.
 - Avoid sudden acceleration, abrupt steering, sudden braking and shifting operations that cause sudden engine braking.
 - Slow down sufficiently before entering a curve to ensure that vehicle control is maintained.

Always use the utmost care when driving with tire chains - overconfidence because you are driving with tire chains could easily lead to a serious accident.

 NOTICE

■ **Using the tire chains**

Use only chains that are of the correct size for your tires so as not to damage the vehicle body or suspension.

■ **Repairing or replacing snow tires**

Request repairs or replacement of snow tires from Toyota dealers or legitimate tire retailers.

This is because the removal and attachment of snow tires affects the operation of the tire pressure warning valves and transmitters.

■ **Fitting tire chains**

The tire pressure warning valves and transmitters may not function correctly when tire chains are fitted.

2-5. Driving information

Trailer towing

Toyota does not recommend towing a trailer with your vehicle. Toyota also does not recommend the installation of a tow hitch or the use of a tow hitch carrier for a wheelchair, scooter, bicycle, etc. Your Toyota is not designed for trailer towing or for the use of tow hitch mounted carriers.



Interior features

3

3-1. Using the air conditioning system and defogger

Manual air conditioning system	240
Automatic air conditioning system	248
Rear window and outside rear view mirror defoggers	256

3-2. Using the audio system

Using the AUX/USB port	258
------------------------------	-----

3-3. Using the interior lights

Interior lights list.....	259
• Interior light.....	260

3-4. Using the storage features

List of storage features.....	261
• Glove box	262
• Bottle holders.....	263
• Cup holders/ console tray	264

3-5. Other interior features

Sun visors	266
Vanity mirrors.....	267
Clock.....	268
Outside temperature display	269
Ashtray.....	270
Power outlets	271
Seat heaters	273
Floor mat.....	275
Trunk features.....	278

3-1. Using the air conditioning system and defogger

Manual air conditioning system*

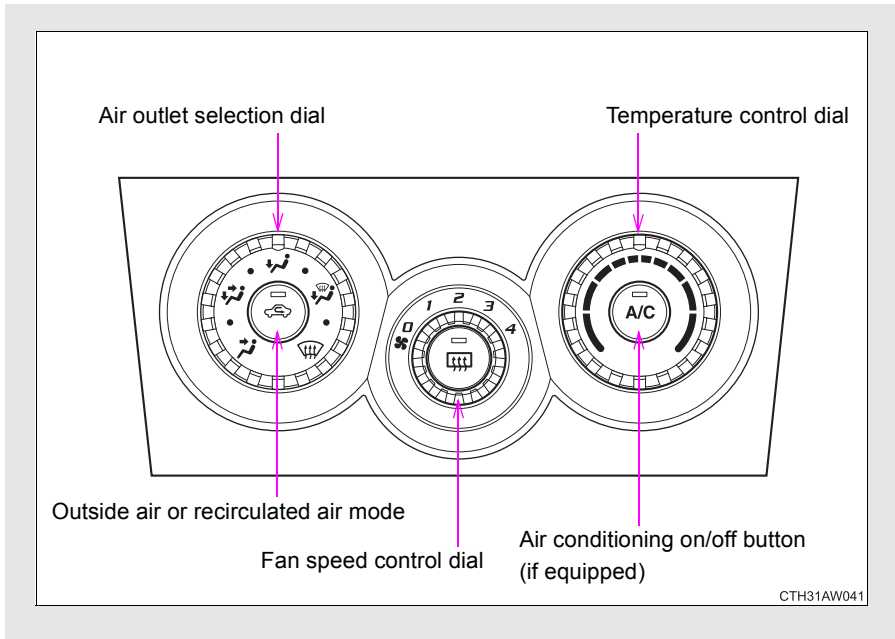



Adjusting the settings

STEP 1 To adjust the fan speed, turn the fan speed control dial clockwise (increase) or counterclockwise (decrease).
Turning the dial to “0” turns off the fan.

STEP 2 Vehicles without the  button: Turn the temperature control dial clockwise to increase the temperature.

*: If equipped

STEP 2 Vehicles with the  button: To adjust the temperature setting, turn the temperature control dial clockwise (warm) or counterclockwise (cool).

 is not pressed, the system will blow ambient temperature air or heated air.

STEP 3 To select the air outlets, set the air outlet selection dial to the desired position.

The positions between the air outlet selections shown below can also be selected for more delicate adjustment.

Defogging the windshield

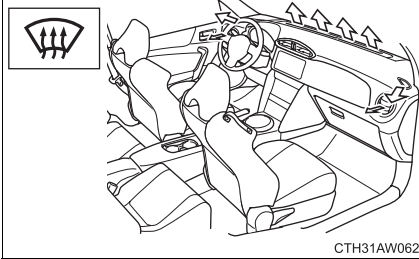

STEP 1



Set the air outlet selection dial to  position.

If the recirculated air mode is used, it will automatically switch to the outside air mode.

STEP 2 Perform the following operations accordingly:

- To adjust the fan speed, turn the fan speed control dial.
- To adjust the temperature setting, turn the temperature control dial.
- Vehicles with the  button: If the dehumidification function is not operating, press  to operate the dehumidification function.

To defog the windshield and the side windows early, turn the air flow and temperature up.

■ Air outlets and air flow

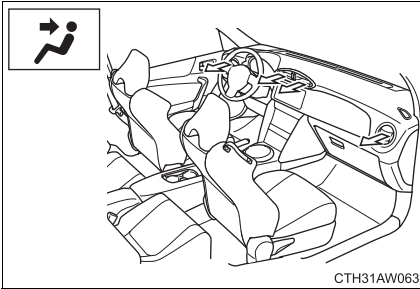

Air flows to the upper body.

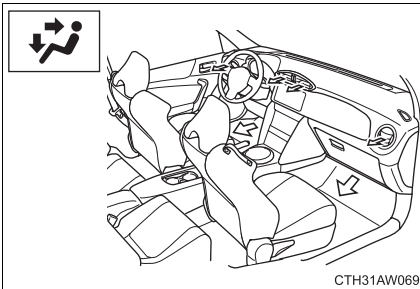

Air flows to the upper body and feet.

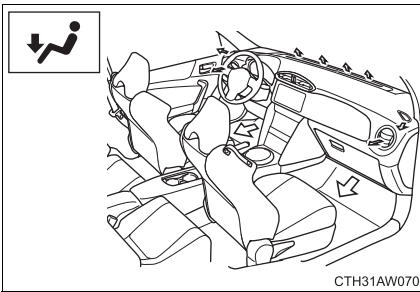

Air flows to the feet.

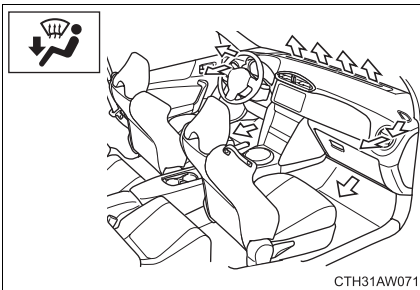

Air flows to the feet and the windshield defogger operates.

Switching between outside air and recirculated air modes

Press  .

The mode switches between outside air mode (introduces air from outside the vehicle) (indicator off) and recirculated air mode (recycles air inside the vehicle) (indicator on) each time the button is pressed.

Adjusting the position of the air outlets

Center outlets

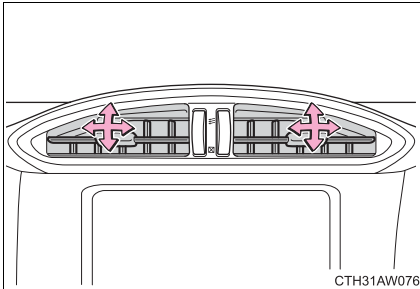

Direct air flow to the left or right, up or down.

Right and left side outlets

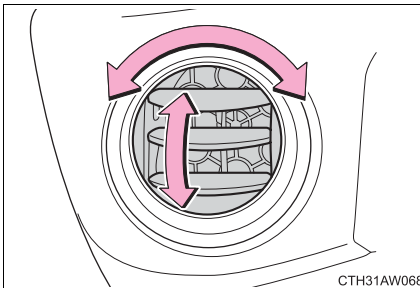

Direct air flow to the left or right, up or down.

When defrosting the side windows, face the right and left side outlets toward them.

Opening and closing the air outlets

Center outlets

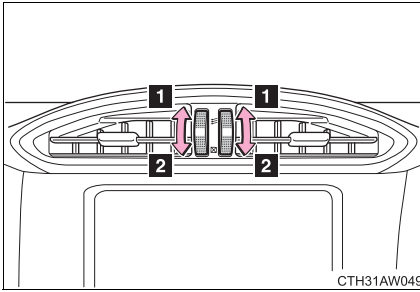



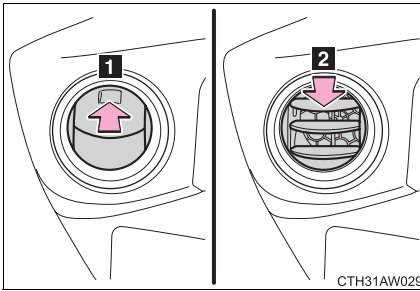

- 1** Open the air outlet.
- 2** Close the air outlet.

Right and left side outlets



- 1** Open the vent.
- 2** Close the vent.

■ **Fogging up of the windows**

- Vehicles with the  button: The windows will easily fog up when the humidity in the vehicle is high. Turning  on will dehumidify the air from the outlets and defog the windshield effectively.
- Vehicles with the  button: If you turn  off, the windows may fog up more easily.
- The windows may fog up if the recirculated air mode is used.

■ **Outside/recirculated air mode**

- When driving on dusty roads such as tunnels or in heavy traffic, set the outside/recirculated air mode button to the recirculated air mode. This is recommended to prevent outside air from entering the vehicle interior.
- Vehicles with the  button: During cooling operation, setting the recirculated air mode will also cool the vehicle interior effectively.

■ **When the outside temperature falls to nearly 0°C (32°F) (vehicles with the  button)**

The dehumidification function may not operate even when  is pressed.

■ Ventilation and air conditioning odors

- To let fresh air in, set the air conditioning system to the outside air mode.
- During use, various odors from inside and outside the vehicle may enter into and accumulate in the air conditioning system. This may then cause odor to be emitted from the vents.
- To reduce potential odors from occurring:
It is recommended that the air conditioning system be set to outside air mode prior to turning the vehicle off.

■ Air conditioning filter

→P. 329

CAUTION

■ To prevent the windshield from fogging up

Do not set the air outlet selection dial to  during cool air operation in extremely humid weather. The difference between the temperature of the outside air and that of the windshield can cause the outer surface of the windshield to fog up, blocking your vision.

NOTICE

■ To prevent battery discharge

Do not leave the air conditioning system on longer than necessary when the engine is stopped.

3-1. Using the air conditioning system and defogger

Automatic air conditioning system*

Air outlets are automatically selected and fan speed is automatically adjusted according to the set temperature setting.

The illustration below is for left-hand drive vehicles.

The button positions may differ slightly for right-hand drive vehicles.

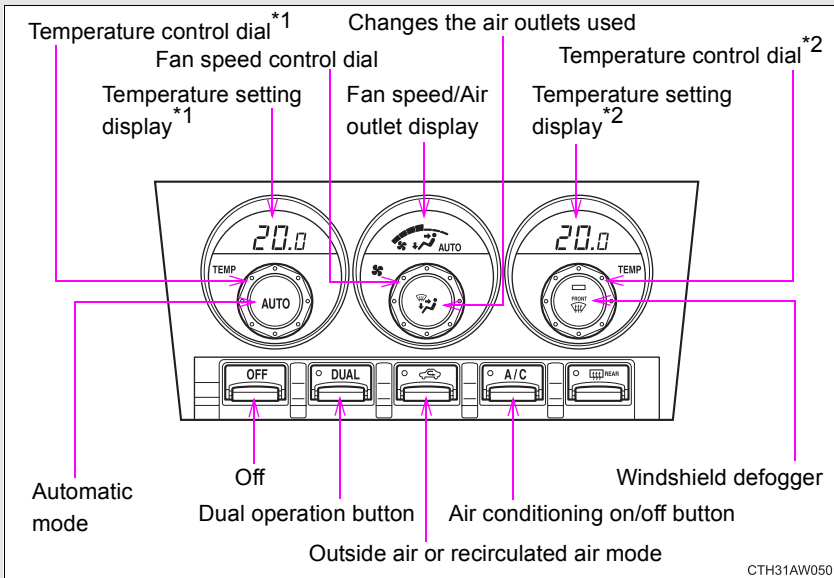

***1: Left-hand drive vehicles**

For the driver's side

Right-hand drive vehicles

For the front passenger's side

***2: Left-hand drive vehicles**

For the front passenger's side

Right-hand drive vehicles

For the driver's side

*: If equipped

Using the automatic air conditioning system



STEP 1 Press



The dehumidification function begins to operate. Air outlets and fan speed are automatically adjusted according to the temperature setting.

STEP 2

Turn temperature control dial clockwise to increase the temperature and turn temperature control dial counterclockwise to decrease the temperature on the driver's side.

When  is pressed (the indicator on  is on) or the passenger's side temperature control dial is turned, the temperature for the driver and passenger seats can be adjusted separately.

■ Automatic mode indicator

If the fan speed setting or air flow modes are operated, the automatic mode indicator goes off. However, automatic mode for functions other than that operated are maintained.



Adjusting the settings manually

STEP 1 To adjust the fan speed, turn the fan speed control dial clockwise (increase) or counter-clock wise (decrease).

Press  to turn the fan off.

STEP 2 To adjust the temperature settings, turn the temperature control dial clockwise (warm) or counter-clockwise (cool).

To adjust the temperature control dial clockwise (warm) or counter-clockwise (cool) on the passenger side to separately adjust the temperature for the passenger and driver sides (dual mode).

Press  (the indicator on  turns off) to return the driver and passenger side temperatures to the same setting (simultaneous mode).

The air conditioning system switches between dual and simultaneous modes each time  is pressed.

STEP 3 To change the air outlets, press .

The air outlets used are switched each time either side of the button is pressed.

Defogging the windshield

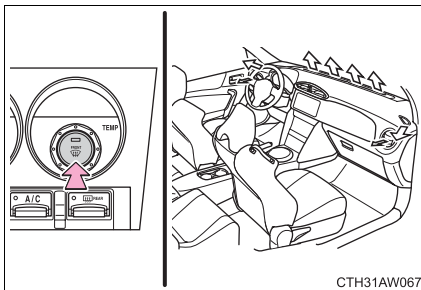

Press .

The dehumidification function operates and fan speed increases.

Set the outside/recirculated air mode button to outside air mode if the recirculated air mode is used. (It may switch automatically.)

To defog the windshield and the side windows early, turn the air flow and temperature up.

To return to the previous mode,

press  again when the windshield is defogged.

Air outlets and air flow

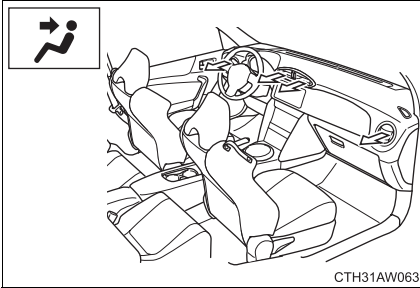

Air flows to the upper body.

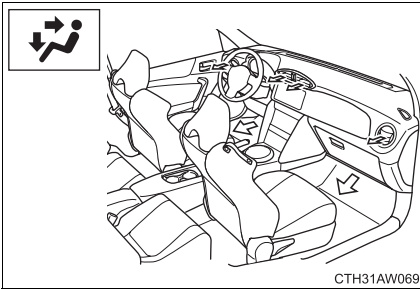

Air flows to the upper body and feet.

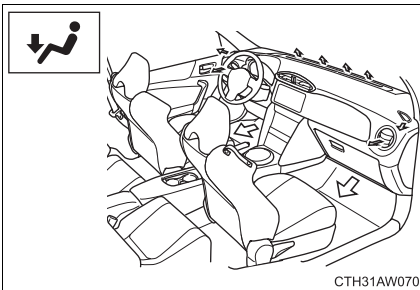

Air flows to the feet.

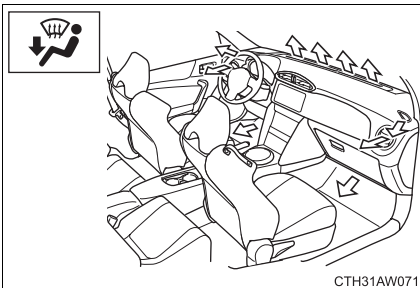

Air flows to the feet and the windshield defogger operates.

If the recirculated air mode is used, it may automatically switch to the outside air mode.

Switching between outside air mode and recirculated air mode

Press .

The mode switches between outside air mode (indicator off) and recirculated air mode (indicator on) each time  is pressed.

Adjusting the position of the air outlets

Center outlets

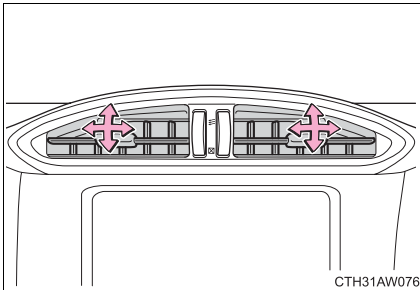

Direct air flow to the left or right, up or down.

Right and left side outlets

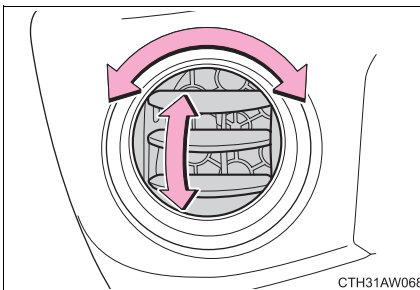

Direct air flow to the left or right, up or down.

When defrosting the side windows, face the right and left side outlets toward them.

Opening and closing the air outlets

Center outlets

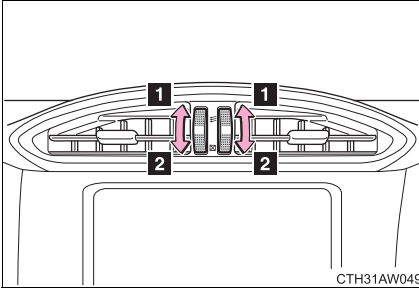

- 1** Open the air outlet.
- 2** Close the air outlet.

Right and left side outlets

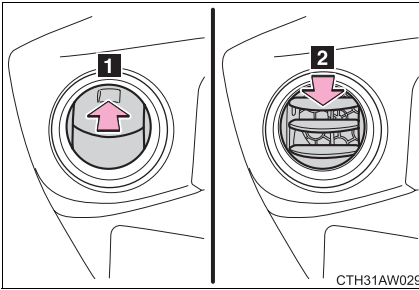

- 1** Open the vent.
- 2** Close the vent.

■ Using automatic mode

Fan speed is adjusted automatically according to the temperature setting and the ambient conditions.

Therefore, the fan may stop for a while until warm or cool air is ready to flow

immediately after  is pressed.

■ Fogging up of the windows

- The windows will easily fog up when the humidity in the vehicle is high.

Turning  on will dehumidify the air from the outlets and defog the windshield effectively.

- If you turn  off, the windows may fog up more easily.

- The windows may fog up if the recirculated air mode is used.

■ Outside/recirculated air mode

- When driving on dusty roads such as tunnels or in heavy traffic, set the outside/recirculated air mode button to the recirculated air mode. This is effective in preventing outside air from entering the vehicle interior. During cooling operation, setting the recirculated air mode will also cool the vehicle interior effectively.

- Outside/recirculated air mode may automatically switch depending on the temperature setting or the inside temperature.

■ When the outside temperature falls to nearly 0°C (32°F)

The dehumidification function may not operate even when  is pressed.

■ Ventilation and air conditioning odors

- To let fresh air in, set the air conditioning system to the outside air mode.
- During use, various odors from inside and outside the vehicle may enter into and accumulate in the air conditioning system. This may then cause odor to be emitted from the vents.
- To reduce potential odors from occurring:
 - It is recommended that the air conditioning system be set to outside air mode prior to turning the vehicle off.
 - The start timing of the blower may be delayed for a short period of time immediately after the air conditioning system is started in automatic mode.

■ Air conditioning filter

→P. 329

CAUTION

■ To prevent the windshield from fogging up

Do not use  during cool air operation in extremely humid weather. The difference between the temperature of the outside air and that of the windshield can cause the outer surface of the windshield to fog up, blocking your vision.

NOTICE

■ To prevent battery discharge

Do not leave the air conditioning system on longer than necessary when the engine is stopped.

3-1. Using the air conditioning system and defogger

Rear window and outside rear view mirror defoggers

The rear window defogger is used to defog the rear window. The outside rear view mirror defoggers* are used to remove frost, dew or raindrops from the outside rear view mirrors.

Vehicles with a manual air conditioning system

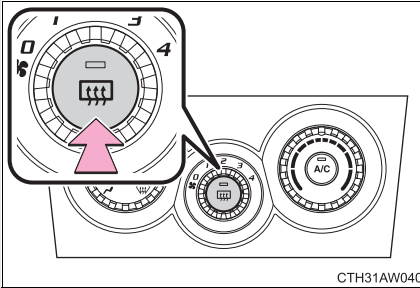

CTH31AW040

On/off

The defoggers will automatically turn off after approximately 15 minutes.

Vehicles with an automatic air conditioning system

The illustration below is for left-hand drive vehicles. The button positions may differ slightly for right-hand drive vehicles.

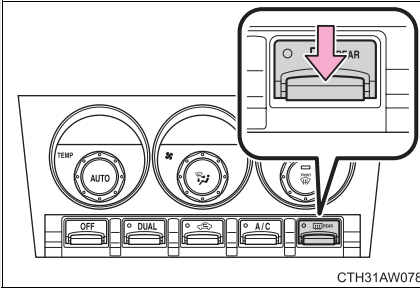

CTH31AW078

On/off

The defoggers will automatically turn off after approximately 15 minutes.

*: Vehicles with outside rear view mirror defoggers

■ The defoggers can be operated when

Vehicles without a smart entry & start system

The engine switch is in the “ON” position.

Vehicles with a smart entry & start system

The “ENGINE START STOP” switch is in IGNITION ON mode.

■ The outside rear view mirror defoggers (vehicles with outside rear view mirror defoggers)

Turning the rear window defogger on will turn the outside rear view mirror defoggers on.

■ When continuous operation is set (vehicles with an automatic air conditioning system)

During continuous operation, the defogger stops operating for 2 minutes after every 15 minutes of continual operation. Even during the 2 minutes that operation stops, the operating light remains illuminated. The rear window defogger will continue to operate in this cycle until it is turned off.

■ Customization that can be configured at any authorized Toyota dealer or repairer, or another duly qualified and equipped professional (vehicles with an automatic air conditioning system)

The rear window defogger can be set to 15-minute operation or continuous operation. (Customizable features →P. 449)

CAUTION

■ When the outside rear view mirror defoggers are on (vehicles with outside rear view mirror defoggers)

Do not touch the outside surface of the rear view mirrors, as they can become very hot and burn you.

NOTICE

■ To prevent battery discharge

Do not leave the rear window defogger on longer than necessary when the engine is stopped.

3-2. Using the audio system

Using the AUX/USB port*

This port can be used to connect a portable audio device and listen to it through the vehicle's speakers.

Depending on the type of portable audio device, some device operation may not be available.

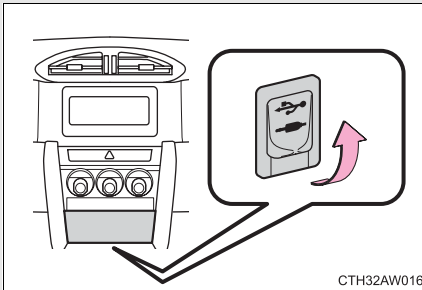

Open the cover and connect the portable audio device.

■ Operating portable audio devices connected to the audio system

The volume can be adjusted using the vehicle's audio controls. All other adjustments must be made on the portable audio device itself.

■ When using a portable audio device connected to the power outlet

Noise may occur during playback. Use the power source of the portable audio device.

*: If equipped

3-3. Using the interior lights

Interior lights list

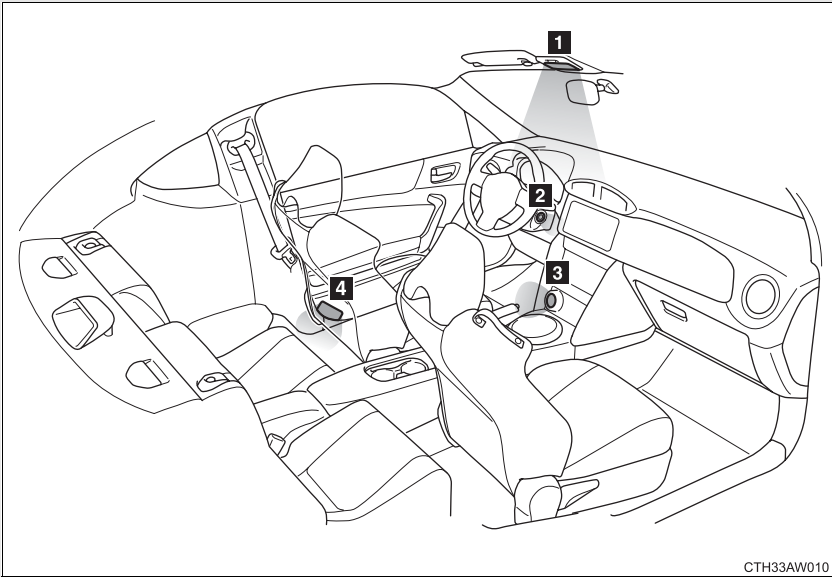

- 1** Interior light (→P. 260)
- 2** Engine switch light (vehicles without a smart entry & start system)
- 3** “ENGINE START STOP” switch light (vehicles with a smart entry & start system)
- 4** Door courtesy lights (if equipped)

Interior light

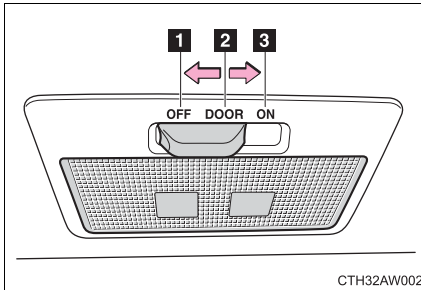

- 1** Turns the light off
- 2** Turns the door position on
- 3** Turns the light on

■ Illuminated entry system

Vehicles without a smart entry & start system

The lights automatically turn on/off according to the engine switch position, whether the doors are locked/unlocked, and whether the doors are open/closed.

Vehicles with a smart entry & start system

The lights automatically turn on/off according to “ENGINE START STOP” switch mode, the presence of the electronic key, whether the doors are locked/unlocked, and whether the doors are open/closed.

■ To prevent battery discharge

If the following lights remain on when the door is not fully closed, the lights will go off automatically after 20 minutes:

- Interior light (when the switch is in the “DOOR” position)
- Engine switch light (vehicles without a smart entry & start system)
- “ENGINE START STOP” switch light (vehicles with a smart entry & start system)
- Door courtesy lights (if equipped)

■ Customization that can be configured at any authorized Toyota dealer or repairer, or another duly qualified and equipped professional

Settings (e.g. the time elapsed before lights turn off) can be changed.
(Customizable features →P. 449)

3-4. Using the storage features

List of storage features

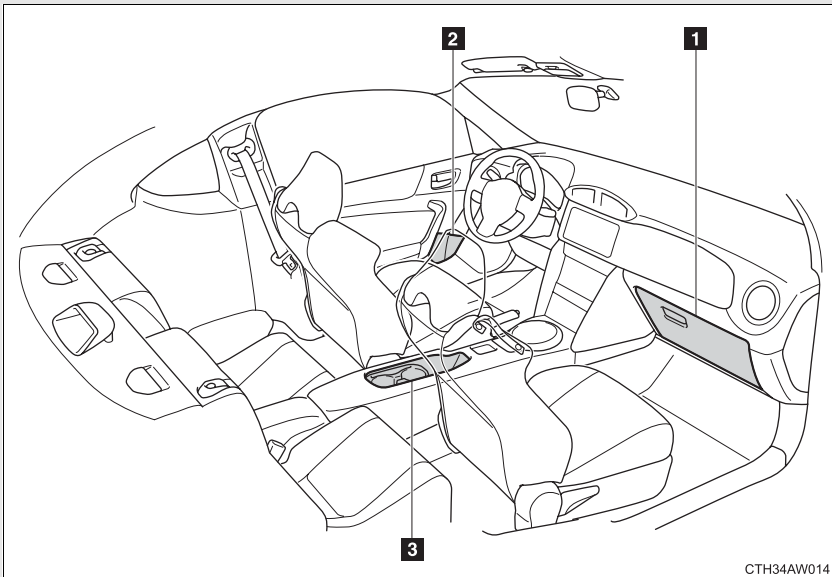

- 1** Glove box
- 2** Bottle holders
- 3** Cup holders (if equipped)/console tray

CAUTION

■ Items that should not be left in the storage spaces

Do not leave glasses, lighters or spray cans in the storage spaces, as this may cause the following when cabin temperature becomes high:

- Glasses may be deformed by heat or cracked if they come into contact with other stored items.
- Lighters or spray cans may explode. If they come into contact with other stored items, the lighter may catch fire or the spray can may release gas, causing a fire hazard.

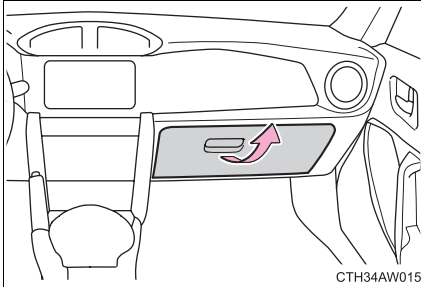
Glove box

Pull up the lever to open the glove box.

⚠ CAUTION**■ Caution while driving**

Keep the glove box closed. In the event of sudden braking or sudden swerving, an accident may occur due to an occupant being struck by the open glove box or the items stored inside.

Bottle holders

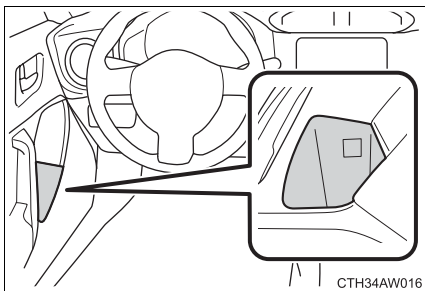

■ When using the bottle holder

- When storing a bottle, close the cap.
- The bottle may not be stored depending on its size or shape.

⚠ CAUTION

■ Items unsuitable for the bottle holder

Do not place anything other than a pet bottle in the bottle holders. Other items may be thrown out of the holders in the event of an accident or sudden braking and cause injury.

⚠ NOTICE

■ Items unsuitable for the bottle holder

Put the cap on before stowing a bottle. Do not place open bottles in the bottle holders, or glasses and paper cups containing liquid. The contents may spill and glasses may break.

Cup holders (if equipped)/console tray

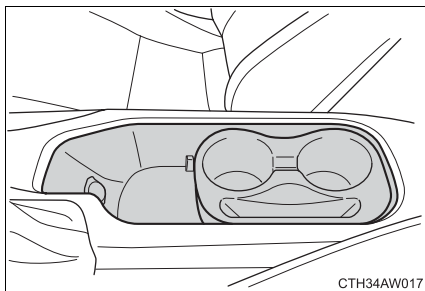

■ Changing the cup holder position

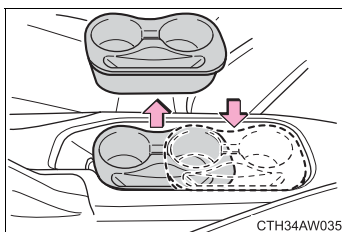

Remove the cup holder and change the holder position.

■ Changing the console tray size

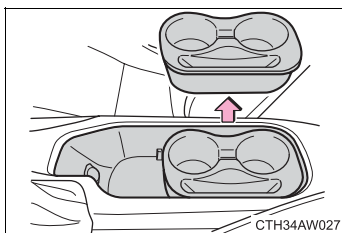

Remove the cup holder.

⚠ CAUTION**■ Caution while driving**

Observe the following precautions.

Failure to do so may cause an accident resulting in death or serious injury.

- Before driving, place the cup holder in the rear position so that it does not hinder shift lever operation.

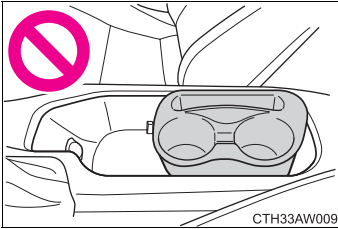

- When placing the cup holder, make sure it is facing the correct direction. Failure to do so will cause the cup holder to not be secure in the console tray and hinder shift lever operation.

■ Items unsuitable for the cup holder

Do not place anything other than cups or aluminum cans in the cup holders. Other items may be thrown out of the holders in the event of an accident or sudden braking, causing injury. If possible, cover hot drinks to prevent burns.

3-5. Other interior features

Sun visors

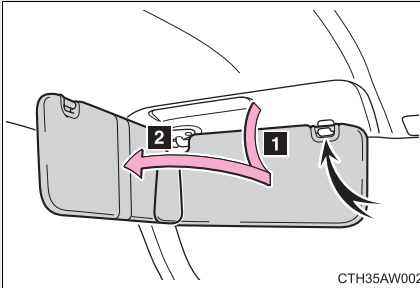

- 1** To set the visor in the forward position, flip it down.
- 2** To set the visor in the side position, flip down, unhook, and swing it to the side.

3-5. Other interior features

Vanity mirrors*

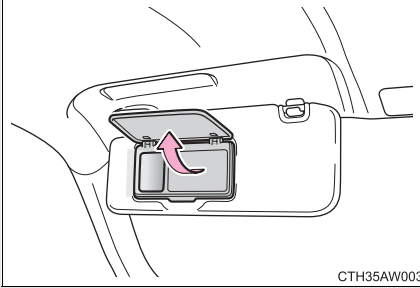

Open the cover to use.

Vehicles with vanity lights: The light turns on when the cover is opened.

NOTICE

To prevent battery discharge (vehicles with vanity lights)

Do not leave the vanity lights on for extended periods while the engine is off.

3-5. Other interior features

Clock

The clock can be adjusted by pressing the buttons.

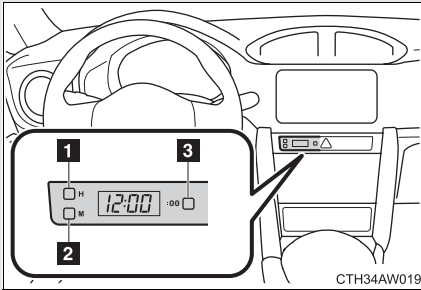

- 1** Adjusts the hours
- 2** Adjusts the minutes
- 3** Rounds to the nearest hour*

*: e.g. 1:00 to 1:29 → 1:00
1:30 to 1:59 → 2:00

■ The clock is displayed when

Vehicles without a smart entry & start system

The engine switch is in the “ACC” or “ON” position.

Vehicles with a smart entry & start system

The “ENGINE START STOP” switch is in ACCESSORY or IGNITION ON mode.

■ When disconnecting and reconnecting battery terminals

The clock data will be reset.

3-5. Other interior features

Outside temperature display

The temperature display shows temperatures within the range of -40°C (-40°F) and 50°C (122°F).

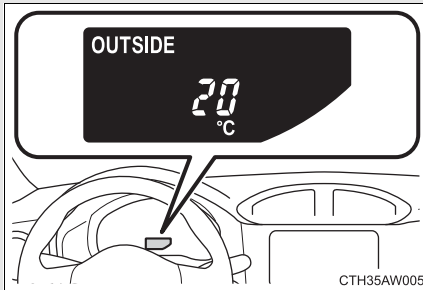

The outside temperature display can be switched by pressing the “DISP” switch. (→P. 204)

■ The outside temperature is displayed when

Vehicles without a smart entry & start system

The engine switch is in the “ON” position.

Vehicles with a smart entry & start system

The “ENGINE START STOP” switch is in IGNITION ON mode.

■ Display

In the following situations, the correct outside temperature may not be displayed, or the display may take longer than normal to change:

- When the vehicle is stopped, or moving at low speeds (less than 20 km/h [12 mph])
- When the outside temperature has changed suddenly (at the entrance/exit of a garage, tunnel, etc.)

■ When “- -” is displayed more than 1 minute or the outside temperature is not displayed

The system may be malfunctioning. Take your vehicle to any authorized Toyota dealer or repairer, or another duly qualified and equipped professional.

3-5. Other interior features

Ashtray*

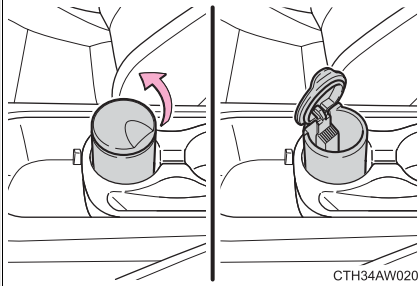

The ashtray can be installed in the cup holder. (→P. 264)

CAUTION

■ When not in use

Keep the ashtray closed. In the event of sudden braking, an accident may occur due to an occupant being struck by the open ashtray or ash flying out.

■ To prevent fire

- Fully extinguish matches and cigarettes before putting them in the ashtray, then make sure the ashtray is fully closed.
- Do not place paper or any other type of flammable object in the ashtray.

*: If equipped

3-5. Other interior features

Power outlets

The power outlet can be used for 12 V accessories that run on 10 A or less.

In the console tray

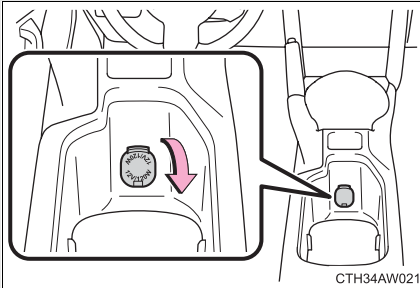

In the glove box (if equipped)

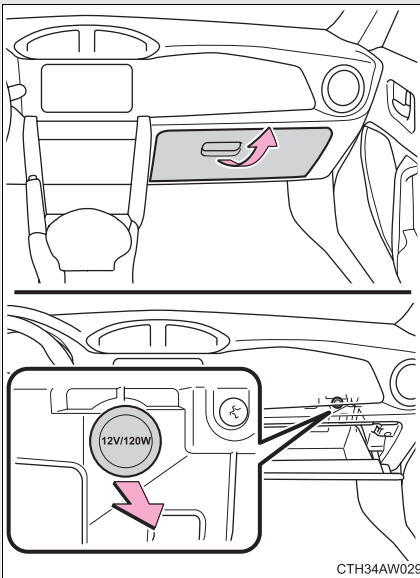

■ **The power outlet can be used when**

Vehicles without a smart entry & start system

The engine switch is in the “ACC” or “ON” position.

Vehicles with a smart entry & start system

The “ENGINE START STOP” switch is in ACCESSORY or IGNITION ON mode.



NOTICE

■ **To avoid damaging the power outlet**

Close the power outlet lid when the power outlet is not in use.

Foreign objects or liquids that enter the power outlet may cause a short circuit.

■ **To prevent the fuse from being blown**

Do not use an accessory that uses more than 12 V 10 A.

■ **To prevent battery discharge**

Do not use the power outlet longer than necessary when the engine is not running.

3-5. Other interior features

Seat heaters*

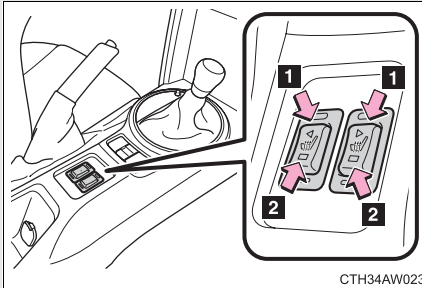

Press the switch to warm the seats.

The indicator light comes on when a seat heater is turned on.

- 1** Rapid heating
- 2** Normal heating

■ The seat heaters can be used when

The “ENGINE START STOP” switch is in IGNITION ON mode.

■ When not in use

Turn the seat heater off. The indicator light goes off.

⚠ CAUTION

■ Burns

- Use caution when seating the following persons in a seat with the seat heater on to avoid the possibility of burns:
 - Babies, small children, the elderly, the sick and the physically challenged
 - Persons with sensitive skin
 - Persons who are fatigued
 - Persons who have taken alcohol or drugs that induce sleep (sleeping drugs, cold remedies, etc.)
- Do not cover the seat with anything when using the seat heater. Using the seat heater with a blanket or cushion increases the temperature of the seat and may lead to overheating.
- Do not use the seat heater more than necessary. Doing so may cause minor burns or overheating.

*: If equipped



NOTICE

■ **To prevent seat heater damage**

Do not put heavy objects that have an uneven surface on the seat and do not stick sharp objects (needles, nails, etc.) into the seat.

■ **To prevent battery discharge**

Turn the seat heaters off when the engine is not running.

3-5. Other interior features

Floor mat

Use only floor mats designed specifically for vehicles of the same model and model year as your vehicle. Fix them securely in place onto the carpet.

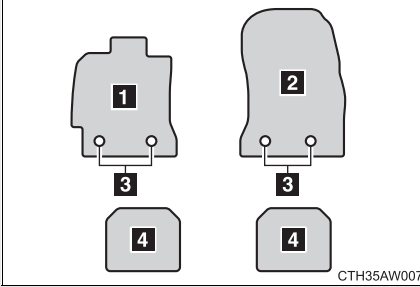

Front

- 1 Driver's seat floor mat
- 2 Front passenger's seat floor mat
- 3 Retaining hook (clip) eye-lets

Rear

- 4 Rear seat floor mats

■ Installing the floor mats (front)

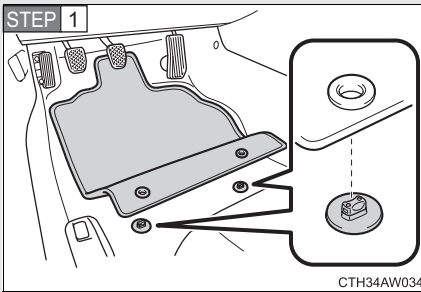

Insert the retaining hooks (clips) into the floor mat eye-lets.

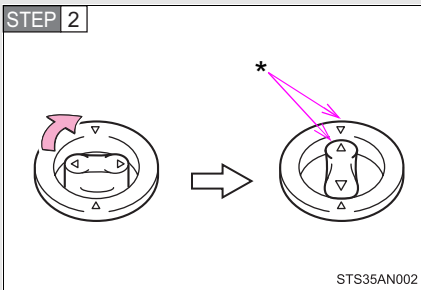

Turn the upper knob of each retaining hook (clip) to secure the floor mats in place.

*: Always align the Δ marks.

The shape of the retaining hooks (clips) may differ from that shown in the illustration.

⚠ CAUTION

Observe the following precautions.

Failure to do so may cause the driver's floor mat to slip, possibly interfering with the pedals while driving. An unexpectedly high speed may result or it may become difficult to stop the vehicle. This could lead to an accident, resulting in death or serious injury.

■ When installing a floor mat

- Do not use floor mats designed for other models or different model year vehicles, even if they are Toyota Genuine floor mats.
- Driver's seat floor mat: Only use floor mats designed for the driver's seat.
- Front: Always install the floor mat securely using the retaining hooks (clips) provided.
- Do not use two or more floor mats on top of each other.
- Do not place the floor mat bottom-side up or upside-down.

■ Before driving

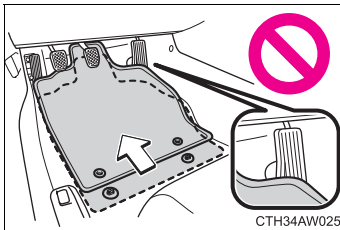

- Front: Check that the floor mat is securely fixed in the correct place with all the provided retaining hooks (clips). Be especially careful to perform this check after cleaning the floor.
- Driver's seat: With the engine stopped and the shift lever in P (automatic transmission) or N (manual transmission), fully depress each pedal to the floor to make sure it does not interfere with the floor mat.

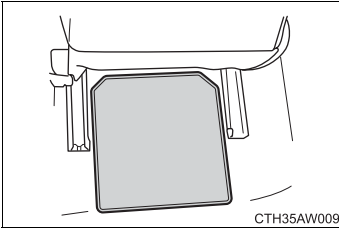
**NOTICE****■ When installing the rear floor mats**

Make sure that the rear floor mats are installed in the correct position. If a floor mat is positioned incorrectly, it may interfere with the seat rail or other parts when a front seat is moved forward or backward, damaging the vehicle or floor mat.

3-5. Other interior features

Trunk features (vehicles with an emergency tire puncture repair kit)

■ Auxiliary box

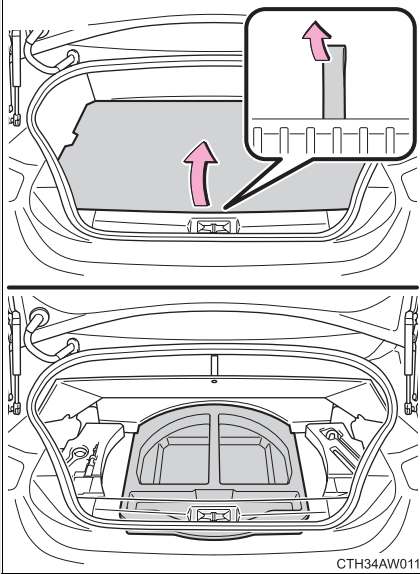

Vehicles with a luggage mat:
Lift up the luggage mat.

■ Warning reflector storage box

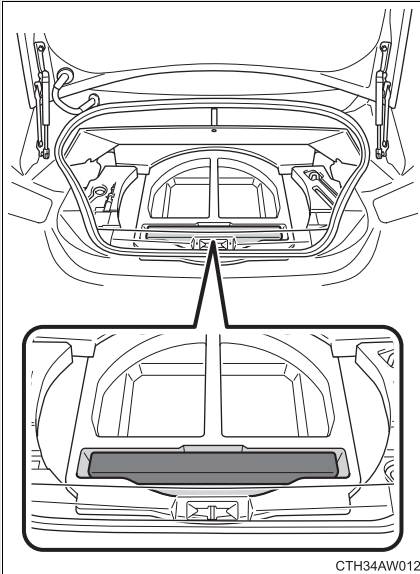

The warning reflector can be stored.

■ Warning reflector storage box

Depending on the size and shape of the warning reflector case, it may not be able to be stored.

⚠ CAUTION

■ When storing a warning reflector

Make sure that the warning reflector is stored securely. Failure to do so may cause it jump out of position in the event of sudden braking, etc., causing an accident.

4-1. Maintenance and care

- Cleaning and protecting the vehicle exterior 282
- Cleaning and protecting the vehicle interior 286
- Cleaning and protecting the Alcantara® area 290

4-2. Maintenance

- Maintenance requirements..... 292

4-3. Do-it-yourself maintenance

- Do-it-yourself service precautions 295
- Hood 298
- Positioning a floor jack..... 300
- Engine compartment..... 302
- Tires..... 315
- Tire inflation pressure 324
- Wheels..... 326
- Air conditioning filter 329
- Wireless remote control/ electronic key battery..... 332
- Checking and replacing fuses 336
- Light bulbs 344

Cleaning and protecting the vehicle exterior

Perform the following to protect the vehicle and maintain it in prime condition.

- Working from top to bottom, liberally apply water to the vehicle body, wheel wells and underside of the vehicle to remove any dirt and dust.
- Wash the vehicle body using a sponge or soft cloth, such as a chamois.
- For hard-to-remove marks, use car wash soap and rinse thoroughly with water.
- Wipe away any water.
- Wax the vehicle when the waterproof coating deteriorates.

If water does not bead on a clean surface, apply wax when the vehicle body is cool.

■ Automatic car washes

- Fold the mirrors before washing the vehicle. Start washing from the front of the vehicle. Make sure to extend the mirrors before driving.
- Brushes used in automatic car washes may scratch the vehicle surface and harm your vehicle's paint.
- Vehicles with a rear spoiler: In certain automatic car washes, the rear spoiler may interfere with machine operation. This may prevent the vehicle from being cleaned properly or result in damage to the rear spoiler.

■ High pressure car washes

- Do not allow the nozzles of the car wash to come within close proximity of the windows.
- Before car wash, check that the fuel filler door on your vehicle is closed properly.

■ Aluminum wheels

- Remove any dirt immediately by using a neutral detergent. Do not use hard brushes or abrasive cleaners. Do not use strong or harsh chemical cleaners. Use the same mild detergent and wax as used on the paint.
- Do not use detergent on the wheels when they are hot, for example after driving for long distance in the hot weather.
- Wash detergent from the wheels immediately after use.

■ Parts containing resin such as the bumper

Do not scrub with abrasive cleaners.

⚠ CAUTION**■ When washing the vehicle**

Do not apply water to the inside of the engine compartment. Doing so may cause the electrical components etc. to catch fire.

■ Precautions regarding the exhaust pipes

Exhaust gasses cause the exhaust pipes and rear bumper diffusers to become quite hot.

When washing the vehicle, be careful not to touch the pipes and diffusers until they have cooled sufficiently, as touching hot exhaust pipes and rear bumper diffusers can cause burns.



NOTICE

■ To prevent paint deterioration and corrosion on the body and components (aluminum wheels etc.)

● Wash the vehicle immediately in the following cases:

- After driving near the sea coast
- After driving on salted roads
- If you see coal tar or tree sap on the paint surface
- If you see dead insects, insect droppings or bird droppings on the paint
- After driving in an area contaminated with soot, oily smoke, mine dust, iron powder or chemical substances
- If the vehicle becomes heavily soiled in dust or mud
- If liquids such as benzene and gasoline are spilled on the paint surface

● If the paint is chipped or scratched, have it repaired immediately.

● To prevent the wheels from corroding, remove any dirt and store in a place with low humidity when storing the wheels.

■ Protective film for side sill plates (if equipped)

Make sure to remove the protective film. Failure to do so may cause rust, depending on conditions.

■ Cleaning the exterior lights

● Wash carefully. Do not use organic substances or scrub with a hard brush. This may damage the surfaces of the lights.

● Do not apply wax on the surfaces of the lights. Wax may cause damage to the lenses.

■ To prevent damage to the windshield wiper arms

When lifting the wiper arms away from the windshield, pull the driver side wiper arm upward first, and repeat for the passenger side. When returning the wipers to their original position, do so from the passenger side first.

**NOTICE****■ When using a high pressure car wash**

Do not bring the nozzle tip close to following parts and boots (Rubber or resin manufactured cover), or connectors. Parts may be damaged if they come into contact with high pressure water.

- Traction related parts
- Steering parts
- Suspension parts
- Brake parts

Cleaning and protecting the vehicle interior

The following procedures will help protect your vehicle's interior and keep it in top condition:

■ Protecting the vehicle interior

- Remove dirt and dust using a vacuum cleaner. Wipe dirty surfaces with a cloth dampened with lukewarm water.
- When the interior is extremely dirty, wipe away the dirt using a soft cloth slightly dampened with diluted neutral detergent.

■ Cleaning the leather areas

- Remove dirt and dust using a vacuum cleaner.
- Wipe any excess dirt and dust with a soft cloth dampened with diluted detergent.

Use a diluted water solution of approximately 5% neutral wool detergent.

- Wring out any excess water from the cloth and thoroughly wipe off all remaining traces of detergent.
- Wipe the surface with a dry, soft cloth to remove any remaining moisture. Allow the leather to dry in a shaded ventilated area.

■ Cleaning the synthetic leather areas

- Remove loose dirt using a vacuum cleaner.
- Apply a mild soap solution to the synthetic leather.
- Allow the solution to soak in for a few minutes. Remove the dirt and wipe off the solution with a clean, damp cloth.

■ Caring for leather areas

Toyota recommends cleaning the interior of the vehicle at least twice a year to maintain the quality of the vehicle's interior.

■ Shampooing the carpets

There are several commercial foaming-type cleaners available. Use a sponge or brush to apply the foam. Rub in overlapping circles. Do not apply water. Excellent results are obtained by keeping the carpet as dry as possible.

■ Seat belts

Clean with mild soap and lukewarm water using a cloth or sponge. Also check the belts periodically for excessive wear, fraying or cuts.

CAUTION

■ Water in the vehicle

- Do not splash or spill liquid in the vehicle.
Doing so may cause electrical components etc. to malfunction or catch fire.
- Do not get any of the SRS components or wiring in the vehicle interior wet.
(→P. 110)
Electrical malfunction may cause the airbags to deploy or not function properly, resulting in death or severe injury.

■ Cleaning the interior (especially instrument panel)

Do not use polish wax or polish cleaner. The instrument panel may reflect off the windshield, obstructing the driver's view and leading to an accident, resulting in death or serious injury.



NOTICE

■ Cleaning detergents

- Do not use organic substances such as benzene or gasoline, acidic or alkaline solutions, dye, bleach or other detergent. Doing so may discolor the vehicle interior or cause streaks or damage to painted surfaces.
- Do not use polish wax or polish cleaner. The instrument panel's or other interior part's painted surface may be damaged.
- Do not use a chemical agent containing silicone (highly-polymerized silicon compound) when cleaning any of the electrical appliances such as the air conditioning, all switches and their surrounding areas.
If silicon (highly-polymerized silicon compound) contacts these components, it may cause the electrical appliances to malfunction.

■ Preventing damage to leather surfaces

Observe the following precautions to avoid damage to and deterioration of leather surfaces.

- Remove any dust, dirt, sand, oil spots etc. on leather surfaces immediately.
- Do not expose the vehicle to direct sunlight for extended periods of time. Park the vehicle in the shade, especially during summer.
- Do not place items made of vinyl, plastic, or that contain wax on the upholstery, as they may stick to the leather surface if the vehicle interior heats up significantly.

■ Water on the floor

Do not wash the vehicle floor with water.

Vehicle systems such as the audio system may be damaged if water comes into contact with electrical components under the floor of the vehicle, and may also cause the body to rust.

**NOTICE****■ Cleaning the inside of the rear window**

- Be careful not to scratch or damage the heater wires.
- Do not use glass cleaner to clean the rear window, as this may cause damage to the rear window defogger heater wires. Use a cloth dampened with lukewarm water to gently wipe the window clean. Wipe the window in strokes running parallel to the heater wires.

■ When cleaning the instrument panel

When small grains of sand and so forth have gotten into instrument panel's surface and cannot be wiped away using a cloth, use a clay bar without adding water. Forcibly trying to wipe the surface clean with a brush or sponge may scratch the surface or fragments of the cloth may be left in the surface.

Cleaning and protecting the Alcantara® area*

The following procedures will protect and keep your vehicle's Alcantara® upholstery in top condition:

■ Day-to-day cleaning

Perform the following procedures regularly (approximately once a month).

STEP 1 Wipe the entire Alcantara® area with a soft cloth that has been dampened with lukewarm water (approximately 40°C [104°F]) and squeezed out.

Do not wipe too hard. Doing so may make the Alcantara® upholstery surface become uneven. Also, only use a clean cloth.

STEP 2 Once dry, brush the area with a soft brush.

■ Liquid stains

- If liquid is spilled, lightly pat the area with a tissue paper or similar to soak up the liquid.
- When mud, coffee, etc., has dried on the Alcantara® upholstery, remove it by lightly brushing the area with a soft brush or similar.

We recommend using a vacuum cleaner to clean up the area after the above has been performed.

When a stain cannot be removed using the above procedures, remove it by performing the following:

STEP 1 Lightly wipe the stained area from the outside to the inside from multiple angles with a soft cloth that has been dampened with lukewarm water (approximately 40°C [104°F]) and squeezed out.

Do not wipe the area so strongly that it causes the Alcantara® upholstery surface to become uneven. Also, prepare a clean cloth, and always use a clean area of the cloth.

*: If equipped

STEP 2 If the Alcantara® upholstery surface becomes uneven, lightly brush it with a soft brush.

STEP 3 Allow the surface to dry completely.

■ Oil stains

You will need the following items:

- A cloth that has been dampened with benzene
- A dry cloth

STEP 1 Using a dry cloth or tissue paper, wipe away as much of the oil as possible to prevent the stained area from expanding.

STEP 2 After patting the area from the outside to the inside from multiple angles using the cloth dampened with benzene, soak up the oil and benzene that floats up by patting the area with a dry cloth.

STEP 3 If the Alcantara® upholstery surface becomes uneven, lightly brush it with a soft brush.

■ When removing dirt or dust from the Alcantara® areas

Remove dirt or dust from the Alcantara® areas by lightly brushing with a soft brush. If this does not remove the dirt or dust, remove it using adhesive tape.

NOTICE

■ When soaking up spilled liquids

Do not press down too firmly with the cloth, tissue paper etc., as doing so may cause the liquid to further penetrate the material, making soaking up the liquid more difficult.

Maintenance requirements

To ensure safe and economical driving, day-to-day care and regular maintenance is essential. Toyota recommends the following maintenance.

■ Scheduled maintenance

Scheduled maintenance be performed at specified intervals according to the maintenance schedule.

For full details of your maintenance schedule, read the “Toyota Service Booklet” or “Toyota Warranty Booklet”.

■ Do-it-yourself maintenance

What about do-it-yourself maintenance?

Many maintenance items are easy to do yourself if you have a little mechanical ability and a few basic automotive tools.

Note, however, that some maintenance tasks require special tools and skills. These are best performed by qualified technicians. Even if you're an experienced do-it-yourself mechanic, we recommend that repairs and maintenance be conducted by any authorized Toyota dealer or repairer, or another duly qualified and equipped professional. Any authorized Toyota dealer or repairer will keep a record of maintenance, which could be useful should you ever require Warranty Service. Should you choose to select a qualified and equipped professional other than an authorized Toyota repairer to service or maintain your vehicle, we recommend that you request that a record of maintenance be kept.

■ Where to go for maintenance service?

In order to maintain your vehicle in the highest possible condition, Toyota recommends that all repairs and service operations be carried out by authorized Toyota dealers or repairers or other duly qualified and equipped professionals. For repairs and services covered by your warranty, please visit an authorized Toyota dealer or repairer, who will use genuine Toyota parts in repairing any difficulties you may encounter. There can also be advantages in utilizing authorized Toyota dealers or repairers for non-warranty repairs and services, as members of the Toyota network will be able to expertly assist you with any difficulties you may encounter.

Your Toyota dealer or repairer, or another duly qualified and equipped professional service department will perform all of the scheduled maintenance on your vehicle - reliably and economically due to their experience with Toyota vehicles.

■ Does your vehicle need repairs?

Be on the alert for changes in performance and sounds, and visual tip-offs that indicate service is needed. Some important clues are:

- Engine missing, stumbling or pinging
- Appreciable loss of power
- Strange engine noises
- A fluid leak under the vehicle (However, water dripping from the air conditioning system after use is normal.)
- Change in exhaust sound (This may indicate a dangerous carbon monoxide leak. Drive with the windows open and have the exhaust system checked immediately.)
- Flat-looking tires, excessive tire squeal when cornering, uneven tire wear
- Vehicle pulls to one side when driven straight on a level road
- Strange noises related to suspension movement
- Loss of brake effectiveness, spongy feeling brake pedal or clutch pedal, pedal almost touches the floor, vehicle pulls to one side when braking
- Engine coolant temperature continually higher than normal

If you notice any of these clues, take your vehicle to any authorized Toyota dealer or repairer, or another duly qualified and equipped professional as soon as possible. Your vehicle may need adjustment or repair.



CAUTION

■ **If your vehicle is not properly maintained**

It could result in serious damage to the vehicle and possible serious injury or death.

■ **Warning in handling of the battery**

Battery posts, terminals and related accessories contain lead and lead compounds which are known to cause brain damage. Wash your hands after handling. (→P. 309)

4-3. Do-it-yourself maintenance

Do-it-yourself service precautions

If you perform maintenance yourself, be sure to follow the correct procedures as given in these sections.

Items	Parts and tools
Battery condition (→P. 309)	<ul style="list-style-type: none">• Warm water• Baking soda• Grease• Conventional wrench (for terminal clamp bolts)• Distilled water
Engine coolant level (→P. 306)	<ul style="list-style-type: none">• “TOYOTA Genuine 50/50 Pre-mixed Super Long Life Coolant BLUE” or similar high-quality ethylene glycol-based non-silicate, non-amine, non-nitrite and non-borate coolant with long-life hybrid organic acid technology. “TOYOTA Genuine 50/50 Pre-mixed Super Long Life Coolant BLUE” is pre-mixed with 50% coolant and 50% deionized water.• Funnel (used only for adding coolant)
Engine oil level (→P. 303)	<ul style="list-style-type: none">• “Toyota Genuine Motor Oil” or equivalent• Rag or paper towel, funnel (used only for adding engine oil)
Fuses (→P. 336)	<ul style="list-style-type: none">• Fuse with same amperage rating as original
Light bulbs (→P. 344)	<ul style="list-style-type: none">• Bulb with same number and wattage rating as original• Phillips-head screwdriver• Flathead screwdriver

Items	Parts and tools
Radiator and condenser (→P. 308)	—
Tire inflation pressure (→P. 324)	<ul style="list-style-type: none"> • Tire pressure gauge • Compressed air source
Washer fluid (→P. 313)	<ul style="list-style-type: none"> • Water washer fluid containing antifreeze (for winter use) • Funnel

 **CAUTION**

The engine compartment contains many mechanisms and fluids that may move suddenly, become hot, or become electrically energized. To avoid death or serious injury, observe the following precautions.

■ When working on the engine compartment

- Keep hands, clothing, and tools away from the moving fan and engine drive belt.
- Be careful not to touch the engine, radiator, exhaust manifold, etc. right after driving as they may be hot. Oil and other fluids may also be hot.
- Do not leave anything that may burn easily, such as paper or rags, in the engine compartment.
- Do not smoke, cause sparks or expose an open flame to fuel or the battery. Fuel and battery fumes are flammable.
- Be extremely cautious when working on the battery. It contains poisonous and corrosive sulfuric acid.
- Take care because brake fluid can harm your hands or eyes and damage painted surfaces.
If fluid gets on your hands or in your eyes, flush the affected area with clean water immediately.
If you still experience discomfort, see a doctor.

 **CAUTION****When working near the electric cooling fans or radiator grille**

Vehicles without a smart entry & start system: Be sure the engine switch is off. With the engine switch in the “ON” position, the electric cooling fans may automatically start to run if the air conditioning is on and/or the coolant temperature is high. (→P. 308)

Vehicles with a smart entry & start system: Be sure the “ENGINE START STOP” switch is off. With the “ENGINE START STOP” switch in IGNITION ON mode, the electric cooling fans may automatically start to run if the air conditioning is on and/or the coolant temperature is high. (→P. 308)

Safety glasses

Wear safety glasses to prevent flying or falling material, fluid spray, etc. from getting in the eyes.

 **NOTICE****If you remove the air cleaner filter**

Driving with the air cleaner filter removed may cause excessive engine wear due to dirt in the air.

If the fluid level is low or high

It is normal for the brake fluid level to go down slightly as the brake pads wear or when the fluid level in the accumulator is high.

If the reservoir needs frequent refilling, it may indicate a serious problem.

4-3. Do-it-yourself maintenance

Hood

Release the lock from the inside of the vehicle to open the hood.

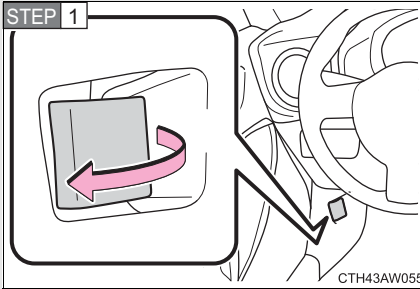

Pull the hood release lever.
The hood will pop up slightly.

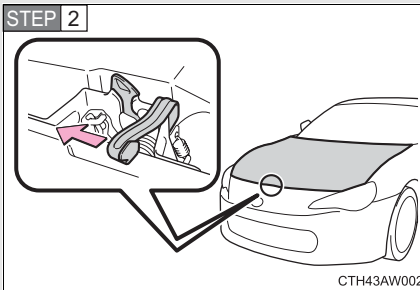

Push the auxiliary catch lever to the left and lift the hood.

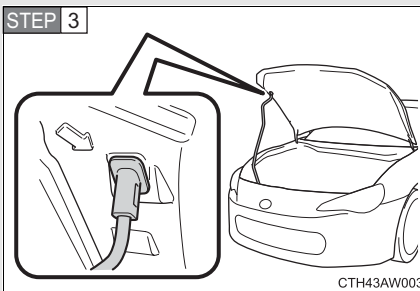

Hold the hood open by inserting the supporting rod into the slot.

 **CAUTION****■ Pre-driving check**

Check that the hood is fully closed and locked.

If the hood is not locked properly it may open while the vehicle is in motion and cause an accident, which may result in death or serious injury.

 **NOTICE****■ When opening the hood**

- Do not lift up or operate the wipers. Doing so may cause the hood and wipers to contact, scratching the hood.
- Use caution when opening the engine hood in windy weather as it may close suddenly in strong wind.
- Do not attach any accessories other than genuine Toyota products to the engine hood. Such additional weight on the engine hood may cause it to be too heavy to be supported by the supporting rod when opened.

■ When closing the hood

Do not apply excessive weight or force when closing the hood as doing so may result in damage.

4-3. Do-it-yourself maintenance

Positioning a floor jack

When raising your vehicle with a floor jack, position the jack correctly. Improper placement may damage your vehicle or cause injury.

■ Front

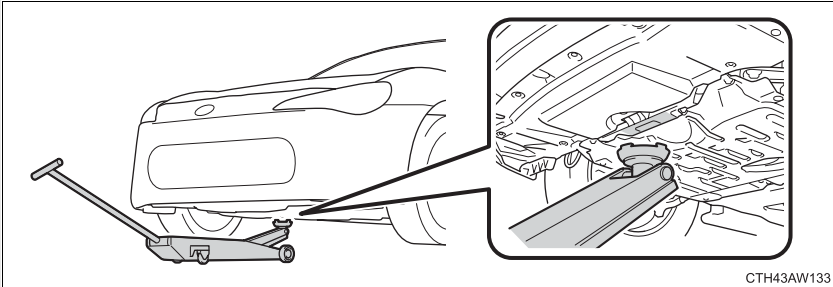

■ Rear

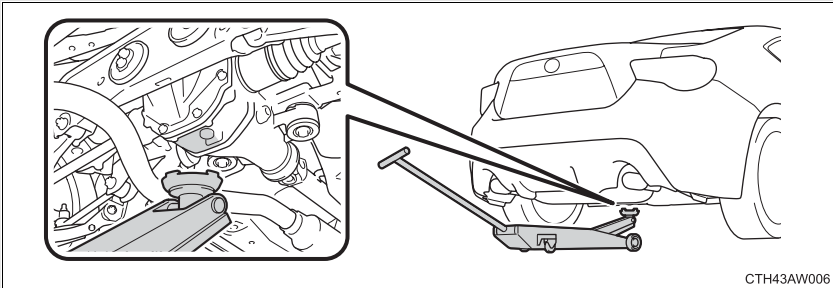

⚠ CAUTION

■ When raising your vehicle

Make sure to observe the following precautions to reduce the possibility of death or serious injury:

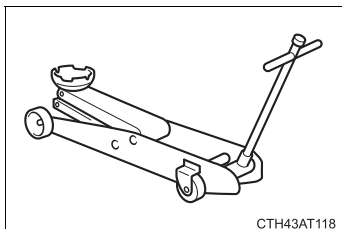

- Lift up the vehicle using a floor jack such as the one shown in the illustration.

- When using a floor jack, follow the instructions of the manual provided with the jack.
- Do not use the jack that was supplied with your vehicle.
- Do not put any part of your body underneath the vehicle when it is supported only by the floor jack.
- Always use floor jack and/or automotive jack stands on a solid, flat, level surface.
- Do not start the engine while the vehicle is supported by the floor jack.
- Stop the vehicle on level, firm ground, firmly set the parking brake and shift the shift lever to P (vehicles with an automatic transmission) or R (vehicles with a manual transmission).
- Make sure to set the floor jack properly at the jack point. Raising the vehicle with an improperly positioned floor jack will damage the vehicle and may cause the vehicle to fall off the floor jack.
- Do not raise the vehicle while someone is in the vehicle.
- When raising the vehicle, do not place any object on top of or underneath the floor jack.
- When raising the vehicle, ensure that there is sufficient surrounding space. The vehicle's position may change slightly when lowered.

4-3. Do-it-yourself maintenance

Engine compartment

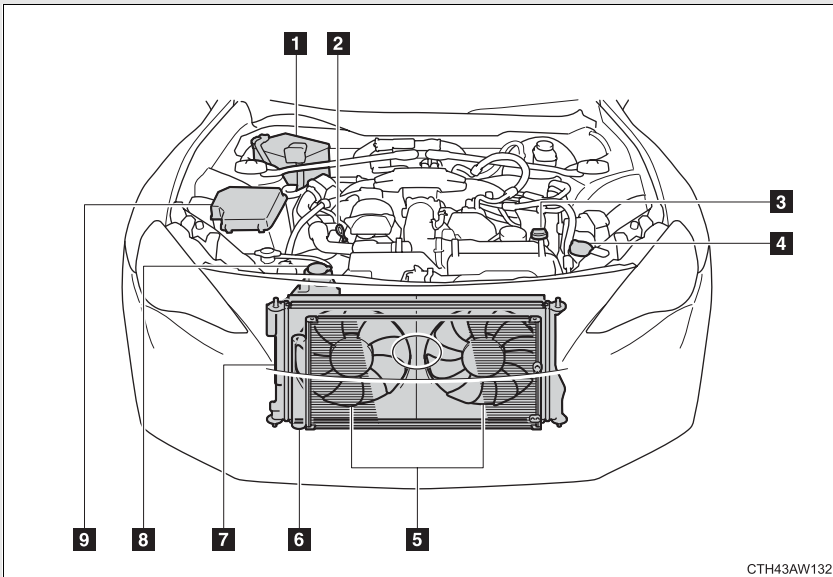

CTH43AW132

- | | | | |
|------------------------------------|-----------|-----------------------------------|-----------|
| 1 Battery* | (→P. 309) | 5 Electric cooling fans | |
| 2 Engine oil level dipstick | (→P. 303) | 6 Condenser (if equipped) | (→P. 308) |
| 3 Engine oil filler cap | (→P. 304) | 7 Radiator | (→P. 308) |
| 4 Washer fluid tank | (→P. 313) | 8 Engine coolant reservoir | (→P. 306) |
| | | 9 Fuse box | (→P. 336) |

*: For right-hand drive vehicles: This is located on the opposite side of the engine compartment.

Engine oil

With the engine at operating temperature and turned off, check the oil level on the dipstick.

■ Checking the engine oil

STEP 1 Park the vehicle on level ground. After warming up the engine and turning it off, wait more than five minutes for the oil to drain back into the bottom of the engine.

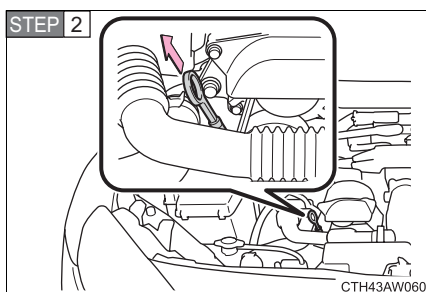

Hold a rag under the end and pull the dipstick out.

STEP 3 Wipe the dipstick clean.

STEP 4 Reinsert the dipstick fully.

STEP 5 Holding a rag under the end, pull the dipstick out and check the oil level.

When checking the oil, look at both sides of the dipstick and use the lower measurement to determine the level of oil.

STEP 6 Wipe the dipstick and reinsert it fully.

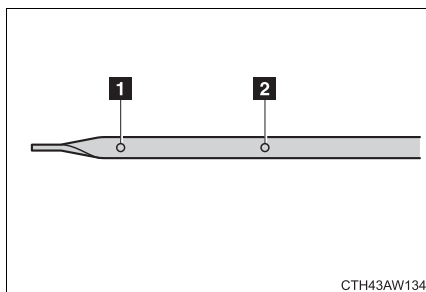

1 Low

2 Full

■ Adding engine oil

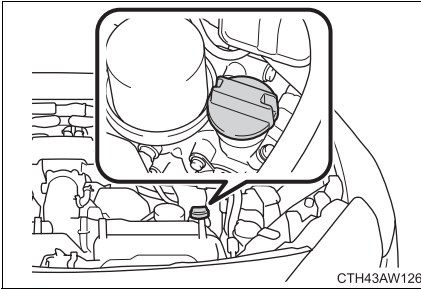

If the oil level is below or near the low level mark, add engine oil of the same type as already in the engine.

Make sure to check the oil type and prepare the items needed before adding oil.

Engine oil selection	→P. 438
Oil quantity (Low → Full)	1.0 L (1.1 qt., 0.9 Imp. qt.)
Items	Clean funnel

STEP 1 Remove the oil filler cap by turning it counterclockwise.

STEP 2 Add engine oil slowly, checking the dipstick.

STEP 3 Install the oil filler cap by turning it clockwise.

■ Engine oil consumption

A certain amount of engine oil will be consumed while driving. In the following situations, oil consumption may increase, and engine oil may need to be refilled in between oil maintenance intervals.

- When the engine is new, for example directly after purchasing the vehicle or after replacing the engine
- If low quality oil or oil of an inappropriate viscosity is used
- When driving at high engine speeds or with a heavy load, or when driving while accelerating or decelerating frequently
- When leaving the engine idling for a long time, or when driving frequently through heavy traffic

CAUTION

■ Used engine oil

- Used engine oil contains potentially harmful contaminants which may cause skin disorders such as inflammation or skin cancer, so care should be taken to avoid prolonged and repeated contact. To remove used engine oil from your skin, wash thoroughly with soap and water.
- Dispose of used oil and filters only in a safe and acceptable manner. Do not dispose of used oil and filters in household trash, in sewers or onto the ground.
Call any authorized Toyota dealer or repairer, or another duly qualified and equipped professional, service station or auto parts store for information concerning recycling or disposal.
- Do not leave used engine oil within the reach of children.

 NOTICE

■ **To prevent serious engine damage**

Check the oil level on a regular basis.

■ **When replacing the engine oil**

- Be careful not to spill engine oil on the vehicle components.
- Avoid overfilling, or the engine could be damaged.
- Check the oil level on the dipstick every time you refill the vehicle.
- Be sure the engine oil filler cap is properly tightened.

Engine coolant

The coolant level is satisfactory if it is between the “FULL” and “LOW” lines on the reservoir when the engine is cold.

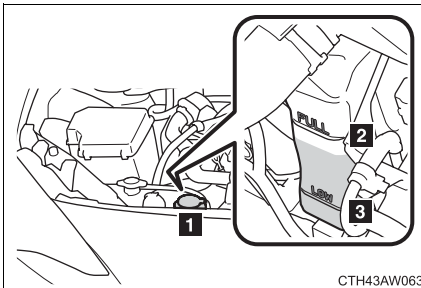

1 Reservoir cap

2 “FULL”

3 “LOW”

If the level is on or below the “LOW” line, add coolant up to the “FULL” line.

■ **If the coolant level drops within a short time after replenishing**

Visually check the radiator, hoses, engine coolant filler cap, radiator cap, drain cock and water pump.

If you cannot find a leak, have any authorized Toyota dealer or repairer, or another duly qualified and equipped professional pressure test the cap and check for leaks in the cooling system.

■ Coolant selection

Only use “TOYOTA Genuine 50/50 Pre-mixed Super Long Life Coolant BLUE” or similar high-quality ethylene glycol-based non-silicate, non-amine, non-nitrite, and non-borate coolant with long-life hybrid organic acid technology.

“TOYOTA Genuine 50/50 Pre-mixed Super Long Life Coolant BLUE” is a mixture of 50% coolant and 50% deionized water. (Enabled: -35°C [-31°F])

For more details about engine coolant, contact any authorized Toyota dealer or repairer, or another duly qualified and equipped professional.

CAUTION

■ When the engine is hot

Do not remove the radiator cap.

The cooling system may be under pressure and may spray hot coolant if the cap is removed, causing serious injuries, such as burns.

NOTICE

■ When adding engine coolant

Coolant is neither plain water nor straight antifreeze. The correct mixture of water and antifreeze must be used to provide proper lubrication, corrosion protection and cooling. Be sure to read the antifreeze or coolant label.

■ If you spill coolant

Be sure to wash it off with water to prevent it from damaging parts or paint.

Radiator and condenser

Check the radiator and condenser and clear any foreign objects.

If either of the above parts are extremely dirty or you are not sure of their condition, have your vehicle checked by any authorized Toyota dealer or repairer, or another duly qualified and equipped professional.

CAUTION

When the engine is hot







Do not touch the radiator or condenser as they may be hot and cause serious injuries, such as burns.

Battery

Check the battery as follows.

■ Caution symbols

The meanings of each caution symbol on the top of the battery are as follows:

	No smoking, no naked flames, no sparks		Battery acid
	Shield eyes		Note operating instructions
	Keep away from children		Explosive gas

■ Battery exterior

Make sure that the battery terminals are not corroded and that there are no loose connections, cracks, or loose clamps.

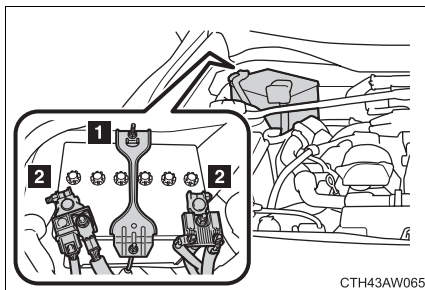

1 Hold-down clamp

2 Terminals

CTH43AW065

■ Checking battery fluid

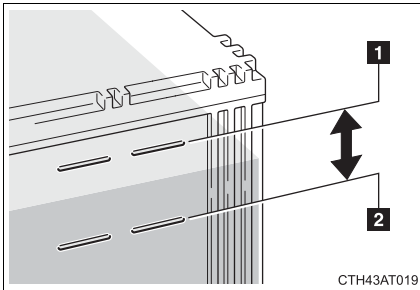

Check that the level is between “UPPER LEVEL” and “LOWER LEVEL”.

1 “UPPER LEVEL”

2 “LOWER LEVEL”

If the fluid level is at or below “LOWER LEVEL”, add distilled water.

■ Adding distilled water

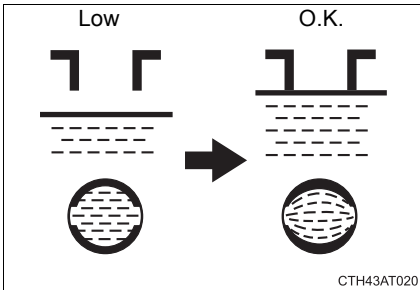

STEP 1 Remove the vent plug.

STEP 2 Add distilled water.

If the “UPPER LEVEL” line cannot be seen, check the fluid level by looking directly at the cell.

STEP 3 Put the vent plug back on and close securely.

■ Before recharging

When recharging, the battery produces hydrogen gas which is flammable and explosive. Therefore, before recharging:

- If recharging with the battery installed on the vehicle, be sure to disconnect the ground cable.
- Make sure the power switch on the charger is off when connecting and disconnecting the charger cables to the battery.

■ After recharging/reconnecting the battery (vehicles with a smart entry & start system)

- Unlocking the doors using the smart entry & start system may not be possible immediately after reconnecting the battery. If this happens, use the wireless remote control or the mechanical key to lock/unlock the doors.
- Start the engine with the “ENGINE START STOP” switch in ACCESSORY mode. The engine may not start with the “ENGINE START STOP” switch turned off. However, the engine will operate normally from the second attempt.
- The “ENGINE START STOP” switch mode is recorded by the vehicle. If the battery is reconnected, the vehicle will return the “ENGINE START STOP” switch mode to the status it was in before the battery was disconnected. Make sure to turn off the engine before disconnect the battery. Take extra care when connecting the battery if the “ENGINE START STOP” switch mode prior to discharge is unknown.

If the engine will not start even after multiple attempts, contact any authorized Toyota dealer or repairer, or another duly qualified and equipped professional.

 **CAUTION****■ Chemicals in the battery**

A battery contains poisonous and corrosive sulfuric acid and may produce hydrogen gas which is flammable and explosive. To reduce the risk of death or serious injury, take the following precautions while working on or near the battery:

- Do not cause sparks by touching the battery terminals with tools.
- Do not smoke or light a match near the battery.
- Avoid contact with eyes, skin and clothes.
- Never inhale or swallow electrolyte.
- Wear protective safety glasses when working near the battery.
- Keep children away from the battery.

■ Where to safely charge the battery

Always charge the battery in an open area. Do not charge the battery in a garage or closed room where there is not sufficient ventilation.

■ Emergency measures regarding electrolyte

- If electrolyte gets in your eyes
Flush your eyes with clean water for at least 15 minutes and get immediate medical attention. If possible, continue to apply water with a sponge or cloth while traveling to the nearest medical facility.
- If electrolyte gets on your skin
Wash the affected area thoroughly. If you feel pain or burning, get medical attention immediately.
- If electrolyte gets on your clothes
It can soak through clothing on to your skin. Immediately take off the clothing and follow the procedure above if necessary.
- If you accidentally swallow electrolyte
Drink a large quantity of water or milk. Get emergency medical attention immediately.

 NOTICE

■ **When recharging the battery**

Never recharge the battery while the engine is running. Also, be sure all accessories are turned off.

■ **When adding distilled water**

Avoid overfilling. Water spilled during battery recharging may cause corrosion.

Washer fluid

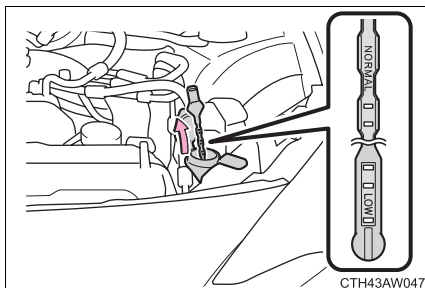

If the washer fluid level is at “LOW”, add washer fluid.

■ **Using the gauge**

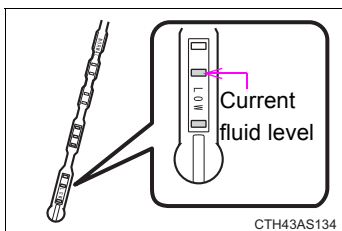

The washer fluid level can be checked by observing the position of the level on the liquid-covered holes in the gauge.

If the level falls below the second hole from the bottom (the “LOW” position), refill the washer fluid.

 **CAUTION**

■ **When adding washer fluid**

Do not add washer fluid when the engine is hot or running, as washer fluid contains alcohol and may catch fire if spilled on the engine etc.

 **NOTICE**

■ **Washer fluid**

Do not use soapy water or engine antifreeze instead of washer fluid. Doing so may cause streaking on the vehicle's painted surfaces.

■ **Diluting washer fluid**

Dilute washer fluid with water as necessary.
Refer to the freezing temperatures listed on the label of the washer fluid bottle.

Tires

Replace or rotate tires in accordance with maintenance schedules and treadwear.

■ Checking tires

Check if the treadwear indicators are showing on the tires. Also check the tires for uneven wear, such as excessive wear on one side of the tread.

Check the spare tire condition and pressure if not rotated.

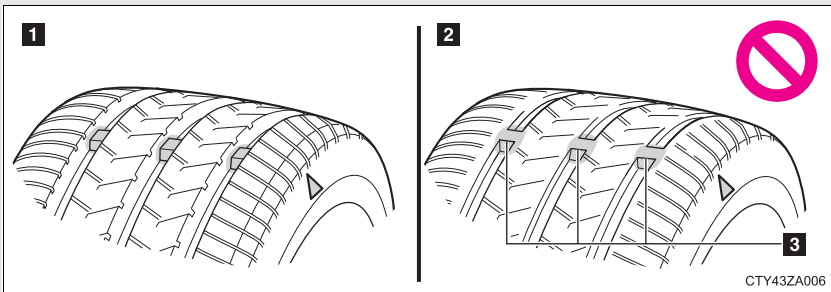

1 New tread

2 Worn tread

3 Treadwear indicator

The location of treadwear indicators is shown by a “TWI” or “Δ” mark, etc., molded into the sidewall of each tire.

Replace the tires if the treadwear indicators are showing on a tire.

■ Tire rotation

Vehicles with an emergency tire puncture repair kit

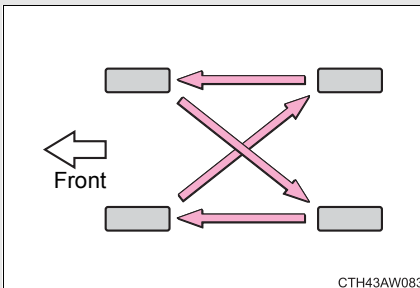

Rotate the tires in the order shown.

To equalize tire wear and help extend tire life, Toyota recommends that tire rotation is carried out approximately every 10000 km (6000 miles).

Vehicles with a spare tire of the same wheel type as the installed tires

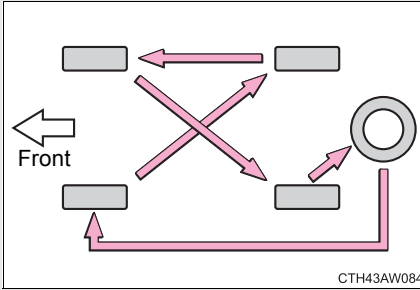

Rotate the tires in the order shown.

To equalize tire wear and help extend tire life, Toyota recommends that tire rotation is carried out approximately every 10000 km (6000 miles).

■ Tire pressure warning system

Your Toyota is equipped with a tire pressure warning system that uses tire pressure warning valves and transmitters to detect low tire inflation pressure before serious problems arise.

(→P. 377)

Installing tire pressure warning valves and transmitters

When replacing tires or wheels, tire pressure warning valves and transmitters must also be installed.

When new tire pressure warning valves and transmitters are installed, new tire pressure warning valve and transmitter ID codes must be registered in the tire pressure warning computer and tire pressure warning system must be initialized. Have tire pressure warning valve and transmitter ID codes registered by any authorized Toyota dealer or repairer, or another duly qualified and equipped professional. (→P. 318)

■ How to initialize the tire pressure warning system

STEP 1 Park the vehicle in a safe place and turn the “ENGINE START STOP” switch (vehicles with a smart entry & start system) or the engine switch (vehicles without a smart entry & start system) off.

Initialization cannot be performed while the vehicle is moving.

STEP 2 Adjust the tire inflation pressure to the specified cold tire inflation pressure level. (→P. 445)

Make sure to adjust the tire pressure to the specified cold tire inflation pressure level. The tire pressure warning system will operate based on this pressure level.

STEP 3 Turn the “ENGINE START STOP” switch to IGNITION ON mode (vehicles with a smart entry & start system) or engine switch to the “ON” position (vehicles without a smart entry & start system).

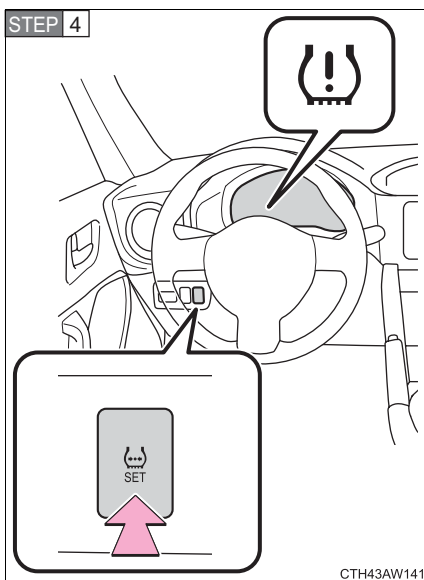

Press and hold the tire pressure warning reset switch until the tire pressure warning light blinks slowly 3 times.

STEP 5 Vehicles with a smart entry & start system: Wait for a few minutes with the “ENGINE START STOP” switch in IGNITION ON mode and then turn the “ENGINE START STOP” switch off.
Vehicles without a smart entry & start system: Wait for a few minutes with the engine switch in the “ON” position and then turn the engine switch to the “ACC” or “LOCK” position.

Registering ID codes

The tire pressure warning valve and transmitter is equipped with a unique ID code. When replacing a tire pressure warning valve and transmitter, it is necessary to register the ID code. Have the ID code registered by any authorized Toyota dealer or repairer, or another duly qualified and equipped professional.

■ When to replace your vehicle's tires

Tires should be replaced if:

- The treadwear indicators are showing on a tire.
- You have tire damage such as cuts, splits, cracks deep enough to expose the fabric or bulges indicating internal damage
- A tire goes flat repeatedly or cannot be properly repaired due to the size or location of a cut or other damage

If you are not sure, consult with any authorized Toyota dealer or repairer, or another duly qualified and equipped professional.

■ Replacing tires and wheels

If the ID code of the tire pressure warning valve and transmitter is not registered, the tire pressure warning system will not work properly. After driving for about 10 minutes, the tire pressure warning light comes on after blinking for 1 minute to indicate a system malfunction.

■ Tire life

Any tires over 6 years old must be checked by a qualified technician even if they have seldom or never been used or damage is not obvious.

■ Routine tire inflation pressure checks

The tire pressure warning system does not replace routine tire inflation pressure checks. Make sure to check tire inflation pressure as part of your routine of daily vehicle checks.

■ If the tread on snow tires wears down 4 mm (0.16 in.)

The effectiveness of snow tires is lost.

■ Low profile tires (vehicles with 17-inch tires)

Generally, low profile tires will wear more rapidly and tire grip performance will be reduced on snowy and/or icy roads when compared to standard tires. Be sure to use snow tires or tire chains on snowy and/or icy roads and drive carefully at a speed appropriate for road and weather conditions.

■ If you press the tire pressure warning reset switch accidentally

If initialization is performed, adjust the tire inflation pressure to the specified level and initialize the tire pressure warning system again.

■ Tire pressure warning system certification



The latest "DECLARATION of CONFORMITY" (DoC) is available at the following address:
<http://www.globaldenso.com/en/products/oem/index.html>

Hereby, DENSO CORPORATION declares that this 23AAF is in compliance with the essential requirements and other relevant provisions of Directive 1999/5/EC.

DENSO CORPORATION vakuuttaa täten että 23AAF tyyppinen laite on direktiivin 1999/5/EY oleellisten vaatimusten ja sitä koskevien direktiivin muiden ehtojen mukainen.

Hierbij verklaart DENSO CORPORATION dat het toestel 23AAF in overeenstemming is met de essentiële eisen en de andere relevante bepalingen van richtlijn 1999/5/EG.

Par la présente DENSO CORPORATION déclare que l'appareil 23AAF est conforme aux exigences essentielles et aux autres dispositions pertinentes de la directive 1999/5/CE.

Härmed intygar DENSO CORPORATION att denna 23AAF står i överensstämmelse med de väsentliga egenskapskrav och övriga relevanta bestämmelser som framgår av direktiv 1999/5/EG.

Undertegnede DENSO CORPORATION erklærer herved, at følgende udstyr 23AAF overholder de væsentlige krav og øvrige relevante krav i direktiv 1999/5/EF.

Hiermit erkläre DENSO CORPORATION, dass sich das Gerät 23AAF in Übereinstimmung mit den grundlegenden Anforderungen und den übrigen einschlägigen Bestimmungen der Richtlinie 1999/5/EG befindet.

ΜΕ ΤΗΝ ΠΑΡΟΥΣΑ DENSO CORPORATION ΔΗΛΩΝΕΙ ΟΤΙ 23AAF ΣΥΜΜΟΡΦΩΝΕΤΑΙ ΠΡΟΣ ΤΙΣ ΟΥΣΙΩΔΕΙΣ ΑΠΑΙΤΗΣΕΙΣ ΚΑΙ ΤΙΣ ΛΟΙΠΕΣ ΣΧΕΤΙΚΕΣ ΔΙΑΤΑΞΕΙΣ ΤΗΣ ΟΔΗΓΙΑΣ 1999/5/ΕΚ.

Con la presente DENSO CORPORATION dichiara che questo 23AAF è conforme ai requisiti essenziali ed alle altre disposizioni pertinenti stabilite dalla direttiva 1999/5/CE.

Por medio de la presente DENSO CORPORATION declara que el 23AAF cumple con los requisitos esenciales y cualesquiera otras disposiciones aplicables o exigibles de la Directiva 1999/5/CE.

DENSO CORPORATION declara que este 23AAF está conforme com os requisitos essenciais e outras disposições da Directiva 1999/5/CE.

Hawnhekk, DENSO CORPORATION, jiddikjara li dan 23AAF jikkonforma mal-hittigijiet essenzjali u ma provvedimenti oħrajn relevanti li hemm fid-Direttiva 1999/5/EC.

Käesolevaga kinnitab DENSO CORPORATION seadme 23AAF vastavust direktiivi 1999/5/EÜ põhinõuetele ja nimetatud direktiivist tulenevatele teistele asjakohastele sätetele.

Alulirõtt, DENSO CORPORATION nyilatkozm, hogy a 23AAF megfelel a vonatkozó alapvető követelményeknek és az 1999/5/EC irányelv egyéb előírásainak.

DENSO CORPORATION týmto vyhlasuje, že 23AAF splňa základné požiadavky a všetky príslušné ustanovenia Smernice 1999/5/ES.

DENSO CORPORATION tímto prohlašuje, že tento 23AAF je ve shodě se základními požadavky a dalšími příslušnými ustanoveními směrnice 1999/5/ES.

DENSO CORPORATION izjavlja, da je ta 23AAF v skladu z bistvenimi zahtevami in ostalimi relevantnimi določili direktive 1999/5/ES.

Šiuo DENSO CORPORATION deklaruoja, kad šis 23AAF atitinka esminius reikalavimus ir kitas 1999/5/EB Direktyvos nuostatas.

Ar šo DENSO CORPORATION deklarē, ka 23AAF atbilst Direktīvas 1999/5/EK būtiskajām prasībām un citiem ar to saistītajiem noteikumiem.

Niniejszym DENSO CORPORATION oświadcza, że 23AAF jest zgodny z zasadniczymi wymogami oraz pozostałymi stosownymi postanowieniami Dyrektywy 1999/5/EC.

Hér með lýsir DENSO CORPORATION yfir því að 23AAF er í samræmi við grunnkröfur og aðrar kröfur, sem gerðar eru í tilskipun 1999/5/EC.

DENSO CORPORATION erklærer herved at utstyret 23AAF er i samsvar med de grunnleggende krav og øvrige relevante krav i direktiv 1999/5/EF.

С настоящето, DENSO CORPORATION, декларира, че 23AAF е в съответствие със съществените изисквания и другите приложими разпоредби на Директива 1999/5/EC.

Prin prezenta, DENSO CORPORATION, declară că aparatul 23AAF este în conformitate cu cerințele esențiale și cu alte prevederi pertinente ale Directivei 1999/5/CE.

Ovim, DENSO CORPORATION, izjavljuje da ovaj 23AAF je usklađen sa bitnim zahtjevima i drugim relevantnim odredbama Direktive 1999/5/EC.

Ovim, DENSO CORPORATION, deklarirše da je 23AAF u skladu sa osnovnim zahtevima i ostalim relevantnim odredbama Direktive 1999/5/EC.

Ovim DENSO CORPORATION, izjavljuje da je 23AAF u sklau s bitnim zahtjevima i drugim relevantnim odredbama Direktive 1999/5/EC i Pravilnika o RiTT opremi (NN 25/2012).

The latest "DECLARATION OF CONFORMITY "(DoC) is available at the following:
DoC address : <http://www.pacific-ind.co.jp/eng/products/car/tpms/doc/>

CE 0891

Hereby, PACIFIC INDUSTRIAL CO.,LTD., declares that this PMV-C210 is in compliance with the essential requirements and other relevant provisions of Directive 1999/5/EC.

PACIFIC INDUSTRIAL CO.,LTD. vakuuttaa täten että PMV-C210 tyyppinen laite on direktiivin 1999/5/EY oleellisten vaatimusten ja sitä koskevien direktiivin muiden ehtojen mukainen.

Hierbij verklaart PACIFIC INDUSTRIAL CO.,LTD. dat het toestel PMV-C210 in overeenstemming is met de essentiële eisen en de andere relevante bepalingen van richtlijn 1999/5/EG.

Par la présente PACIFIC INDUSTRIAL CO.,LTD. déclare que l'appareil PMV-C210 est conforme aux exigences essentielles et aux autres dispositions pertinentes de la directive 1999/5/CE.

Härmed intygar PACIFIC INDUSTRIAL CO.,LTD. att denna PMV-C210 står i överensstämmelse med de väsentliga egenskapskrav och övriga relevanta bestämmelser som framgår av direktiv 1999/5/EG.

Undertegnede PACIFIC INDUSTRIAL CO.,LTD. erklærer herved, at følgende udstyr PMV-C210 overholder de væsentlige krav og øvrige relevante krav i direktiv 1999/5/EF.

Hiermit erklärt PACIFIC INDUSTRIAL CO.,LTD., dass sich das Gerät PMV-C210 in Übereinstimmung mit den grundlegenden Anforderungen und den übrigen einschlägigen Bestimmungen der Richtlinie 1999/5/EG befindet.

Μ Ε Τ Η Ν Π Α Ρ Ο Υ Σ Α PACIFIC INDUSTRIAL CO.,LTD. Δ Η Λ Ω Ν Ε Ι Ο Τ Ι PMV-C210 Σ Υ Μ Μ Ο Ρ Φ Ω Ν Ε Τ Α Ι Π Ρ Ο Σ Τ Ι Σ Ο Υ Σ Ι Ω Δ Ε Ι Σ Α Π Α Ι Τ Η Σ Ε Ι Σ Κ Α Ι Τ Ι Σ Λ Ο Ι Π Ε Σ Σ Χ Ε Τ Ι Κ Ε Σ Δ Ι Α Τ Α Ξ Ε Ι Σ Τ Η Σ Ο Δ Η Γ Ι Α Σ 1999/5/ΕΚ.

Con la presente PACIFIC INDUSTRIAL CO.,LTD. dichiara che questo PMV-C210 è conforme ai requisiti essenziali ed alle altre disposizioni pertinenti stabilite dalla direttiva 1999/5/CE.

Por medio de la presente PACIFIC INDUSTRIAL CO.,LTD. declara que el PMV-C210 cumple con los requisitos esenciales y cualesquiera otras disposiciones aplicables o exigibles de la Directiva 1999/5/CE.

PACIFIC INDUSTRIAL CO.,LTD. declara que este PMV-C210 está conforme com os requisitos essenciais e outras disposições da Directiva 1999/5/CE.

Hawnhekk, PACIFIC INDUSTRIAL CO.,LTD., jiddikjara li dan PMV-C210 jikkonforma mal-htigijiet essenzjali u ma provvedimenti o trajaq relevanti li hemm fid-Direttiva 1999/5/EC.

Käesolevaga kinnitab PACIFIC INDUSTRIAL CO.,LTD. seadme PMV-C210 vastavust direktiivi 1999/5/EÜ põhinõuetele ja nimetatud direktiivist tulenevatele teistele asjakohastele sätetele.

Alulírótt, PACIFIC INDUSTRIAL CO.,LTD. nyilatkozom, hogy a PMV-C210 megfelel a vonatkozó alapvető követelményeknek és az 1999/5/EC irányelv egyéb előírásainak.

PACIFIC INDUSTRIAL CO.,LTD. týmto vyhlasuje, že PMV-C210 spĺňa základné požiadavky a všetky príslušné ustanovenia Smernice 1999/5/ES.

PACIFIC INDUSTRIAL CO.,LTD. tímto prohlašuje, že tento PMV-C210 je ve shodě se základními požadavky a dalšími příslušnými ustanoveními směrnice 1999/5/ES.

PACIFIC INDUSTRIAL CO.,LTD. izjavlja, da je ta PMV-C210 v skladu z bistvenimi zahtevami in ostalimi relevantnimi določili direktive 1999/5/ES.

Šiuo PACIFIC INDUSTRIAL CO.,LTD. deklaruoja, kad šis PMV-C210 atitinka esminius reikalavimus ir kitas 1999/5/EB Direktyvos nuostatas.

Ar šo PACIFIC INDUSTRIAL CO.,LTD. deklarē, ka PMV-C210 atbilst Direktīvas 1999/5/EK būtiskajām prasībām un citiem ar to saistītajiem noteikumiem.

Niniejszym PACIFIC INDUSTRIAL CO.,LTD. oświadczam, że PMV-C210 jest zgodny z zasadniczymi wymogami oraz pozostałymi stosownymi postanowieniami Dyrektywy 1999/5/EC.

Hér með lýsir PACIFIC INDUSTRIAL CO.,LTD. yfir því að PMV-C210 er í samræmi við grunnkröfur og aðrar kröfur, sem gerðar eru í tilskipun 1999/5/EC.

PACIFIC INDUSTRIAL CO.,LTD. erklærer herved at utstyret PMV-C210 er i samsvar med de grunnleggende krav og øvrige relevante krav i direktiv 1999/5/EF.

С н а с т о я щ е т о, PACIFIC INDUSTRIAL CO.,LTD., д е к л а р и р а, ч е PMV-C210 е в с ъ о т в е т с т в и е с ъ с с ѣ щ е с т в е н и т е и з и с к в а н и я и д р у г и т е п р и л о ж и м и р а з п о р е д б и н а Д и р е к т и в а 1999/5/ЕС.

Prin prezenta, PACIFIC INDUSTRIAL CO.,LTD., declară că aparatul PMV-C210 este in conformitate cu cerintele esențiale și cu alte prevederi pertinente ale Directivei 1999/5/CE.

Ovim , PACIFIC INDUSTRIAL CO.,LTD., izjavjuje da ovaj PMV-C210 je usklađen sa bitnim zahtjevima i drugim relevantnim odredbama Direktive 1999/5/EC.

Ovim PACIFIC INDUSTRIAL CO.,LTD., izjavjuje da je PMV-C210 u skladu s bitnim zahtjevima i drugim relevantnim odredbama Direktive 1999/5/EC.

Me aně tē kēsaj, PACIFIC INDUSTRIAL CO., LTD., Deklaron se ky PMV-C210 eshtë në përputhje me kërkesat themelore dhe dispozitat e tjera përkatëse të direktivës 1999/5/EC.

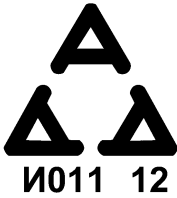

 CAUTION

■ Tire pressure warning system operation

The tire pressure warning system may not provide warning immediately if a tire bursts or if sudden air leakage occurs.

■ When inspecting or replacing tires

Observe the following precautions to prevent accidents.

Failure to do so may cause damage to parts of the drive train, as well as dangerous handling characteristics, which may lead to an accident resulting in death or serious injury.

- Make sure to install 4 tires that are of the specified size, and that all 4 tires are the same size, same maker, same brand and tread pattern.
- Do not use tire sizes other than those recommended by Toyota.
- Only use radial tires.
- Do not mix summer, all season and snow tires.
- Do not use tires that have been used on another vehicle.
Do not use tires if you do not know how they were used previously.

■ When initializing the tire pressure warning system

Do not operate the tire pressure warning reset switch without first adjusting the tire inflation pressure to the specified level. Otherwise, the tire pressure warning light may not come on even if the tire inflation pressure is low, or it may come on when the tire inflation pressure is actually normal.

 NOTICE

■ **Repairing or replacing tires, wheels, tire pressure warning valves, transmitters and tire valve caps**

- When removing or fitting the wheels, tires or the tire pressure warning valves and transmitters, contact any authorized Toyota dealer or repairer, or another duly qualified and equipped professional as the tire pressure warning valves and transmitters may be damaged if not handled correctly.
- Make sure to install the tire valve caps. If the tire valve caps are not installed, water could enter the tire pressure warning valves and the tire pressure warning valves could be bound.
- When replacing tire valve caps, do not use tire valve caps other than those specified. The cap may become stuck.

■ **To avoid damage to the tire pressure warning valves and transmitters**

When a tire is repaired with liquid sealants, the tire pressure warning valve and transmitter may not operate properly. If a liquid sealant is used, contact any authorized Toyota dealer or repairer, or another duly qualified and equipped professional or other qualified service shop as soon as possible. After use of liquid sealant, make sure to replace the tire pressure warning valve and transmitter when repairing or replacing the tire. (→P. 316)

■ **Driving on rough roads**

Take particular care when driving on roads with loose surfaces or pot holes. These conditions may cause losses in tire air pressure, reducing the cushioning ability of the tires. In addition driving on rough roads may cause damage to the tires themselves, as well as the vehicle's wheels and body.

■ **Low profile tires and wheels (vehicles with 17-inch tires)**

Low profile tires may cause greater damage than usual to the tire wheel when receiving impact from the road surface. Therefore pay attention to the following:

- Be sure to use proper tire inflation pressure. If tires are under-inflated, they may be damaged more severely.
- Avoid pot holes, uneven pavement, curbs and other road hazards. Failure to do so can lead to severe tire and wheel damage.

■ **If tire pressures become low while driving**

Do not continue driving, or your tires and/or wheels may be ruined.

4-3. Do-it-yourself maintenance

Tire inflation pressure

Make sure to maintain the proper tire inflation pressure. Tire inflation pressure should be checked at least once per month. However, Toyota recommends that tire inflation pressure be checked once every two weeks. (→P. 445)

■ Effects of incorrect tire inflation pressure

Driving with incorrect tire inflation pressure may result in the following:

- Reduced fuel economy
- Reduced driving comfort and poor handling
- Reduced tire life due to wear
- Reduced safety
- Damage to the drive train

If a tire needs frequent refilling, have it checked by any authorized Toyota dealer or repairer, or another duly qualified and equipped professional.

■ Instructions for checking tire pressure

When checking tire inflation pressure, observe the following:

- Check only when the tires are cold.
If your vehicle has been parked for at least 3 hours and has not been driven for more than 1.5 km or 1 mile, you will get an accurate cold tire inflation pressure reading.
- Always use a tire pressure gauge.
It is difficult to judge if a tire is properly inflated based only on its appearance.
- It is normal for the tire inflation pressure to be higher after driving as heat is generated in the tire. Do not reduce tire inflation pressure after driving.
- Passengers and luggage weight should be placed so that the vehicle is balanced.

 **CAUTION****■ Proper inflation is critical to save tire performance**

Keep your tires properly inflated.

If the tires are not properly inflated, the following conditions may occur which could lead to an accident resulting in death or serious injury:

- Excessive wear
- Uneven wear
- Poor handling
- Possibility of blowouts resulting from overheated tires
- Air leaking from between tire and wheel
- Wheel deformation and/or tire damage
- Greater possibility of tire damage while driving (due to road hazards, expansion joints, sharp edges in the road, etc.)

 **NOTICE****■ When inspecting and adjusting tire pressure**

Be sure to reinstall the tire valve caps.

If a valve cap is not installed, dirt or moisture may get into the valve and cause an air leak, resulting in decreased tire inflation pressure.

Wheels

If a wheel is bent, cracked or heavily corroded, it should be replaced. Otherwise, the tire may separate from the wheel or cause loss of handling control.

■ Wheel selection

When replacing wheels, care should be taken to ensure that they are equivalent to those removed in load capacity, diameter, rim width, and inset*.

Replacement wheels are available at any authorized Toyota dealer or repairer, or another duly qualified and equipped professional.

*: Conventionally referred to as “offset”.

Toyota does not recommend using:

- Wheels of different sizes or types
- Used wheels
- Bent wheels that have been straightened

■ Aluminum wheel precautions

- Use only Toyota wheel nuts and wrenches designed for use with your aluminum wheels.
- When rotating, repairing or changing your tires, check that the wheel nuts are still tight after driving 1600 km (1000 miles).
- Be careful not to damage the aluminum wheels when using tire chains.
- Use only Toyota genuine balance weights or equivalent and a plastic or rubber hammer when balancing your wheels.

■ When replacing wheels

The wheels of your Toyota are equipped with tire pressure warning valves and transmitters that allow the tire pressure warning system to provide advance warning in the event of a loss in tire inflation pressure. Whenever wheels are replaced, the tire pressure warning valves and transmitters must be installed. (→P. 316)

⚠ CAUTION

■ When replacing wheels

- Do not use wheels that are a different size from those recommended in the Owner's Manual, as this may result in loss of handling control.
- Never use an inner tube in a leaking wheel which is designed for a tubeless tire. Doing so may result in an accident, causing death or serious injury.

■ When installing the wheel nuts

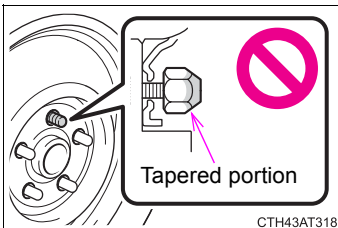

- Be sure to install the wheel nuts with the tapered ends facing inward. Installing the nuts with the tapered ends facing outward can cause the wheel to break and eventually cause the wheel to come off while driving, which could lead to an accident resulting in death or serious injury.

- Never use oil or grease on the wheel bolts or wheel nuts. Oil and grease may cause the wheel nuts to be excessively tightened, leading to bolt or disc wheel damage. In addition, the oil or grease can cause the wheel nuts to loosen and the wheel may fall off, causing an accident and resulting in death or serious injury. Remove any oil or grease from the wheel bolts or wheel nuts.



NOTICE

■ Replacing tire pressure warning valves and transmitters

- Because tire repair or replacement may affect the tire pressure warning valves and transmitters, make sure to have tires serviced by any authorized Toyota dealer or repairer, or another duly qualified and equipped professional or other qualified service shop. In addition, make sure to purchase your tire pressure warning valves and transmitters at any authorized Toyota dealer or repairer, or another duly qualified and equipped professional.
- Ensure that only genuine Toyota wheels are used on your vehicle. Tire pressure warning valves and transmitters may not work properly with non-genuine wheels.

4-3. Do-it-yourself maintenance

Air conditioning filter

The air conditioning filter must be changed regularly to maintain air conditioning efficiency.

■ Removal method

STEP 1 Vehicles without a smart entry & start system

Turn the engine switch off.

Vehicles with a smart entry & start system

Turn the “ENGINE START STOP” switch off.

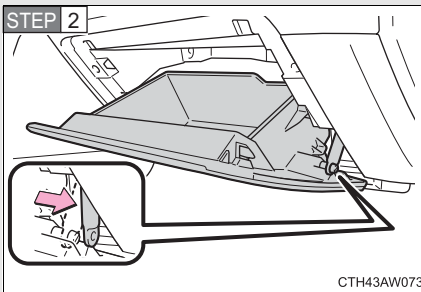

Open the glove box. Slide off the damper.

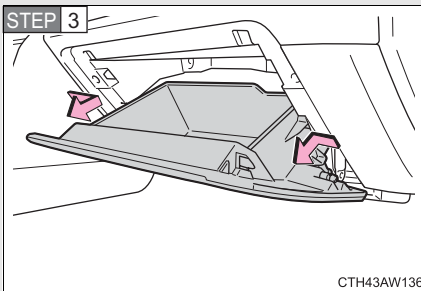

Push in each side of the glove box and pull the glove box toward you to disconnect the claws.

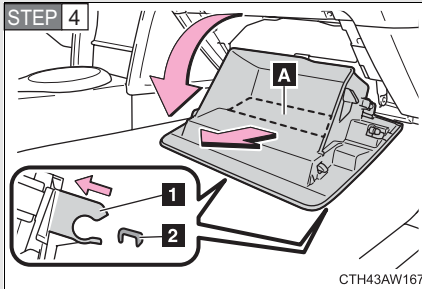

Lower the glove box slowly until surface **A** is horizontal with the floor, then pull it out. (Simply pulling with gentle force will disengage the lower claws.)

- 1** Lower claw
- 2** Lower claw engagement point

Do not forcibly pull the glove box. Otherwise, the lower claws or the lower claw engagement points may be deformed, making it difficult to reinstall or close the glove box.

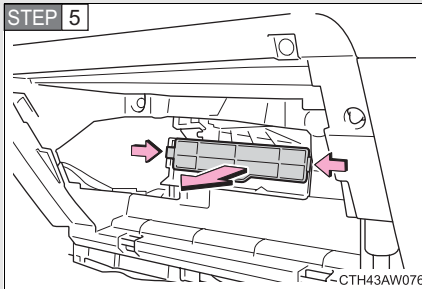

Remove the filter cover.

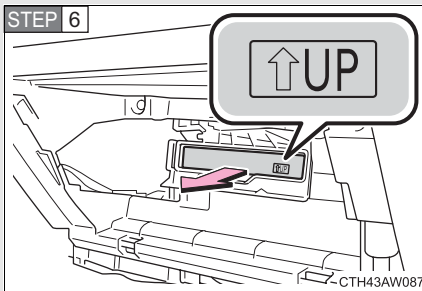

Remove the air conditioning filter and replace it with a new one.

The “↑UP” marks shown on the filter should be pointing up.

■ Checking interval

Inspect and replace the air conditioning filter according to the maintenance schedule. In dusty areas or areas with heavy traffic flow, early replacement may be required. (For scheduled maintenance information, please refer to the “Toyota Service Booklet” or “Toyota Warranty Booklet”.)

■ If air flow from the vents decreases dramatically

The filter may be clogged. Check the filter and replace if necessary.

**NOTICE****■ When removing the glove box**

Do not forcibly pull the glove box. Otherwise, the lower claws or the lower claw engagement points may be deformed, making it difficult to reinstall or close the glove box.

■ When using the air conditioning system

Make sure that a filter is always installed.

Using the air conditioning system without a filter may cause damage to the system.

4-3. Do-it-yourself maintenance

Wireless remote control/electronic key battery

Replace the battery with a new one if it is depleted.

■ You will need the following items:

- Flathead screwdriver
- Lithium battery CR2016 (vehicles without a smart entry & start system), or CR1632 (vehicles with a smart entry & start system)

■ Replacing the battery (vehicles without a smart entry & start system)

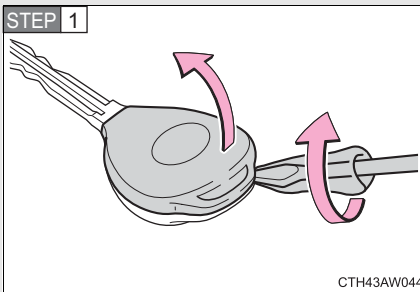

Remove the cover.

To prevent damage to the key, cover the tip of the screwdriver with a rag.

To prevent the buttons from being disassembled, face the button surface downward.

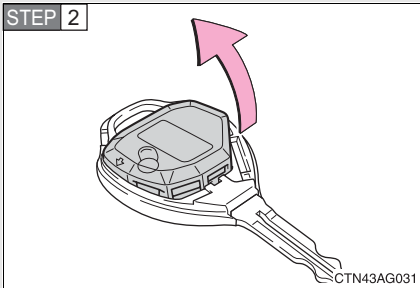

Remove the module.

STEP 3

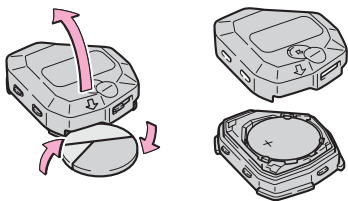

CTN43AG032

Open the case cover using a coin protected with tape etc. and remove the depleted battery.

Insert a new battery with the “+” terminal facing up.

■ Replacing the battery (vehicles with a smart entry & start system)

STEP 1

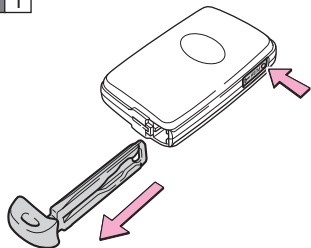

CTH11AW005

Take out the mechanical key.

STEP 2

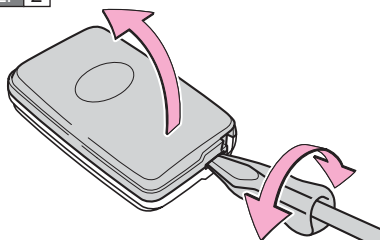

CTH43AT157

Remove the cover.

To prevent damage to the key, cover the tip of the screwdriver with a rag.

STEP 3

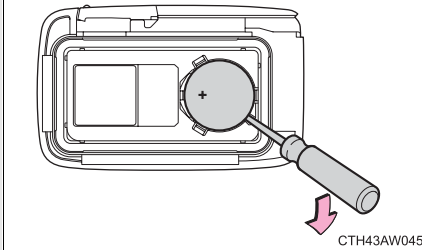

Remove the depleted battery.

Insert a new battery with the “+” terminal facing up.

■ **Use a CR2016 (vehicles without a smart entry & start system) or CR1632 (vehicles with a smart entry & start system) lithium battery**

- Batteries can be purchased at any authorized Toyota dealer or repairer, or another duly qualified and equipped professional, local electrical appliance shops or camera stores.
- Replace only with the same or equivalent type recommended by the manufacturer.
- Dispose of used batteries according to local laws.

■ **If the key battery is depleted**

The following symptoms may occur:

- The smart entry & start system (if equipped) and wireless remote control will not function properly.
- The operational range will be reduced.

■ **When putting the module back (vehicles without a smart entry & start system)**

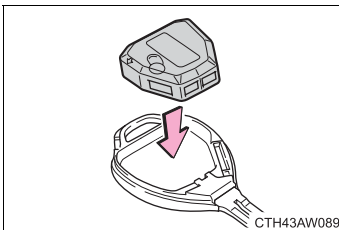

Insert the module from directly above. Inserting it on an angle may prevent the key buttons from operating properly.

 CAUTION**■ Removed battery and other parts**

These parts are small and if swallowed by a child, they can cause choking. Keep away from children. Failure to do so could result in death or serious injury.

■ Certification for the lithium battery

- RISK OF EXPLOSION IF BATTERY IS REPLACED BY AN INCORRECT TYPE. DISPOSE OF USED BATTERIES ACCORDING TO THE INSTRUCTIONS
- Batteries shall not be exposed to excessive heat such as sunshine, fire or the like.

 NOTICE**■ For normal operation after replacing the battery**

Observe the following precautions to prevent accidents:

- Always work with dry hands.
Moisture may cause the battery to rust.
- Do not touch or move any other component inside the remote control.
- Do not bend either of the battery terminals.

4-3. Do-it-yourself maintenance

Checking and replacing fuses

If any of the electrical components do not operate, a fuse may have blown. If this happens, check and replace the fuses as necessary.

STEP 1 Vehicles without a smart entry & start system

Turn the engine switch off.

Vehicles with a smart entry & start system

Turn the “ENGINE START STOP” switch off.

STEP 2 Open the fuse box cover.

Engine compartment

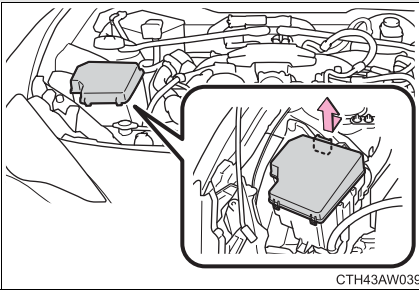

Push the tabs in and lift the lid off.

Instrument panel

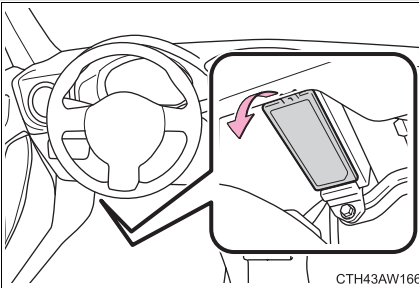

Remove the lid.

STEP 3 After a system failure, see “Fuse layout and amperage ratings” (→P. 339) for details about which fuse to check.

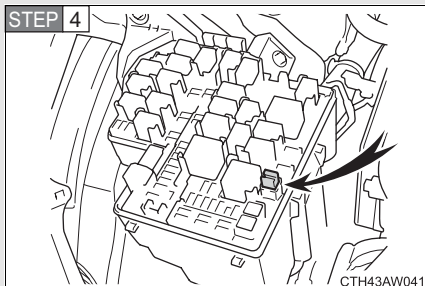

Remove the fuse with the pull-out tool.

STEP 5 Check if the fuse has blown.

Type A

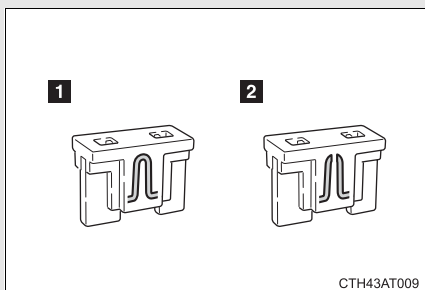

1 Normal fuse

2 Blown fuse

Replace it with one of an appropriate amperage rating. The amperage rating can be found on the fuse box lid.

Type B

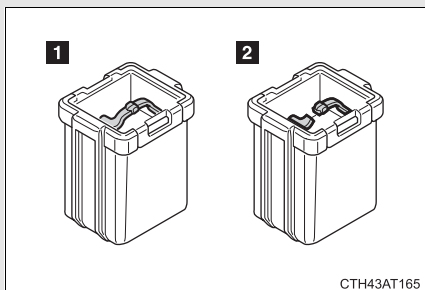

1 Normal fuse

2 Blown fuse

Replace it with one of an appropriate amperage rating. The amperage rating can be found on the fuse box lid.

Type C

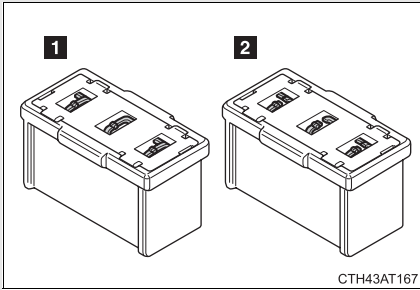

1 Normal fuse

2 Blown fuse

Contact any authorized Toyota dealer or repairer, or another duly qualified and equipped professional.

Type D

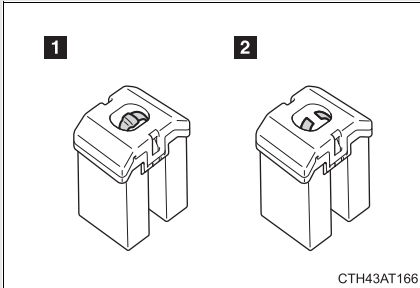

1 Normal fuse

2 Blown fuse

Contact any authorized Toyota dealer or repairer, or another duly qualified and equipped professional.

Fuse layout and amperage ratings

■ Engine compartment

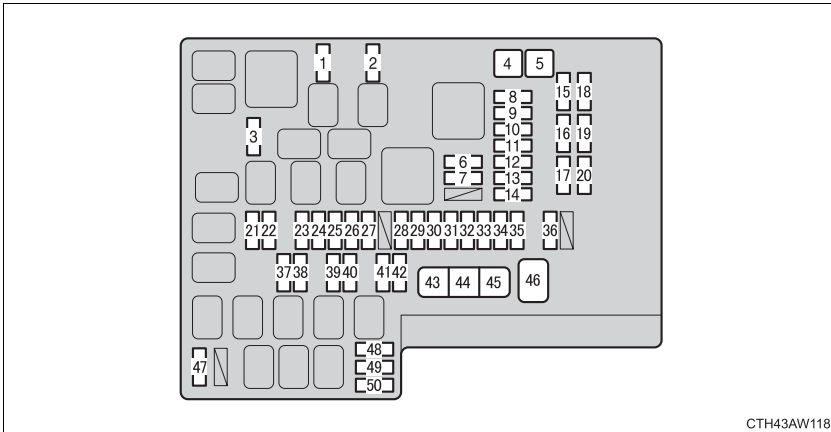

Fuse		Ampere	Circuit
1	MIR HTR	7.5 A	Outside rear view mirror defoggers
2	RDI	25 A	Electric cooling fan
3	(PUSH-AT)	7.5 A	Engine control unit
4	ABS NO. 1	40 A	ABS
5	HEATER	50 A	Air conditioning system
6	WASHER	10 A	Windshield washer
7	WIPER	30 A	Windshield wipers
8	RR DEF	30 A	Rear window defogger
9	(RR FOG)	10 A	Rear fog light
10	D FR DOOR	25 A	Power window (driver's side)
11	(CDS)	25 A	Electric cooling fan
12	D-OP	25 A	—
13	ABS NO. 2	25 A	ABS
14	D FL DOOR	25 A	Power window (passenger's side)
15	SPARE	See note.	Spare fuse

Fuse		Ampere	Circuit
16	SPARE	See note.	Spare fuse
17	SPARE	See note.	Spare fuse
18	SPARE	See note.	Spare fuse
19	SPARE	See note.	Spare fuse
20	SPARE	See note.	Spare fuse
21	ST	7.5 A	Starting system
22	ALT-S	7.5 A	Charging system
23	(STR LOCK)	7.5 A	Steering lock system
24	D/L	20 A	Power door lock
25	ETCS	15 A	Engine control unit
26	(AT+B)	7.5 A	Transmission
27	(AM2 NO. 2)	7.5 A	Smart entry & start system
28	EFI (CTRL)	15 A	Engine control unit
29	EFI (HTR)	15 A	Multiport fuel injection system/ sequential multiport fuel injection system
30	EFI (IGN)	15 A	Starting system
31	EFI (+B)	7.5 A	Engine control unit
32	HAZ	15 A	Turn signal lights, emergency flashers
33	MPX-B	7.5 A	Automatic air conditioning system, gauge and meters
34	F/PMP	20 A	Multiport fuel injection system/ sequential multiport fuel injection system
35	IG2 MAIN	30 A	SRS airbag system, engine control unit
36	DCC	30 A	Interior light, wireless remote con- trol, main body ECU

Fuse		Ampere	Circuit
37	HORN NO. 2	7.5 A	Horn
38	HORN NO. 1	7.5 A	Horn
39	H-LP LH LO	15 A	Left-hand headlight (low beam)
40	H-LP RH LO	15 A	Right-hand headlight (low beam)
41	H-LP LH HI	10 A	Left-hand headlight (high beam)
42	H-LP RH HI	10 A	Right-hand headlight (high beam)
43	INJ	30 A	Multipoint fuel injection system/ sequential multipoint fuel injection system
44	H-LP WASHER	30 A	Headlight cleaners
45	AM2 NO. 1	40 A	Starting system, engine control unit
46	EPS	80 A	Electric power steering
47	A/B MAIN	15 A	SRS airbag system
48	ECU-B	7.5 A	Wireless remote control, main body ECU
49	DOME	20 A	Interior light
50	IG2	7.5 A	Engine control unit

Note

One of each of the following spare fuses are provided: 7.5 A, 10 A, 15 A, 20 A, 25 A, 30 A.

■ Instrument panel

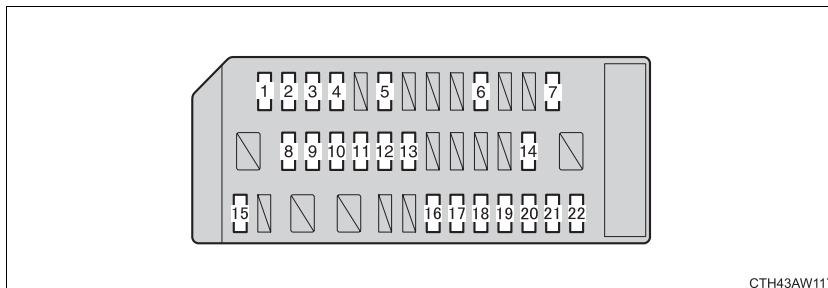

CTH43AW117

	Fuse	Ampere	Circuit
1	ECU ACC	10 A	Main body ECU, outside rear view mirrors
2	P/POINT No.2	15 A	Power outlet
3	PANEL	10 A	Illumination
4	TAIL	10 A	Tail lights
5	DRL	10 A	Daytime running light system
6	STOP	7.5 A	Stop lights
7	OBD	7.5 A	On-board diagnosis system
8	HEATER-S	7.5 A	Air conditioning system
9	HEATER	10 A	Air conditioning system
10	FR FOG LH	10 A	Left-hand front fog light
11	FR FOG RH	10 A	Right-hand front fog light
12	BK/UP LP	7.5 A	Back-up lights
13	ECU IG1	10 A	ABS, electric power steering
14	AM1	7.5 A	Starting system
15	AMP	15 A	Audio system
16	AT UNIT	15 A	Transmission
17	GAUGE	7.5 A	Gauge and meters, smart entry & start system
18	ECU IG2	10 A	Engine control unit
19	SEAT HTR LH	10 A	Left-hand seat heater
20	SEAT HTR RH	10 A	Right-hand seat heater
21	RADIO	7.5 A	Audio system
22	P/POINT No.1	15 A	Power outlet

■ After a fuse is replaced

- If the lights do not turn on even after the fuse has been replaced, a bulb may need replacement. (→P. 344)
- If the replaced fuse blows again, have the vehicle inspected by any authorized Toyota dealer or repairer, or another duly qualified and equipped professional.

■ If there is an overload in the circuits

The fuses are designed to blow, protecting the wiring harness from damage.

⚠ CAUTION**■ To prevent system breakdowns and vehicle fire**

Observe the following precautions.

Failing to do so may cause damage to the vehicle, and possibly a fire or injury.

- Never use a fuse of a higher amperage rating than indicated, or use any other object in place of a fuse.
- Always use a genuine Toyota fuse or equivalent.
- Do not modify the fuse or the fuse box.

⚠ NOTICE**■ Before replacing fuses**

Have the cause of electrical overload determined and repaired by any authorized Toyota dealer or repairer, or another duly qualified and equipped professional.

4-3. Do-it-yourself maintenance

Light bulbs

You may replace the following bulbs by yourself. The difficulty level of replacement varies depending on the bulb. As there is a danger that components may be damaged, we recommend that replacement is carried out by any authorized Toyota dealer or repairer, or another duly qualified and equipped professional.

■ Preparing a replacement light bulb

Check the wattage of the light bulb being replaced. (→P. 446)

■ Front bulb locations

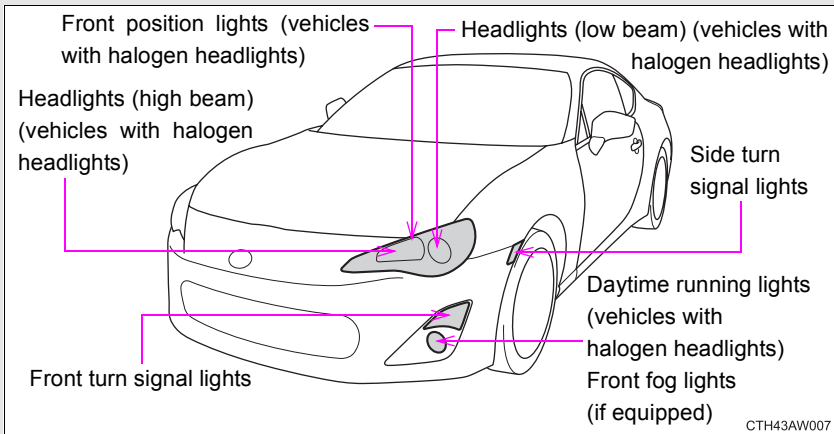

■ Rear bulb locations

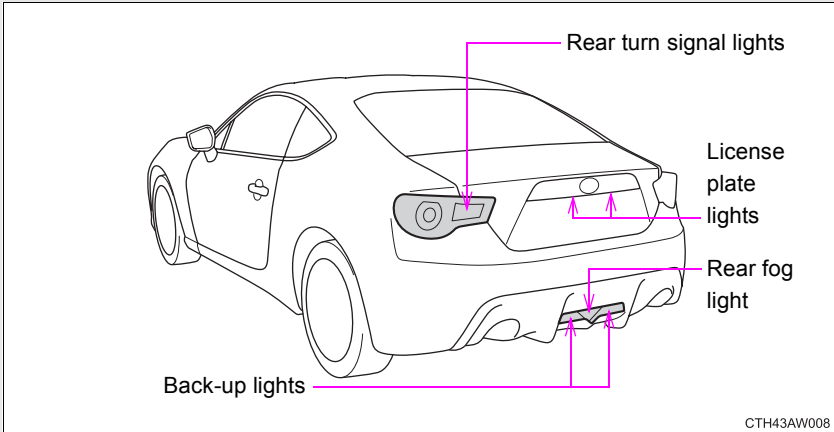

Replacing light bulbs

■ Headlight low beams (vehicles with halogen bulbs)

STEP 1

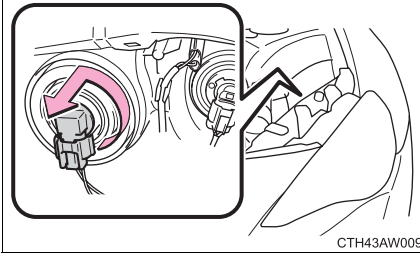

Turn the bulb base counterclockwise.

STEP 2

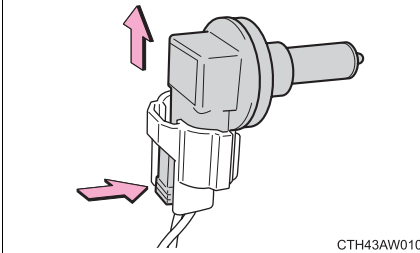

Unplug the connector while depressing the lock release.

STEP 3

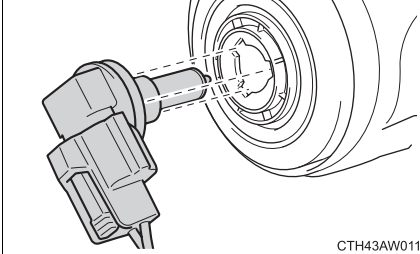

Replace the light bulb, and install the bulb base.

Align the 3 tabs on the light bulb with the mounting, and insert.

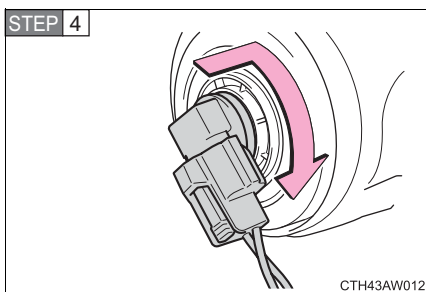

Turn and secure the bulb base.

Shake the bulb base gently to check that it is not loose, turn the headlight low beams on once and visually confirm that no light is leaking through the mounting.

■ Headlight high beams (vehicles with halogen bulbs)

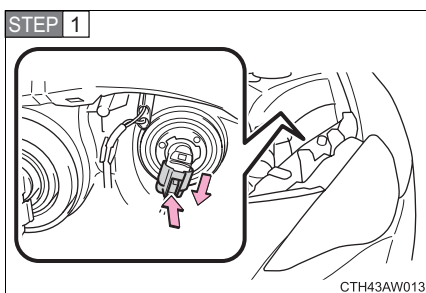

Unplug the connector while depressing the lock release.

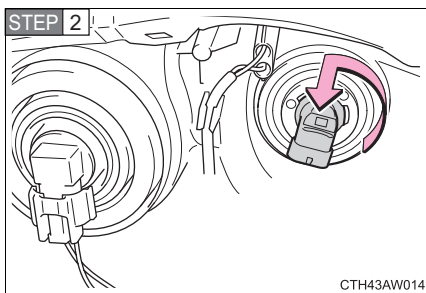

Turn the bulb base counterclockwise.

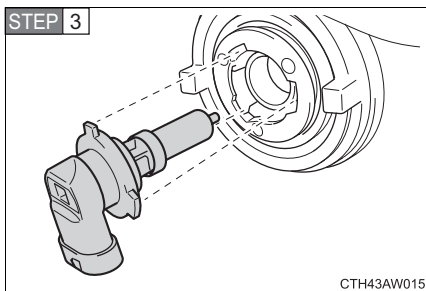

Install a new bulb.

Align the 3 tabs on the light bulb with the mounting, and insert.

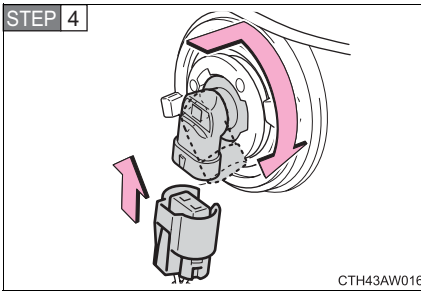

Turn and secure the bulb. Install the connector.

Shake the bulb base gently to check that it is not loose, turn the headlight high beams on once and visually confirm that no light is leaking through the mounting.

■ Front position lights (vehicles with halogen headlights)

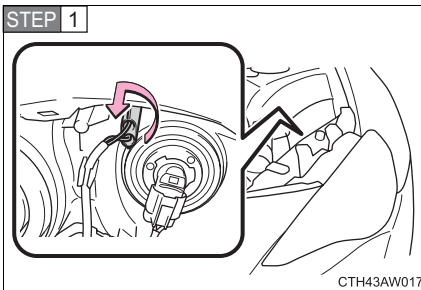

Turn the bulb base counterclockwise.

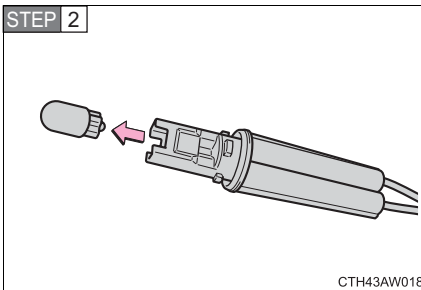

Remove the light bulb.

STEP 3 When installing, reverse the steps listed.

■ Side turn signal lights

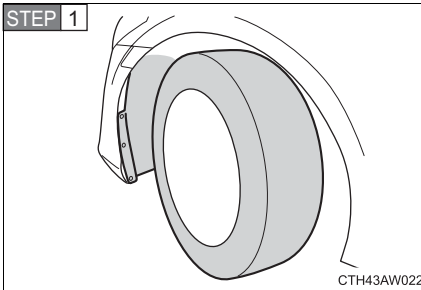

Turn the steering wheel in the opposite direction of the light to be replaced.

Turn the steering wheel to a point that allows your hand to easily fit between the tire and fender liner.

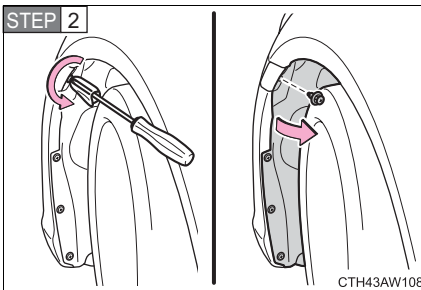

Remove the clip and partly remove the fender liner.

To prevent damage to the vehicle, cover the tip of the screwdriver with a rag.

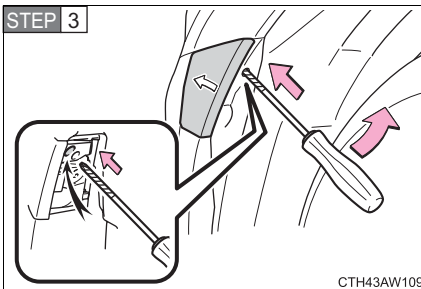

Release the light's claw.

Insert the screwdriver into the hole. While firmly pushing the screwdriver forward, move it towards the inside of the vehicle.

To prevent damage to the vehicle, wrap the tip of the screwdriver with a tape.

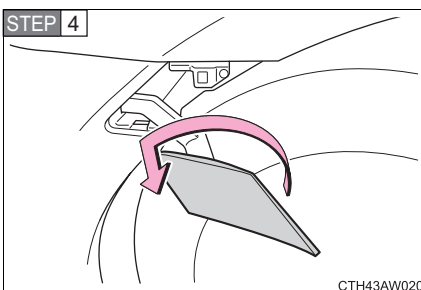

Pull out the lamp and turn the lens counterclockwise.

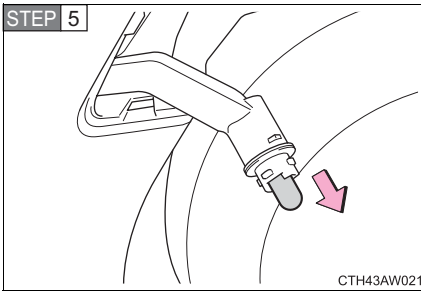

Remove the light bulb.

STEP 6 When installing, reverse the steps listed.

■ Front turn signal lights

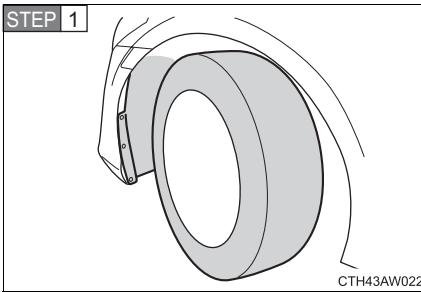

Turn the steering wheel in the opposite direction of the light to be replaced.

Turn the steering wheel to a point that allows your hand to easily fit between the tire and fender liner.

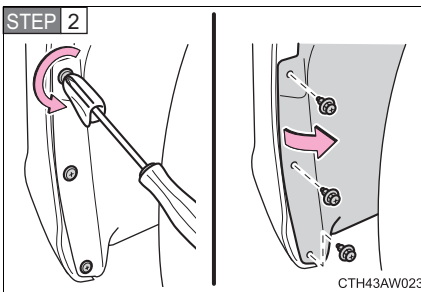

Remove the clips and partly remove the fender liner.

To prevent damage to the vehicle, cover the tip of the screwdriver with a rag.

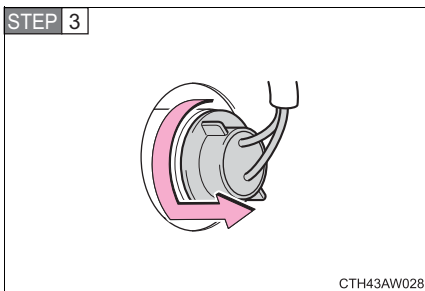

Turn the bulb base counterclockwise.

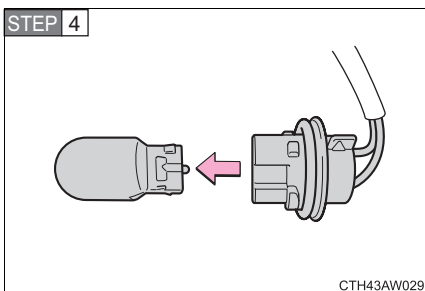

Remove the light bulb.

STEP 5 When installing, reverse the steps listed.

■ **Daytime running lights (vehicles with halogen headlights)/
front fog lights (if equipped)**

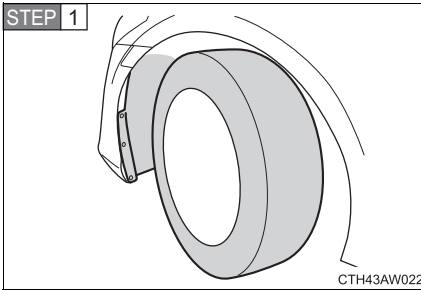

Turn the steering wheel in the opposite direction of the light to be replaced.

Turn the steering wheel to a point that allows your hand to easily fit between the tire and fender liner.

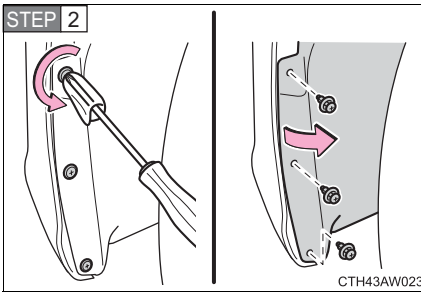

Remove the clips and partly remove the fender liner.

To prevent damage to the vehicle, cover the tip of the screwdriver with a rag.

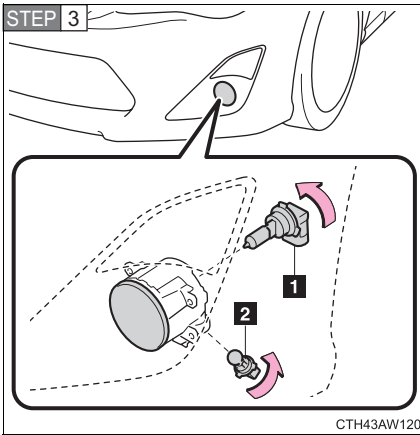

Daytime running lights/front fog lights

- 1** Front fog lights
Unplug the connector and remove the light bulb.
- 2** Daytime running lights
Remove the light bulb.

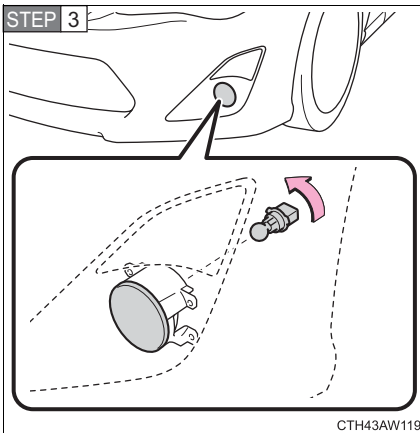

Daytime running lights

Remove the light bulb.

STEP 4 Replace the light bulb with a new one.

STEP 5 **Daytime running lights/front fog lights**

Turn and secure the bulb. Install the connector.

Daytime running lights

Turn and secure the bulb.

STEP 6 When installing the fender liner, install by conducting **STEP 2** with the directions reversed.

■ Front fog lights (vehicles with discharge headlights)

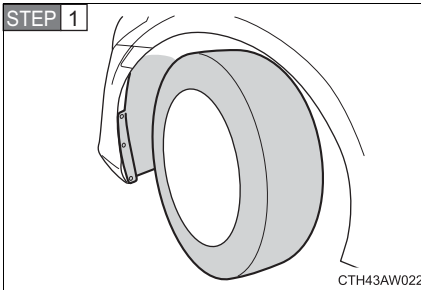

Turn the steering wheel in the opposite direction of the light to be replaced.

Turn the steering wheel to a point that allows your hand to easily fit between the tire and fender liner.

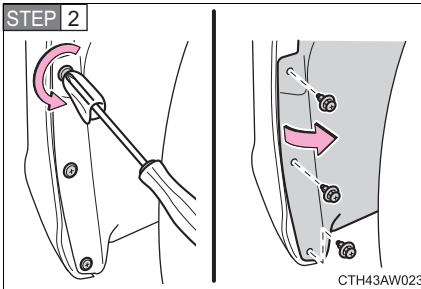

Remove the clips and partly remove the fender liner.

To prevent damage to the vehicle, cover the tip of the screwdriver with a rag.

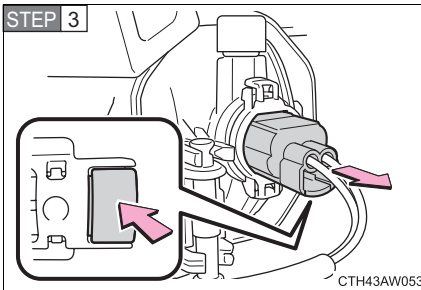

Unplug the connector while depressing the lock release.

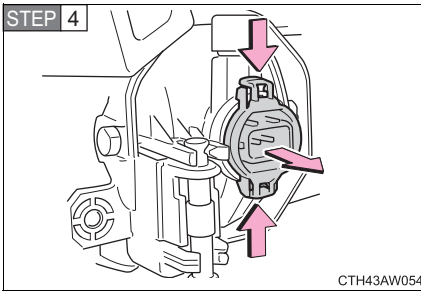

Remove the light bulb.

STEP 5 When installing, reverse the steps listed.

■ Rear turn signal lights

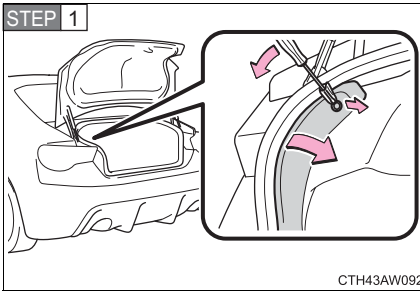

On some models, remove a clip and partly remove the cover.

To prevent damage to the vehicle, cover the tip of the screwdriver with a rag.

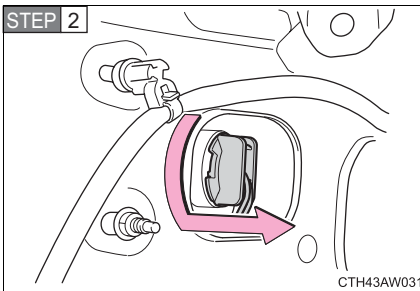

Turn the bulb base counterclockwise.

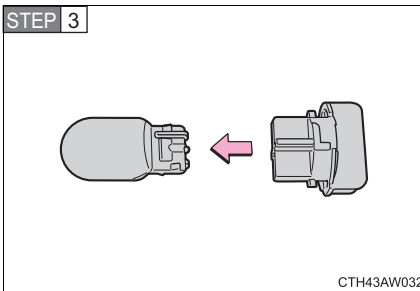

Remove the light bulb.

STEP 4 When installing, reverse the steps listed.

■ Back-up lights

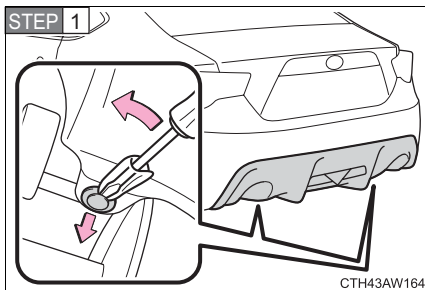

Remove the clips.

To prevent damage to the vehicle, cover the tip of the screwdriver with a rag.

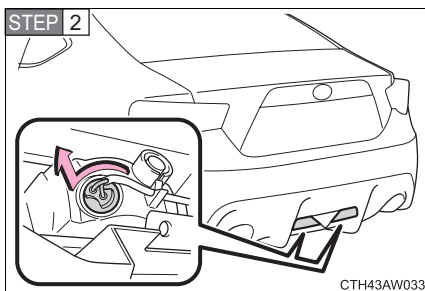

Turn the bulb base counterclockwise.

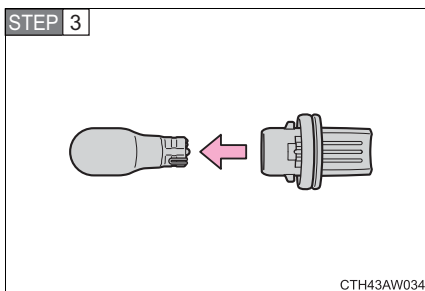

Remove the light bulb.

STEP 4 When installing, reverse the steps listed.

■ Rear fog light

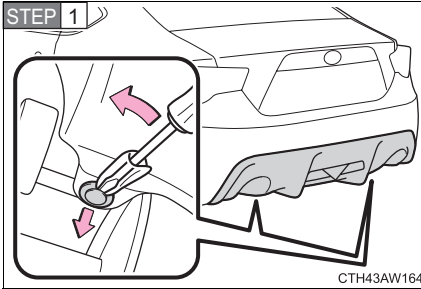

Remove the clips.

To prevent damage to the vehicle, cover the tip of the screwdriver with a rag.

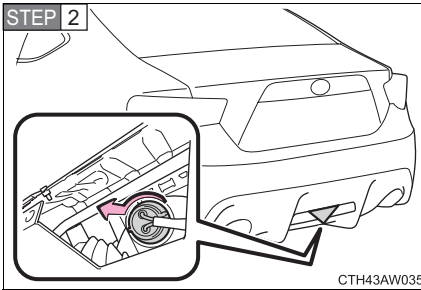

Turn the bulb base counterclockwise.

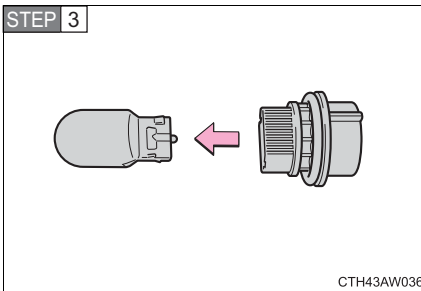

Remove the light bulb.

STEP 4 When installing, reverse the steps listed.

License plate lights

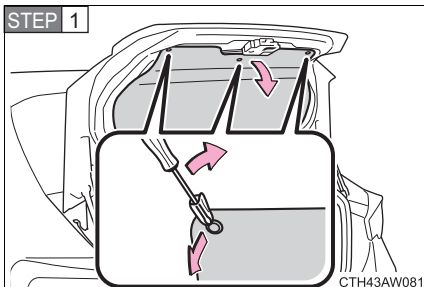

Vehicles with a trunk panel cover: Remove the trunk panel cover clips and partly remove the trunk panel cover.

To prevent damage to the vehicle, cover the tip of the screwdriver with a rag.

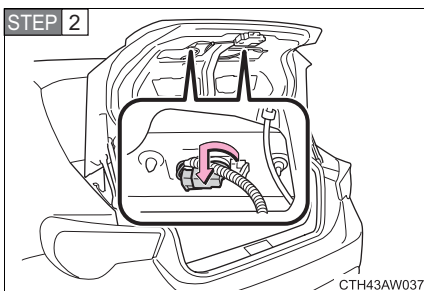

Turn the bulb base counterclockwise.

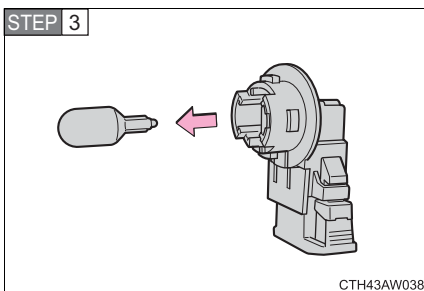

Remove the light bulb.

STEP 4 When installing, reverse the steps listed.

■ Replacing the following bulbs

If any of the lights listed below has burnt out, have it replaced by any authorized Toyota dealer or repairer, or another duly qualified and equipped professional.

- Headlight high and low beams (discharge bulb)
- Front position lights (vehicle with discharge headlights)
- Daytime running lights (vehicle with discharge headlights)
- Stop/tail lights
- High mounted stoplight
- Door courtesy lights

■ Condensation build-up on the inside of the lens

Temporary condensation build-up on the inside of the headlight lens does not indicate a malfunction. Contact any authorized Toyota dealer or repairer, or another duly qualified and equipped professional for more information in the following situations:

- Large drops of water are built up on the inside of the lens.
- Water has built up inside the headlight.

■ Discharge headlights (if equipped)

If voltage to the discharge bulbs is insufficient, the bulbs may not come on, or may go out temporarily. The discharge bulbs will come on when normal power is restored.

■ LED light bulbs

The front position lights (vehicles with discharge headlights), stop/tail lights and high mounted stoplight consist of a number of LEDs. If any of the LEDs burn out, take your vehicle to any authorized Toyota dealer or repairer, or another duly qualified and equipped professional to have the light replaced.

■ When replacing light bulbs

Toyota recommends that you use genuine Toyota products designed for this vehicle.

Because certain bulbs are connected to circuits designed to prevent overload, non-genuine parts or parts not designed for this vehicle may be unusable.

■ Removing and installing the luggage trim cover and trunk panel cover clip

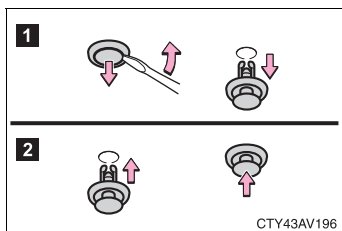

1 Removing

2 Installing

⚠ CAUTION

■ Replacing light bulbs

- Turn off the lights. Do not attempt to replace the bulb immediately after turning off the lights.
The bulbs become very hot and may cause burns.
- Do not touch the glass portion of the light bulb with bare hands. When it is unavoidable to hold the glass portion, use and hold with a clean dry cloth to avoid getting moisture and oils on the bulb.
Also, if the bulb is scratched or dropped, it may blow out or crack.
- Fully install light bulbs and any parts used to secure them. Failure to do so may result in heat damage, fire, or water entering the headlight unit. This may damage the headlights or cause condensation to build up on the lens.

■ When changing the rear fog light or back-up lights

Stop the engine and wait until the exhaust pipe has cooled sufficiently. The lights are located near the exhaust pipe and touching a hot exhaust pipe can cause burns.



CAUTION

■ **Discharge headlights (if equipped)**

- Contact any authorized Toyota dealer or repairer, or another duly qualified and equipped professional, before replacing the discharge headlights (including light bulbs).
- Do not touch the discharge headlight's high voltage socket when the headlights are turned on.
An extremely high voltage of 25000 V will be discharged and could result in serious injury or death by electric shock.
- Do not attempt to take apart or repair the low beam discharge headlight bulbs, connectors, power supply circuits, or related components.
Doing so could result in electric shock and serious injury or death.

■ **To prevent damage or fire**

Make sure bulbs are fully seated and locked.

When trouble arises

5

5-1. Essential information

Emergency flashers.....	364
If your vehicle needs to be towed.....	365
If you think something is wrong.....	372
Fuel pump shut off system.....	373

5-2. Steps to take in an emergency

If a warning light turns on or a warning buzzer sounds.....	374
If you have a flat tire (vehicles with a spare tire).....	386
If you have a flat tire (vehicles with an emergency tire puncture repair kit).....	395
If the engine will not start.....	411
If the shift lever cannot be shifted from P.....	414
If you lose your keys.....	415
If the electronic key does not operate properly.....	416
If the battery is discharged.....	420
If your vehicle overheats.....	425
If the vehicle becomes stuck.....	428
If your vehicle has to be stopped in an emergency.....	430

5-1. Essential information

Emergency flashers

The emergency flashers are used to warn other drivers when the vehicle has to be stopped in the road due to a breakdown, etc.

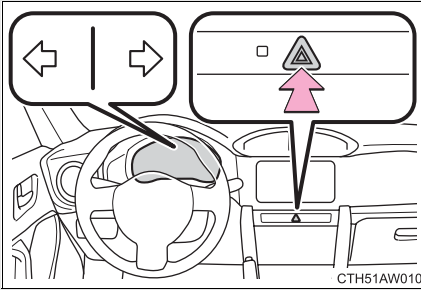

Press the switch.

All the turn signal lights will flash. To turn them off, press the switch once again.

■ Emergency flashers

If the emergency flashers are used for a long time while the engine is not operating, the battery may discharge.

5-1. Essential information

If your vehicle needs to be towed

If towing is necessary, we recommend having your vehicle towed by any authorized Toyota dealer or repairer, or another duly qualified and equipped professional or a commercial towing service, using a lift-type truck or a flat bed truck.

Use a safety chain system for all towing, and abide by all state/provincial and local laws.

If towing from the rear, the vehicle's front wheels and axles must be in good condition. (→P. 370)

If they are damaged, use a towing dolly or flat bed truck.

Before towing

The following may indicate a problem with your transmission. Contact any authorized Toyota dealer or repairer, or another duly qualified and equipped professional before towing.

- The engine is running, but the vehicle will not move.
- The vehicle makes an abnormal sound.

Emergency towing

If a tow truck is not available in an emergency, your vehicle may be temporarily towed using a cable or chain secured to the emergency towing eyelet. This should only be attempted on hard surfaced roads for short distances at low speeds.

A driver must be in the vehicle to steer and operate the brakes. The vehicle's wheels, drive train, axles, steering and brakes must be in good condition.

For vehicles with an automatic transmission, only the front towing eyelet may be used.

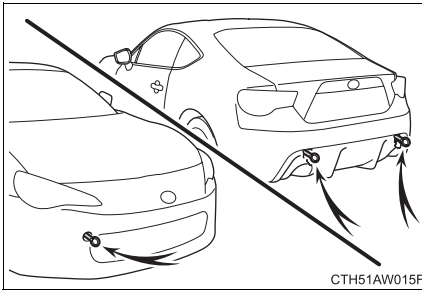

Towing eyelet

■ Before emergency towing

STEP 1 Release the parking brake.

STEP 2 Shift the shift lever to N.

STEP 3 Vehicles without a smart entry & start system: Turn the engine switch to the “ACC” (engine off) or “ON” (engine running) position.

Vehicles with a smart entry & start system: Turn the “ENGINE START STOP” switch to ACCESSORY (engine off) or IGNITION ON (engine running) mode.

■ If towing a vehicle

Do not tow another vehicle. If towing a vehicle that has broken down is unavoidable, avoid towing a vehicle that is heavier than your vehicle. Also, do not pull out a vehicle that has fallen into a ditch.

⚠ CAUTION

■ Caution while towing

- Use extreme caution when towing the vehicle.
Avoid sudden starts or erratic driving maneuvers which place excessive stress on the emergency towing eyelets and the cables or chains. Always be cautious of the surroundings and other vehicles while towing.
- If the engine is not running, the power assist for the brakes and steering will not function, making steering and braking more difficult.

 NOTICE

■ **To prevent causing serious damage to the transmission in emergency towing (vehicles with an automatic transmission)**

Never tow a vehicle from the rear with four wheels on the ground. This may cause serious damage to the transmission.

■ **To prevent damage to the vehicle**

● When towing this vehicle, make sure to observe the following:

- Do not use a wire rope
- Keep vehicle speed below 30 km/h (20 mph) and do not tow for distances over 30 km (19 miles)
- Tow the vehicle in the forward direction
- Do not apply rope to the vehicle's suspension and so forth

● Do not tow another vehicle, boat (trailer) and so forth, that is heavier than this vehicle.

■ **When towing down a long slope**

Use a wheel lift-type or flat bed truck. (→P. 370, 371)

If a wheel lift-type or flat bed truck is not used, the brakes may overheat, leading to poor brake performance.

Installing towing eyelet

STEP 1 Remove the eyelet cover using a flathead screwdriver.

To protect the bodywork, place a rag between the screwdriver and the vehicle body, as shown in the illustration.

Front

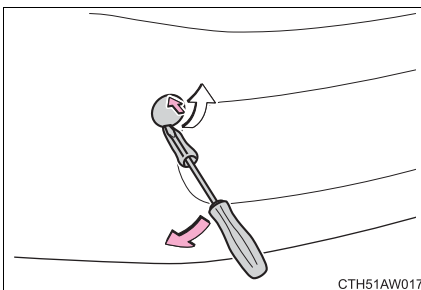

Rear

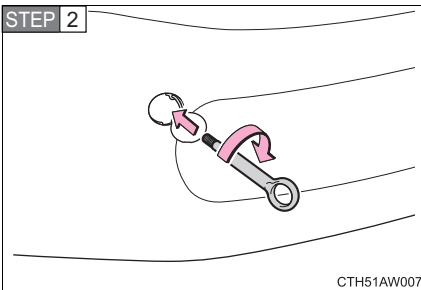
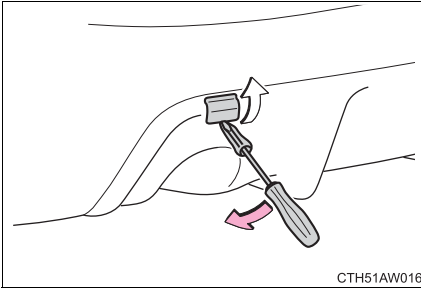

Insert the towing eyelet into the hole and tighten partially by hand.

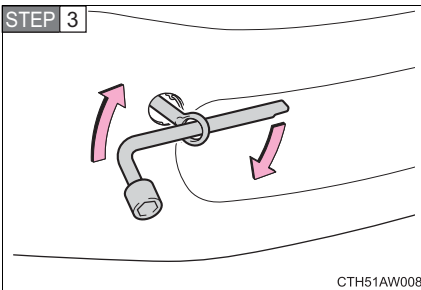

Tighten down the towing eyelet securely using a wheel nut wrench.

■ Location of the emergency towing eyelet

→P. 386, 396

⚠ CAUTION

■ Installing towing eyelets to the vehicle

Make sure that towing eyelet is installed securely.

If not securely installed, towing eyelets may come loose during towing. This may lead to accidents that cause serious injury or even death.

■ After towing

Always remove the towing eyelet. Failure to do so can cause the SRS air-bags to not operate correctly in the event of a frontal collision.

Towing with a sling-type truck

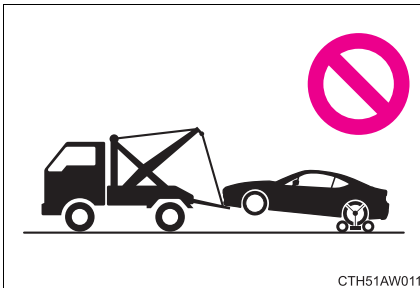

⚠ NOTICE

■ To prevent body damage

Do not tow with a sling-type truck, either from the front or rear.

Towing with a wheel lift-type truck

From the front

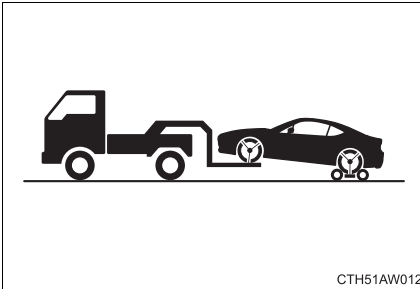

Vehicles with an automatic transmission: Use a towing dolly under the rear wheels.

Vehicles with a manual transmission: We recommend using a towing dolly under the rear wheels.

When not using a towing dolly, release the parking brake and shift the shift lever to N.

From the rear

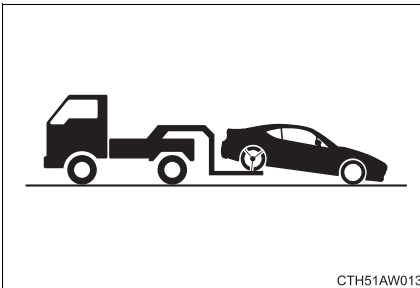

Vehicles without a smart entry & start system: Turn the engine switch to the “ACC” position so that the steering wheel is unlocked.

Vehicles with a smart entry & start system: Turn the “ENGINE START STOP” switch to ACCESSORY mode so that the steering wheel is unlocked.

 NOTICE

■ **To prevent causing serious damage to the transmission when towing using a wheel-lift type truck (vehicles with an automatic transmission)**

Never tow this vehicle from the front with the rear wheels on the ground.

■ **To prevent damaging the vehicle**

- Vehicles without a smart entry & start system: Do not tow the vehicle from the rear when the engine switch is in the “LOCK” position or the key is removed. The steering lock mechanism is not strong enough to hold the front wheels straight.
- Vehicles with a smart entry & start system: Do not tow the vehicle from the rear when the “ENGINE START STOP” switch is off. The steering lock mechanism is not strong enough to hold the front wheels straight.
- When raising the vehicle from the rear, ensure adequate ground clearance for towing at the opposite end of the raised vehicle. Without adequate clearance, the vehicle could be damaged while being towed from the rear.

Using a flat bed truck

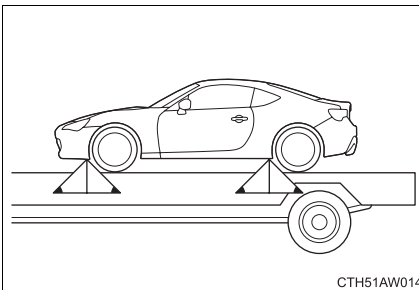

If you use chains or cables to tie down your vehicle, the angles shaded in black must be 45°.

Do not overly tighten the tie downs or the vehicle may be damaged.

If you think something is wrong

If you notice any of the following symptoms, your vehicle probably needs adjustment or repair. Contact any authorized Toyota dealer or repairer, or another duly qualified and equipped professional as soon as possible.

■ Visible symptoms

- Fluid leaks under the vehicle
(Water dripping from the air conditioning after use is normal.)
- Flat-looking tires or uneven tire wear
- Engine coolant temperature gauge needle continually points higher than normal

■ Audible symptoms

- Changes in exhaust sound
- Excessive tire squeal when cornering
- Strange noises related to the suspension system
- Pinging or other noises related to the engine

■ Operational symptoms

- Engine missing, stumbling or running rough
- Appreciable loss of power
- Vehicle pulls heavily to one side when braking
- Vehicle pulls heavily to one side when driving on a level road
- Loss of brake effectiveness, spongy feeling, pedal almost touches the floor

Fuel pump shut off system

To minimize the risk of fuel leakage when the engine stalls or an air-bag inflates upon collision, the fuel pump shut off system stops supplying fuel to the engine.

Follow the procedure below to restart the engine after the system is activated.

Vehicles without a smart entry & start system

STEP 1 Turn the engine switch to the “ACC” or “LOCK” position.

STEP 2 Restart the engine.

Vehicles with a smart entry & start system

STEP 1 Turn the “ENGINE START STOP” switch to ACCESSORY mode or turn it off.

STEP 2 Restart the engine.



NOTICE

■ Before starting the engine

Inspect the ground under the vehicle.

If you find that fuel has leaked on to the ground, the fuel system has been damaged and is in need of repair. Do not restart the engine.

5-2. Steps to take in an emergency

If a warning light turns on or a warning buzzer sounds...

Calmly perform the following actions if any of the warning lights turn on or flash. If a light turns on or flashes, but then turns off, this does not necessarily indicate a malfunction in the system.



Stop the vehicle immediately. Continuing to drive the vehicle may be dangerous.

The following warning indicates a possible problem in the brake system. Immediately stop the vehicle in a safe place and contact any authorized Toyota dealer or repairer, or another duly qualified and equipped professional.

Warning light	Warning light/Details
	<p>Brake system warning light</p> <ul style="list-style-type: none">• Low brake fluid• Malfunction in the brake system <p>This light also comes on when the parking brake is not released. If the light turns off after the parking brake is fully released the system is operating normally.</p>







Stop the vehicle immediately.

The following warning indicates the possibility of damage to the vehicle that may lead to an accident. Immediately stop the vehicle in a safe place and contact any authorized Toyota dealer or repairer, or another duly qualified and equipped professional.

Warning light	Warning light/Details
	<p>Charging system warning light</p> <p>Indicates a malfunction in the vehicle's charging system.</p>
	<p>Low engine oil pressure warning light</p> <p>Indicates that the engine oil pressure is too low.</p>

Have the vehicle inspected immediately.

Failing to investigate the cause of the following warnings may lead to the system operating abnormally and possibly cause an accident. Have the vehicle inspected by any authorized Toyota dealer or repairer, or another duly qualified and equipped professional immediately.

Warning light	Warning light/Details
	<p>Malfunction indicator lamp Indicates a malfunction in:</p> <ul style="list-style-type: none"> • The electronic engine control system; • The electronic throttle control system; • The electronic automatic transmission control system.
	<p>SRS warning light Indicates a malfunction in:</p> <ul style="list-style-type: none"> • The SRS airbag system; • The seat belt pretensioner system.
	<p>ABS warning light Indicates a malfunction in:</p> <ul style="list-style-type: none"> • The ABS; • The brake assist system.
	<p>Electric power steering warning light (warning buzzer) Indicates a malfunction in the EPS (Electric Power Steering) system.</p>
 <p data-bbox="140 1114 284 1201">(Flashes in yellow for 15 seconds.)</p>	<p>Smart entry & start system indicator light (if equipped) Indicates a malfunction in the smart entry & start system.</p>
	<p>Slip indicator Indicates a malfunction in:</p> <ul style="list-style-type: none"> • The VSC system; • The TRC system
	<p>Automatic headlight leveling system warning light (if equipped) Indicates a malfunction in the automatic headlight leveling system.</p>

Warning light	Warning light/Details
 (Comes on in yellow)	<p>Cruise control indicator light (if equipped) Indicates a malfunction in the cruise control system.</p>

■ **If the malfunction indicator lamp comes on while driving**

The malfunction indicator lamp will come on if the fuel tank becomes completely empty. If the fuel tank is empty, refuel the vehicle immediately. The malfunction indicator lamp will go off after several trips.

If the malfunction indicator lamp does not go off, contact any authorized Toyota dealer or repairer, or another duly qualified and equipped professional as soon as possible.

■ **Electric power steering warning light (warning buzzer)**

The electric power steering warning light may come on and the warning buzzer may sound when the voltage is low or the voltage drops.

 **CAUTION**





■ **When the electric power steering warning light comes on**



The steering wheel may become extremely heavy.

If the steering wheel becomes heavier than usual when operating, hold firmly and operate using more force than usual.

Follow the correction procedures.
--

After taking the specified steps to correct the suspected problem, check that the warning light turns off.

Warning light	Warning light/Details	Correction procedure
	Open door warning light Indicates that a door or the trunk is not fully closed.	Check that both side doors and the trunk are closed.
	Low fuel level warning light Remaining fuel (Approximately 7.0 L [1.8 gal., 1.5 Imp. gal.] or less)	Refuel the vehicle.
 (On the instrument cluster)	Driver's seat belt reminder light (warning buzzer)* Warns the driver to fasten his/her seat belt.	Fasten the seat belt.
 (On the center panel)	Front passenger's seat belt reminder light (warning buzzer)* Warns the front passenger to fasten his or her seat belt.	Fasten the seat belt.

Warning light	Warning light/Details	Correction procedure
	<p>Tire pressure warning light</p> <p>When the light comes on: Low tire inflation pressure such as</p> <ul style="list-style-type: none"> • Natural causes (→P. 379) • Flat tire (→P. 386, 395) 	<p>Adjust the tire inflation pressure (including the spare tire) to the specified level.</p> <p>The light will turn off after a few minutes. In case the light does not turn off even if the tire inflation pressure is adjusted, have the system checked by any authorized Toyota dealer or repairer, or another duly qualified and equipped professional.</p>
	<p>When the light comes on after blinking for 1 minute: Malfunction in the tire pressure warning system (→P. 380)</p>	<p>Have the system checked by any authorized Toyota dealer or repairer, or another duly qualified and equipped professional.</p>
	<p>Automatic transmission fluid temperature warning light (if equipped)</p> <p>Indicates that the automatic transmission fluid temperature is too high.</p>	<p>Stop the vehicle in a safe place and shift the shift lever to P.</p> <p>If the light goes off after a little while, the vehicle can be driven. If the light does not go off, contact any authorized Toyota dealer or repairer, or another duly qualified and equipped professional.</p>

***: Driver's and front passenger's seat belt buzzer:**

The driver's and front passenger's seat belt buzzer sounds to alert the driver and front passenger that his or her seat belt is not fastened. The buzzer sounds for 30 seconds after the vehicle has reached a speed of at least 20 km/h (12 mph). Then, if the seat belt is still unfastened, the buzzer will sound in a different tone for 90 more seconds.

■ Front passenger detection sensor and passenger seat belt reminder and warning buzzer

- If luggage is placed on the front passenger seat, the front passenger detection sensor may cause the warning light to flash and warning buzzer to sound, even if a passenger is not sitting in the seat.
- If a cushion is placed on the seat, the sensor may not detect a passenger, and the warning light may not operate properly.

■ When the tire pressure warning light comes on

Check the tire inflation pressure and adjust to the appropriate level. Pushing the tire pressure warning reset switch will not turn off the tire pressure warning light.

■ The tire pressure warning light may turn on due to natural causes

The tire pressure warning light may turn on due to natural causes such as natural air leaks or tire inflation pressure changes caused by temperature. In this case, adjusting the tire inflation pressure will turn off the warning light (after a few minutes).

■ **If the tire pressure warning system is inoperative**

The tire pressure warning system will be disabled in the following conditions:
(When the condition becomes normal, the system will work properly.)

- If tires not equipped with tire pressure warning valves and transmitters are used.
- If the ID code on the tire pressure warning valves and transmitters is not registered in the tire pressure warning computer.
- If the tire inflation pressure is 380 kPa (3.87 kgf/cm² or bar, 55 psi) or higher.

The tire pressure warning system may be disabled in the following conditions:

(When the condition becomes normal, the system will work properly.)

- If electronic devices or facilities using similar radio wave frequencies are nearby.
- If a radio set at similar frequencies is in use in the vehicle.
- If a window tint that affects the radio wave signals is installed.
- If there is a lot of snow or ice on the vehicle, in particular around the wheels or wheel housings.
- If non-genuine Toyota wheels are used. (Even if you use Toyota wheels, the tire pressure warning system may not work properly with some types of tires.)
- If tire chains are used.
- If a large metallic object which can interfere with signal reception is put in the trunk.

■ **If the tire pressure warning light frequently comes on after blinking for approximately one minute**

If the tire pressure warning light frequently comes on after blinking for approximately one minute when the “ENGINE START STOP” switch is turned to IGNITION ON mode (vehicles with a smart entry & start system) or the engine switch is turned to the “ON” position (vehicles without a smart entry & start system), have it checked by any authorized Toyota dealer or repairer, or another duly qualified and equipped professional.

 CAUTION**■ If the tire pressure warning light comes on**

Be sure to observe the following precautions. Failure to do so could cause loss of vehicle control and result in death or serious injury.

- Stop your vehicle in a safe place as soon as possible. Adjust the tire inflation pressure immediately.
- If the tire pressure warning light comes on even after tire inflation pressure adjustment, it is probable that you have a flat tire. Check the tires. If the tire is flat, change to the spare tire and have the flat tire repaired by the nearest any authorized Toyota dealer or repairer, or another duly qualified and equipped professional.
- Avoid abrupt maneuvering and braking. If the vehicle tires deteriorate, you could lose control of the steering wheel or the brakes.

■ If a blowout or sudden air leakage should occur

The tire pressure warning system may not activate immediately.



 NOTICE**■ To ensure the tire pressure warning system operates properly**





Do not install tires with different specifications or makers, as the tire pressure warning system may not operate properly.

Follow the correction procedures. (vehicles with a smart entry & start system)

After taking the specified steps to correct the suspected problem, check that the warning light goes off.

Interior buzzer	Exterior buzzer	Warning light	Warning light/Details	Correction procedure
Continuous	Continuous	 <p>(Flashes in yellow)</p>	<p>Smart entry & start system indicator light</p> <p>Vehicles with an automatic transmission:</p> <p>The electronic key was carried outside the vehicle and the driver's door was opened and closed while any shift position other than P was selected without turning off the "ENGINE START STOP" switch.</p>	<ul style="list-style-type: none"> • Change the shift position to P. • Bring the electronic key back into the vehicle.

Interior buzzer	Exterior buzzer	Warning light	Warning light/Details	Correction procedure
Once	3 times	 <p>(Flashes in yellow)</p>	<p>Smart entry & start system indicator light</p> <p>Vehicles with an automatic transmission:</p> <p>The electronic key was carried outside the vehicle and the driver's door was opened and closed while the shift position P was selected without turning off the "ENGINE START STOP" switch.</p> <p>Vehicles with a manual transmission:</p> <p>The electronic key was carried outside the vehicle and the driver's door was opened and closed while the shift position N was selected without turning off the "ENGINE START STOP" switch.</p>	<p>Turn the "ENGINE START STOP" switch off or bring the electronic key back into the vehicle.</p>
Once	3 times	 <p>(Flashes in yellow)</p>	<p>Smart entry & start system indicator light</p> <p>Indicates that a door other than the driver's door has been opened and closed with the "ENGINE START STOP" switch in any mode other than off and the electronic key outside of the detection area.</p>	<p>Confirm the location of the electronic key.</p>

Interior buzzer	Exterior buzzer	Warning light	Warning light/Details	Correction procedure
Once	Continuous (5 seconds)	 (Flashes in yellow)	Smart entry & start system indicator light An attempt was made to exit the vehicle with the electronic key and lock the doors without first turning the “ENGINE START STOP” switch off.	Turn the “ENGINE START STOP” switch off and lock the doors again.
Once	—	 (Flashes in yellow for 15 seconds.)	Smart entry & start system indicator light Indicates that the electronic key is not present when attempting to start the engine.	Confirm the location of the electronic key.
Intermittently (7 seconds)	—	 (Flashes in yellow)	Smart entry & start system indicator light An attempt was made to drive when the regular key was not inside the vehicle.	Confirm that the electronic key is inside the vehicle.
Once	—	 (Flashes in yellow for 15 seconds.)	Smart entry & start system indicator light Indicates that the electronic key battery is low.	Replace the battery. (→P. 332)
Once	—	 (Flashes quickly in green for 15 seconds.)	Smart entry & start system indicator light Indicates that the steering lock has not been released.	Release the steering lock. (→P. 175)

Interior buzzer	Exterior buzzer	Warning light	Warning light/Details	Correction procedure
Once	—	 <p>(Flashes in yellow for 15 seconds.)</p>	<p>Smart entry & start system indicator light</p> <p>The electronic key could not be detected in the vehicle even after the “ENGINE START STOP” switch was pressed once.</p>	<p>Vehicles with an automatic transmission: Touch the electronic key to the “ENGINE START STOP” switch while depressing the brake pedal.</p> <p>Vehicles with a manual transmission: Touch the electronic key to the “ENGINE START STOP” switch while depressing with the clutch pedal.</p>

5-2. Steps to take in an emergency

If you have a flat tire (vehicles with a spare tire)

Your vehicle is equipped with a spare tire. The flat tire can be replaced with the spare tire.

■ Before jacking up the vehicle

- Stop the vehicle on a hard, flat surface.
- Set the parking brake.
- Shift the shift lever to P (vehicles with an automatic transmission) or R (vehicles with a manual transmission).
- Stop the engine.
- Turn on the emergency flashers.

■ Location of the spare tire, jack and tools

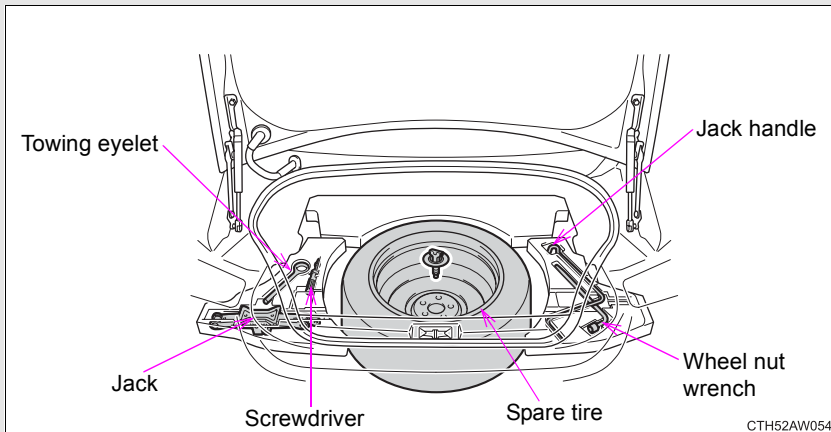

Taking out the spare tire

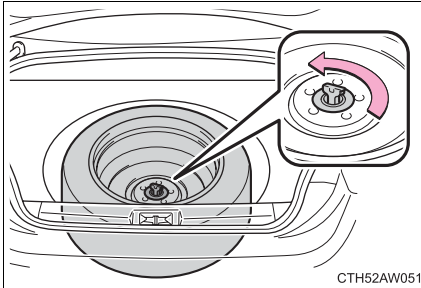

Loosen the center fastener that secures the spare tire.

Replacing a flat tire

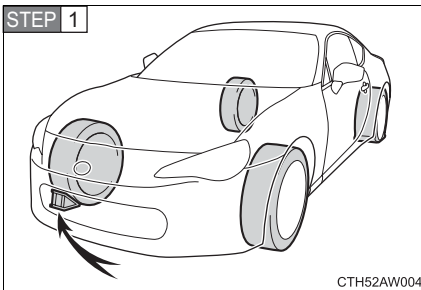

Chock the tires.

Flat tire		Wheel chock positions
Front	Left-hand side	Behind the rear right-hand side tire
	Right-hand side	Behind the rear left-hand side tire
Rear	Left-hand side	In front of the front right-hand side tire
	Right-hand side	In front of the front left-hand side tire

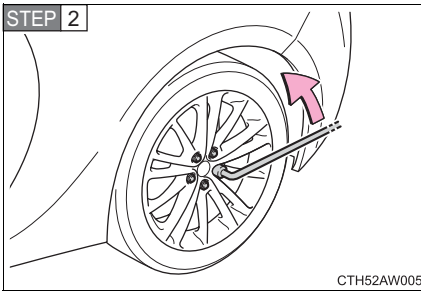

Slightly loosen the wheel nuts (one turn).

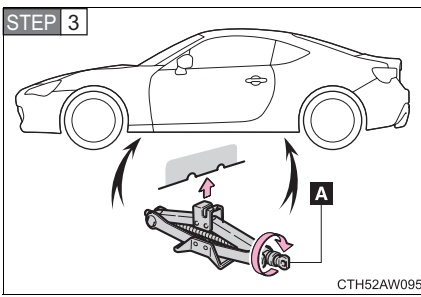

Turn the tire jack portion "A" by hand until the notch of the jack is in contact with the jack point.

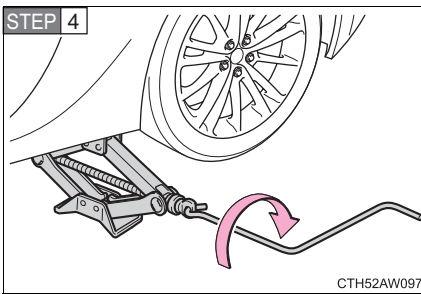

Raise the vehicle until the tire is slightly raised off the ground.

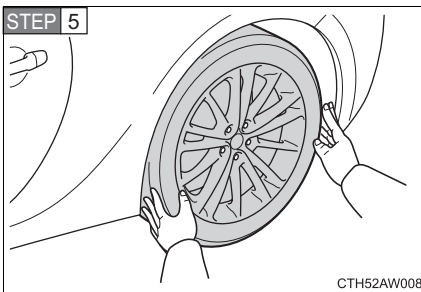

Remove all the wheel nuts and the tire.

When resting the tire on the ground, place the tire so that the wheel design faces up to avoid scratching the wheel surface.

Installing the spare tire

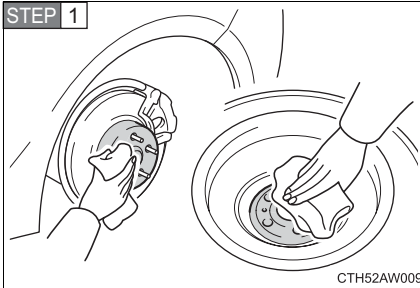

Remove any dirt or foreign matter from the wheel contact surface.

If foreign matter is on the wheel contact surface, the wheel nuts may loosen while the vehicle is in motion, and the tire may come off the vehicle.

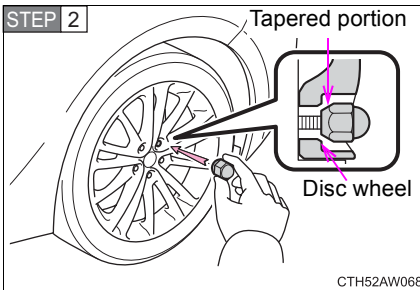

Install the spare tire and loosely tighten each wheel nut by hand to approximately the same amount.

Tighten the wheel nuts until the tapered portion comes into loose contact with the disc wheel.

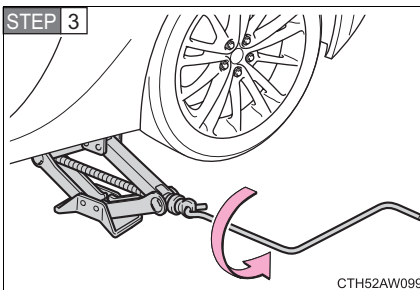

Lower the vehicle.

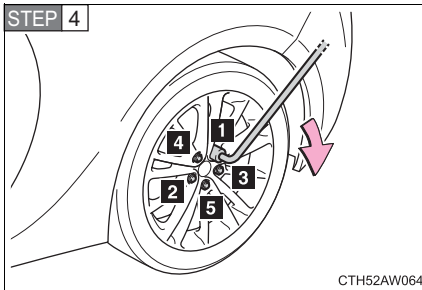

Firmly tighten each nut two or three times in the order shown in the illustration.

Tightening torque:

120 N•m (12.2 kgf•m, 89 ft•lbf)

STEP 5 Stow the flat tire, tire jack and all tools.

■ **After completing the tire change**

The tire pressure warning system must be reset. (→P. 316)

■ **Storing the tire**

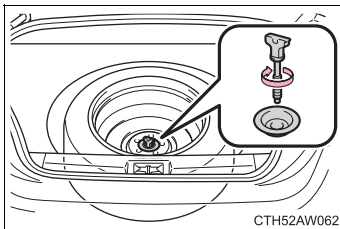

Always install the center fastener as shown in the illustration.

■ Certification for the jack

Manufacturer's Declaration of Conformity

CE

Manufacturer :
1823 Shinmachi Takasaki, Gunma 370 - 1301 Japan
Wako industry Co., Ltd

EU Representative :
—

The EU Directives Covered by this Declaration :
2006 / 42 / EC Machinery

The product covered by this declaration :
Model: JACK SET (97031CA010)

The basis on which conformity is being declared
The product identified above complies with the requirements of the Machinery above by meeting following standards :
ISO9001 / JIS D8103

The technical documentation required to demonstrate that the product meets the requirements of the MACHINERY has been compiled by the signatory below and is available for inspection by the relevant enforcement authorities.

A sample of the product has been tested by the manufacturer.

sign :

*Tanetsu
Sahiguchi*

 CAUTION

■ **Using the tire jack**

Improper use of the tire jack may lead to death or serious injuries due to the vehicle suddenly falling off the jack.

- Do not use the tire jack for any purpose other than replacing tires or installing and removing tire chains.
- Only use the tire jack that comes with this vehicle for replacing a flat tire. Do not use it on other vehicles, and do not use other tire jacks for replacing tires on this vehicle.
- Always check that the tire jack is securely set to the jack point.
- Do not put any part of your body under the vehicle supported by a jack.
- Do not start or run the engine while your vehicle is supported by the jack.
- Do not raise the vehicle while someone is in it.
- When raising the vehicle, do not put an object on or under the jack.
- Do not raise the vehicle to a height greater than that required to replace the tire.
- Use a jack stand if it is necessary to get under the vehicle.

Take particular care when lowering the vehicle to ensure that no one working on or near the vehicle may be injured.

 CAUTION**■ Replacing a flat tire**

- Do not touch the disc wheels or the area around the brakes immediately after the vehicle has been driven.
After the vehicle has been driven the disc wheels and the area around the brakes will be extremely hot. Touching these areas with hands, feet or other body parts while changing a tire, etc. may result in burns.
- Do not attach a heavily damaged wheel ornament, as it may fly off the wheel while the vehicle is moving.
- Failure to follow these precautions could cause the wheel nuts to loosen and the tire to fall off, resulting in death or serious injury.
 - Have the wheel nuts tightened with a torque wrench to 120 N•m (12.2 kgf•m, 89 ft•lbf) as soon as possible after changing wheels.
 - When installing a tire, only use wheel nuts that have been specifically designed for that wheel.
 - If there are any cracks or deformations in the bolt screws, nut threads or bolt holes of the wheel, have the vehicle inspected by any authorized Toyota dealer or repairer, or another duly qualified and equipped professional.
 - When installing the wheel nuts, be sure to install them with the tapered ends facing inward. (→P. 327)



NOTICE

■ **Do not drive the vehicle with a flat tire.**

Do not continue driving with a flat tire.

Driving even a short distance with a flat tire can damage the tire and the wheel beyond repair.

■ **Stowing the jack**

When stowing the jack in the jack holder, make sure that the part that the jack handle attaches to is pointing towards the inside of the trunk. Failure to do so may damage the vehicle body.

■ **When replacing the tires**

When removing or fitting the wheels, tires or the tire pressure warning valve and transmitter, contact any authorized Toyota dealer or repairer, or another duly qualified and equipped professional as the tire pressure warning valve and transmitter may be damaged if not handled correctly.

■ **To avoid damage to the tire pressure warning valves and transmitters**

When a tire is repaired with liquid sealants, the tire pressure warning valve and transmitter may not operate properly. If a liquid sealant is used, contact any authorized Toyota dealer or repairer, or another duly qualified and equipped professional or other qualified service shop as soon as possible. Make sure to replace the tire pressure warning valve and transmitter when replacing the tire. (→P. 316)

5-2. Steps to take in an emergency

If you have a flat tire (vehicles with an emergency tire puncture repair kit)

Your vehicle is not equipped with a spare tire, but instead is equipped with an emergency tire puncture repair kit.

A puncture caused by a nail or screw passing through the tire tread can be repaired temporarily using the emergency tire puncture repair kit. (The kit contains a bottle of sealant. The sealant can be used only once to temporarily repair one tire without removing the nail or screw from the tire.) Depending on the damage, this kit cannot be used to repair the tire. (→P. 398)

After temporarily repairing the tire with the kit, have the tire repaired or replaced by any authorized Toyota dealer or repairer, or another duly qualified and equipped professional. Repairs conducted using the emergency tire puncture repair kit are only a temporary measure. Have the tire repaired and replaced as soon as possible.

■ Before repairing the tire

- Stop the vehicle in a safe place on a hard, flat surface.
- Set the parking brake.
- Shift the shift lever to P (vehicles with an automatic transmission) or N (vehicles with a manual transmission).
- Stop the engine.
- Turn on the emergency flashers.

■ Location of the emergency tire puncture repair kit, jack and tools

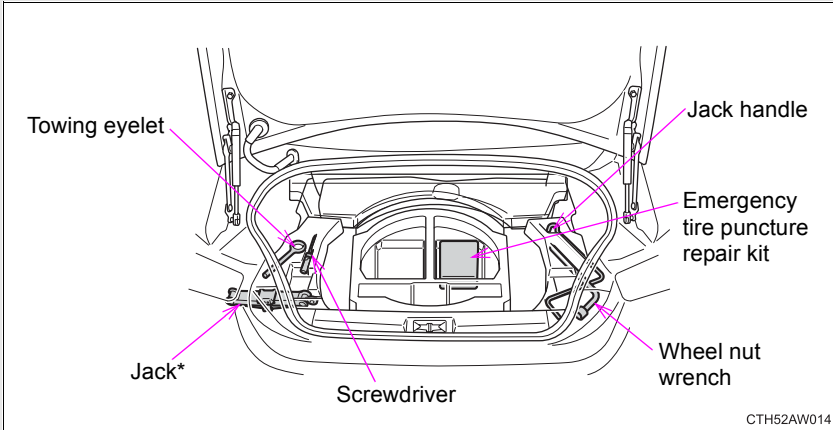

*: Use of the jack (→P. 387)

■ Contents

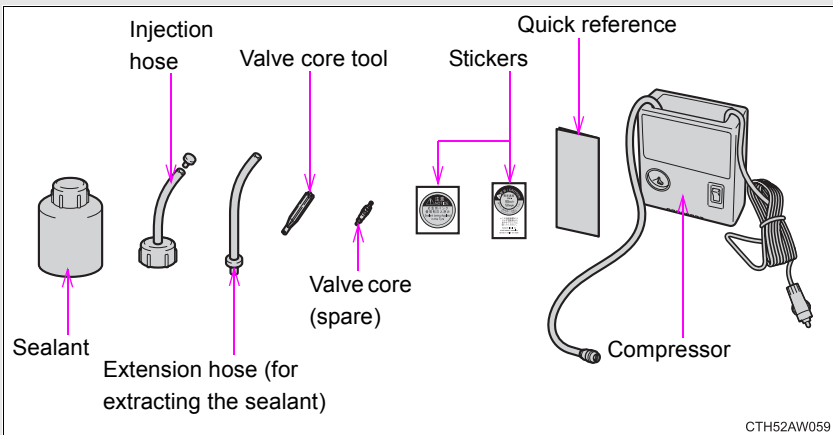

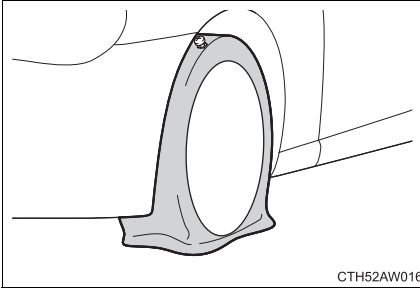
Before performing emergency repair

Check the degree of the tire damage.

- Do not remove the nail or screw from the tire. Removing the object may widen the opening and prevent emergency repair with the repair kit.
- To avoid sealant leakage, move the vehicle until the area of the puncture, if known, is positioned at the top of the tire.

■ **In the following cases, the tire cannot be repaired with the emergency tire puncture repair kit. Contact any authorized Toyota dealer or repairer, or another duly qualified and equipped professional.**

- When the tire is damaged due to driving without sufficient air pressure
- When there are any cracks or damage at any location on the tire, such as on the side wall, except the tread
- When the tire is visibly separated from the wheel
- When the cut or damage to the tread is 4 mm (0.16 in.) long or more
- When the wheel is damaged
- When two or more tires have been punctured (the sealant can be used only once to temporarily repair one tire)
- When more than 2 sharp objects such as nails or screws have passed through the tread on a single tire
- When the sealant has expired

Taking out the emergency tire puncture repair kit

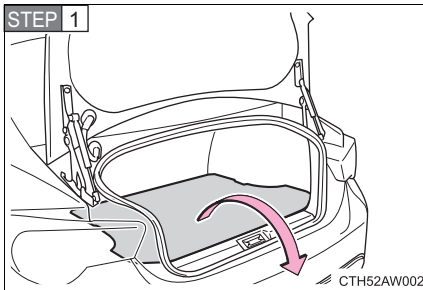

Vehicles with a luggage mat:
Remove the luggage mat.

STEP 2 Take out the emergency tire puncture repair kit.

Emergency repair method

STEP 1 Shake the sealant bottle up and down several times and remove the cap of the sealant bottle.

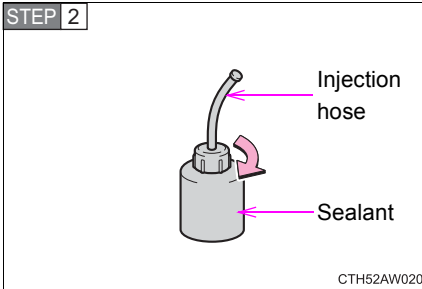

Connect the injection hose by screwing onto the sealant. As it is screwed in, the aluminum seal on the bottle will be torn.

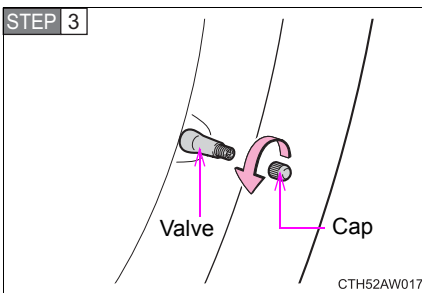

Position the nail or screw that has punctured the tire at the bottom, in contact with the ground. Remove the cap from the valve.

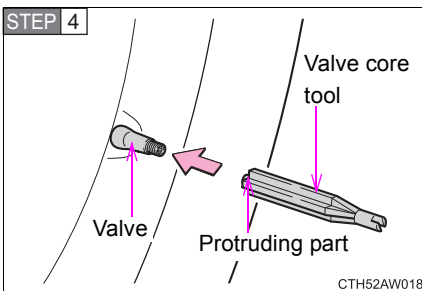

Bring the protruding part of the valve core tool into contact with the valve to discharge air.

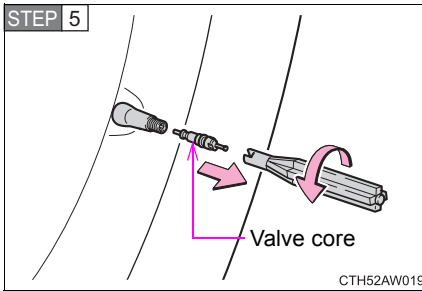

Pull out the valve core by turning it counterclockwise using the valve core tool.

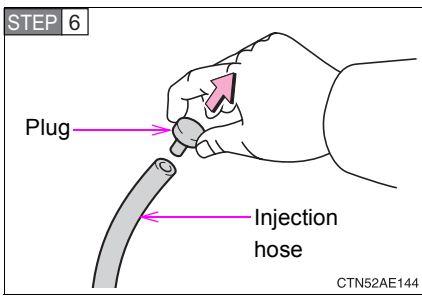

Remove the plug from the injection hose.

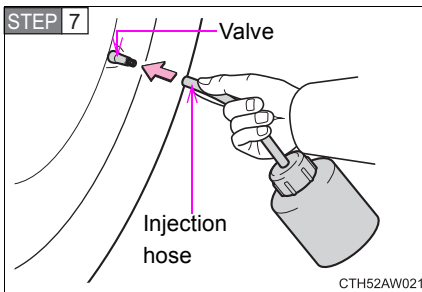

Connect the injection hose to the valve.

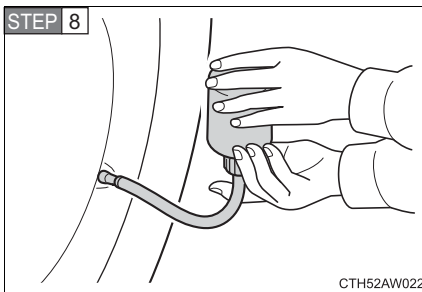

Inject the sealant that is in the bottle. Hold and tilt the bottle, then squeeze sealant out of the bottle as shown.

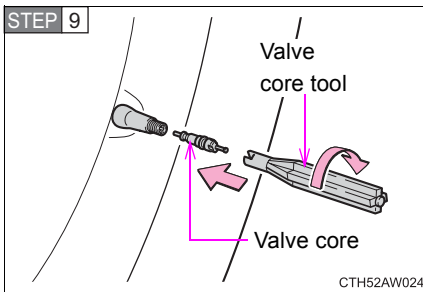

Remove the injection hose from the valve and screw the valve core in the valve securely by turning it clockwise with the valve core tool.

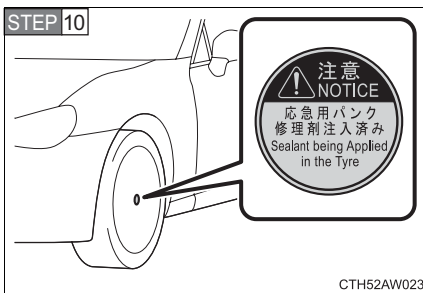

Attach the sticker as shown.

Remove any dirt and moisture from the wheel before attaching the label. If it is impossible to attach the label, make sure to tell any authorized Toyota dealer or repairer, or another duly qualified and equipped professional when you have them repair and replace the tire that sealant is injected.

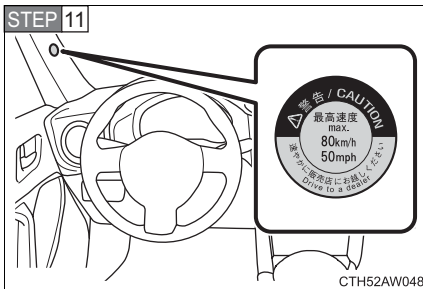

Store the kit and then attach the sticker as shown.

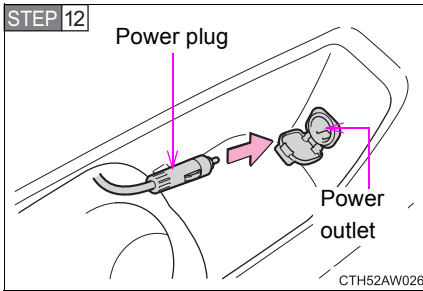

Connect the compressor power plug to the power outlet.

Vehicles without a smart entry & start system: The engine switch must be in the "ACC" position.

Vehicles with a smart entry & start system: The "ENGINE START STOP" switch must be in ACCESSORY mode.

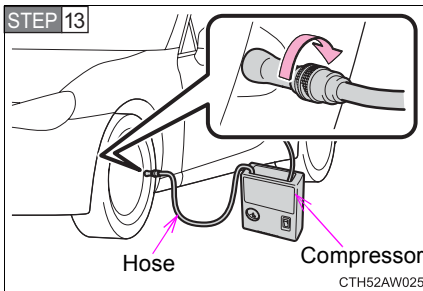

Connect the air compressor hose by threading it on the valve.

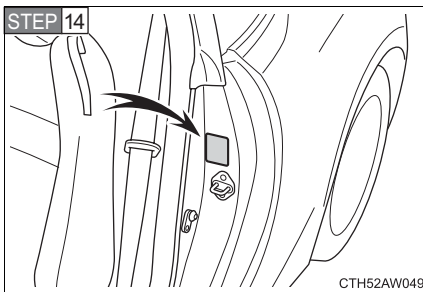

Left-hand drive vehicles: Check the specified inflation pressure.

The label is placed as shown in the illustration.

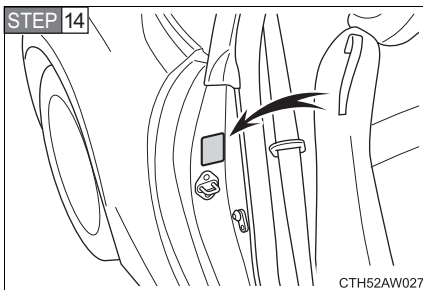

Right-hand drive vehicles: Check the specified inflation pressure.

The label is placed as shown in the illustration.

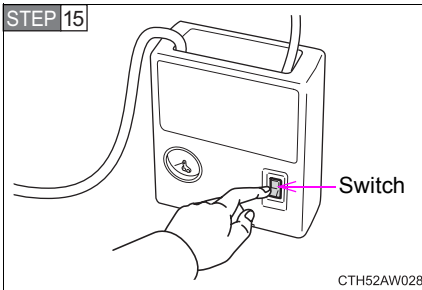

Turn the compressor switch “ON” and fill the tire with air until the specified inflation pressure is reached.

STEP 16 Turn the switch “OFF” when the pressure gauge connected to the hose reads the specified pressure.

If the inflation pressure is not attained within 10 minutes, emergency repair is not possible due to severe damage. Contact any authorized Toyota dealer or repairer, or another duly qualified and equipped professional.

STEP 17 After completely filling the tire with air, disconnect the hose from the valve on the tire and pull the power plug of the compressor out of the power outlet on the vehicle.

STEP 18 To spread the liquid sealant evenly in the tire, immediately drive for about 10 minutes.

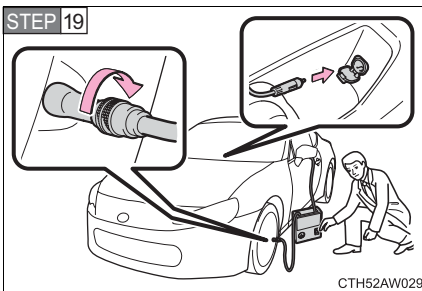

After driving about 10 minutes, pull your vehicle over in a safe place and reconnect the compressor.

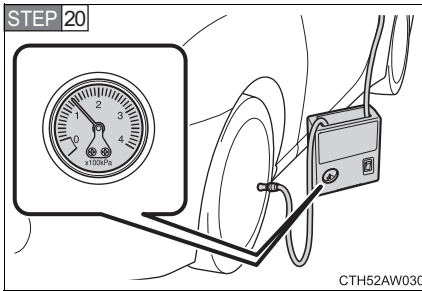

Read the inflation pressure on the pressure gauge.

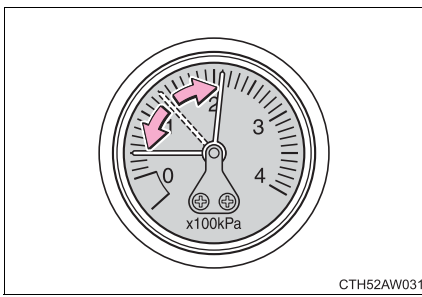

If the pressure is 130 kPa (1.3 kgf/cm² or bar, 19 psi) or above, fill the tire with air using the compressor until the specified inflation pressure is reached.

If the pressure is less than 130 kPa (1.3 kgf/cm² or bar, 19 psi), the emergency repair that have been performed is not safe for use as damage to the tire is too severe. Do not continue to drive the vehicle. Contact any authorized Toyota dealer or repairer, or another duly qualified and equipped professional.

STEP 21 Taking precautions to avoid sudden braking, sudden acceleration and sharp turns, drive carefully at under 80 km/h (50 mph) to the nearest authorized Toyota dealer or repairer, or another duly qualified and equipped professional for tire repair or replacement.

■ After a tire is repaired with the emergency tire puncture repair kit

- The tire pressure warning valve and transmitter should be replaced.
- Even if the tire inflation pressure is at the recommended level, the tire pressure warning light may come on/flash.

■ Note for checking the emergency tire puncture repair kit

Check the sealant expiry date occasionally.

The expiry date is shown on the bottle. Do not use sealant whose expiry date has already passed. Otherwise, repairs conducted using the emergency tire puncture repair kit may not be performed properly.

■ Emergency tire puncture repair kit

- The sealant stored in the emergency tire puncture repair kit can be used only once to temporarily repair a single tire. If the sealant has been used and needs to be replaced, purchase a new bottle at any authorized Toyota dealer or repairer, or another duly qualified and equipped professional. The compressor is reusable.
- The sealant can be used when the outside temperature is -40°C (-40°F) or more.
- The repair kit is exclusively designed for size and type of tires originally installed on your vehicle. Do not use it for tires that a different size than the original ones, or for any other purposes.
- The sealant has a limited lifespan. The expiry date is marked on the bottle. The bottle of sealant should be replaced with a new bottle before the expiry date. Contact any authorized Toyota dealer or repairer, or another duly qualified and equipped professional for replacement.
- If the sealant gets on your clothes, it may stain.
- If the sealant adheres to a wheel or the surface of the vehicle body, the stain may not be removable if it is not cleaned at once. Immediately wipe away the sealant with a wet cloth.
- During operation of the repair kit, a loud operation noise is produced. This does not indicate a malfunction.
- Do not use to check or to adjust the tire pressure.

 **CAUTION**

■ **Do not drive the vehicle with a flat tire**

Do not continue driving with a flat tire.

Driving even a short distance with a flat tire can damage the tire and the wheel beyond repair.

Driving with a flat tire may cause a circumferential groove on the side wall. In such a case, the tire may explode when using a repair kit.

■ **Caution while driving**

- Store the repair kit in the trunk.

Injuries may result in the event of an accident or sudden braking.

- The repair kit is exclusively only for your vehicle.

Do not use repair kit on other vehicles, which could lead to an accident causing death or serious injury.

- Do not use repair kit for tires that are different size than the original ones, or for any other purpose. If the tires have not been completely repaired, it could lead to an accident causing death or serious injury.

■ **Precautions for use of the sealant**

- Ingesting the sealant is hazardous to your health. If you ingest sealant, consume as much water as possible, and then immediately consult a doctor.
- If sealant gets in eyes or adheres to skin, immediately wash it off with water. If discomfort persists, consult a doctor.

 CAUTION**■ When fixing the flat tire**

- Stop your vehicle in a safe and flat area.
- If force is used to turn the valve core tool while air remains in the tire, special care should be taken because the valve core could fly out.
- Be careful, as sealant may fly out if you shake the bottle with the hose installed.
- Do not touch the wheels or the area around the brakes immediately after the vehicle has been driven.
After the vehicle has been driven, the wheels and the area around the brakes may be extremely hot. Touching these areas with hands, feet or other body parts may result in burns.
- Connect the valve and hose securely with the tire installed on the vehicle.
If the hose is not properly connected to the valve, air leakage may occur as sealant may be sprayed out.
- If the hose comes off the valve while inflating the tire, there is a risk that the hose will move abruptly due to air pressure.

 **CAUTION**

■ **When fixing the flat tire**

- After inflation of the tire has completed, the sealant may splatter when the hose is disconnected or some air is let out of the tire.
- Follow the operation procedure to repair the tire. If the procedures not followed, the sealant may spray out.
- Keep back from the tire while it is being repaired, as there is a chance of it bursting while the repair operation is being performed. If you notice any cracks or deformation of the tire, turn off the compressor switch and stop the repair operation immediately.
- The repair kit may overheat if operated for a long period of time. Do not operate the repair kit continuously for more than 10 minutes.
- Parts of the repair kit become hot during operation. Be careful when handling the repair kit during and after operation. Do not touch the metal part around the connecting area between the bottle and compressor. It will be extremely hot.
- Do not attach the vehicle speed warning sticker to an area other than the one indicated. If the sticker is attached to an area where an SRS airbag is located, such as the pad of the steering wheel, it may prevent the SRS airbag from operating properly.

■ **Driving to spread the liquid sealant evenly**

Observe the following precautions to reduce the risk of accidents.

Failing to do so may result in a loss of vehicle control and cause death or serious injury.

- Drive the vehicle carefully at a low speed. Be especially careful when turning and cornering.
- If the vehicle does not drive straight or you feel a pull through the steering wheel, stop the vehicle and check the following.
 - Tire condition. The tire may have separated from the wheel.
 - Tire inflation pressure. If the tire inflation pressure is 130 kPa (1.3 kgf/cm² or bar, 19 psi) or less, the tire may be severely damaged.

 NOTICE**When performing an emergency repair**

- A tire should only be repaired with the emergency tire puncture repair kit if the damage is caused by a sharp object such as nail or screw passing through the tire tread.
Do not remove the sharp object from the tire. Removing the object may widen the opening and disenable emergency repair with the repair kit.
- The repair kit is not waterproof. Make sure that the repair kit is not exposed to water, such as when it is being used in the rain.
- Do not put the repair kit directly onto dusty ground such as sand at the side of the road. If the repair kit vacuums up dust etc., a malfunction may occur.
- Do not put the valve core on dirty ground or in the sand.
Store it in a clean place.
- Do not remove the inside cap of the sealant bottle.
- Turn the valve core tool with your hand when screwing it in. If you use another tool in conjunction with the valve core tool, damage may occur.

Precautions for the emergency tire puncture repair kit

- The repair kit power source should be 12 V DC suitable for vehicle use. Do not connect the repair kit to any other source.
- If gasoline splatters on the repair kit, the repair kit may deteriorate. Take care not to allow gasoline to contact it.
- Place the repair kit in a storage to prevent it from being exposed to dirt or water.
- Store the repair kit in the trunk out of reach of children.
- Do not disassemble or modify the repair kit. Do not subject parts such as the air pressure indicator to impacts. This may cause a malfunction.



NOTICE

■ **To avoid damage to the tire pressure warning valves and transmitters**

When a tire is repaired with liquid sealants, the tire pressure warning valve and transmitter may not operate properly. If a liquid sealant is used, contact any authorized Toyota dealer or repairer, or another duly qualified and equipped professional or other qualified service shop as soon as possible. After use of liquid sealant, make sure to replace the tire pressure warning valve and transmitter when repairing or replacing the tire. (→P. 316)

5-2. Steps to take in an emergency If the engine will not start

If the engine will not start even though correct starting procedures are being followed (→P. 169, 178), consider each of the following points.

■ **The engine will not start even when the starter motor operates normally.**

One of the following may be the cause of the problem.

- There may not be sufficient fuel in the vehicle's tank.
Refuel the vehicle.
- The engine may be flooded.
Try to restart the engine once more following correct starting procedures. (→P. 169, 178)
- There may be a malfunction in the engine immobilizer system.
(→P. 92)

■ **The starter motor turns over slowly, the interior lights and headlights are dim, or the horn does not sound or sounds at a low volume.**

One of the following may be the cause of the problem.

- The battery may be discharged. (→P. 420)
- The battery terminal connections may be loose or corroded.

■ **The starter motor does not turn over. (vehicles with a smart entry & start system)**

The engine starting system may be malfunctioning due to an electrical problem such as an open circuit or a blown fuse. However, an interim measure is available to start the engine.
(→P. 412)

■ **The starter motor does not turn over, the interior lights and headlights do not turn on, or the horn does not sound.**

One of the following may be the cause of the problem.

- One or both of the battery terminals may be disconnected.
- The battery may be discharged. (→P. 420)
- There may be a malfunction in the steering lock system. (vehicles with a smart entry & start system)

Contact any authorized Toyota dealer or repairer, or another duly qualified and equipped professional if the problem cannot be repaired, or if repair procedures are unknown.

Emergency start function (vehicles with a smart entry & start system)

When the engine does not start, the following steps can be used as an interim measure to start the engine if the “ENGINE START STOP” switch is functioning normally:

Vehicles with an automatic transmission

STEP 1 Set the parking brake.

STEP 2 Put the shift lever in P.

STEP 3 Set the “ENGINE START STOP” switch to ACCESSORY mode.

STEP 4 Press and hold the “ENGINE START STOP” switch about 15 seconds while depressing the brake pedal firmly.

Even if the engine can be started using the above steps, the system may be malfunctioning. Have the vehicle checked by any authorized Toyota dealer or repairer, or another duly qualified and equipped professional.

Vehicles with a manual transmission

STEP 1 Set the parking brake.

STEP 2 Put the shift lever in N.

STEP 3 Turn the “ENGINE START STOP” switch to ACCESSORY mode.

STEP 4 Push and hold the “ENGINE START STOP” switch for about 15 seconds while depressing the brake pedal and clutch pedal firmly.

Even if the engine can be started using the above steps, the system may be malfunctioning. Have the vehicle checked by any authorized Toyota dealer or repairer, or another duly qualified and equipped professional.

5-2. Steps to take in an emergency

If the shift lever cannot be shifted from P (vehicles with an automatic transmission)

If the shift lever cannot be shifted with your foot on the brake, there may be a problem with the shift lock system (a system to prevent accidental operation of the shift lever). Have the vehicle inspected by any authorized Toyota dealer or repairer, or another duly qualified and equipped professional immediately.

The following steps may be used as an emergency measure to ensure that the shift lever can be shifted.

STEP 1 Set the parking brake.

STEP 2 Vehicles without a smart entry & start system: Turn the engine switch to the “ACC” position.

Vehicles with a smart entry & start system: Turn the “ENGINE START STOP” switch to ACCESSORY mode.

STEP 3 Depress the brake pedal.

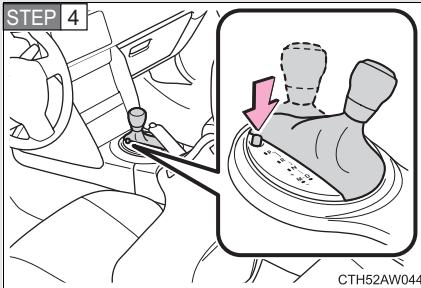

Press the shift lock override button.

The shift lever can be shifted while the button is pressed.

5-2. Steps to take in an emergency

If you lose your keys

New genuine keys can be made by any authorized Toyota dealer or repairer, or another duly qualified and equipped professional. For vehicles without a smart entry & start system, bring a master key and the key number stamped on the key number plate. For vehicles with a smart entry & start system, bring the other key and the key number stamped on the key number plate.

5-2. Steps to take in an emergency

If the electronic key does not operate properly (vehicles with a smart entry & start system)

If communication between the electronic key and vehicle is interrupted (→P. 40) or the electronic key cannot be used because the battery is depleted, the smart entry & start system and wireless remote control cannot be used. In such cases, the doors and trunk can be opened or the engine can be started by following the procedure below.

Unlocking and locking the doors, unlocking the trunk

Use the mechanical key built in to the electronic keys to operate the doors and trunk. (→P. 31)

Doors

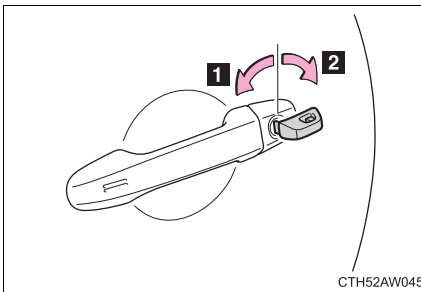

Vehicles without a double locking system

- 1 Locks driver's door
- 2 Unlocks driver's door

Vehicles with a double locking system

- 1 Locks both side doors
- 2 Unlocks both side doors

Trunk (left-hand drive vehicles only)

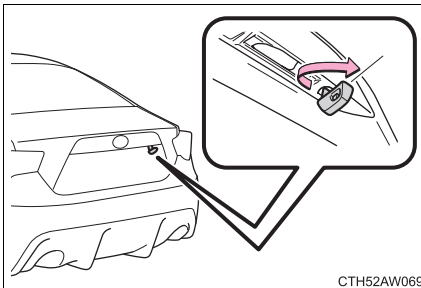

Turn the mechanical key clockwise to open.

Starting the engine

Vehicles with an automatic transmission

STEP 1 Ensure that the shift lever is in P and firmly depress the brake pedal.

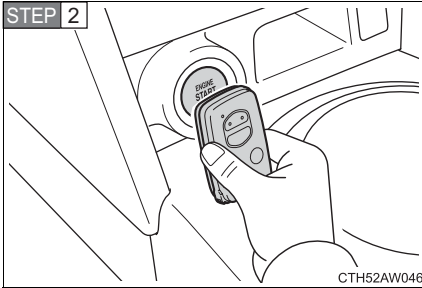

Touch the Toyota emblem side of the electronic key to the “ENGINE START STOP” switch.

When the electronic key is detected, a buzzer sounds and the “ENGINE START STOP” switch will turn to IGNITION ON mode.

When the smart entry & start system is deactivated in customization setting, the “ENGINE START STOP” switch will turn to ACCESSORY mode.

STEP 3 Firmly depress the brake pedal and check that the smart entry & start system indicator light (green) turns on.

STEP 4 Press the “ENGINE START STOP” switch.

In the event that the “ENGINE START STOP” switch still cannot be operated, contact any authorized Toyota dealer or repairer, or another duly qualified and equipped professional.

Vehicles with a manual transmission

STEP 1 Ensure that the shift lever is in N and depress the clutch pedal.

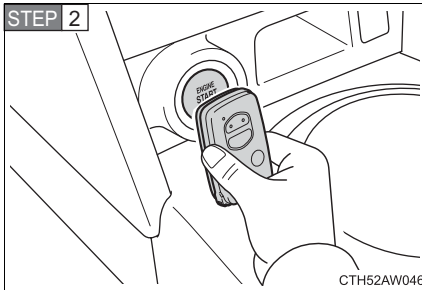

Touch the Toyota emblem side of the electronic key to the “ENGINE START STOP” switch.

When the electronic key is detected, a buzzer sounds and the “ENGINE START STOP” switch will turn to IGNITION ON mode.

When the smart entry & start system is deactivated in customization setting, the “ENGINE START STOP” switch will turn to ACCESSORY mode.

STEP 3 Firmly depress the clutch pedal and check that the smart entry & start system indicator light (green) turns on.

STEP 4 Press the “ENGINE START STOP” switch.

In the event that the “ENGINE START STOP” switch still cannot be operated, contact any authorized Toyota dealer or repairer, or another duly qualified and equipped professional.

■ Stopping the engine

Vehicles with an automatic transmission: Shift the shift lever to P and press the “ENGINE START STOP” switch as you normally do when stopping the engine.

Vehicles with a manual transmission: Shift the shift lever to N and press the “ENGINE START STOP” switch as you normally do when stopping the engine.

■ Replacing the key battery

As the above procedure is a temporary measure, it is recommended that the electronic key battery be replaced immediately when the battery depletes. (→P. 332)

■ Changing “ENGINE START STOP” switch modes

Vehicles with an automatic transmission

Release the brake pedal and press the “ENGINE START STOP” switch in **STEP 3** above. The engine does not start and modes will be changed each time the switch is pressed. (→P. 172)

Vehicles with a manual transmission

Release the clutch pedal and press the “ENGINE START STOP” switch in **STEP 3** above. The engine does not start and modes will be changed each time the switch is pressed. (→P. 172)

■ If the doors cannot be locked or unlocked by the smart entry & start system

Lock and unlock the doors by the mechanical key or wireless remote control.

5-2. Steps to take in an emergency If the battery is discharged

The following procedures may be used to start the engine if the vehicle's battery is discharged.

You can call any authorized Toyota dealer or repairer, or another duly qualified and equipped professional or a qualified repair shop.

If you have a set of jumper (or booster) cables and a second vehicle with a 12-volt battery, you can jump start your vehicle following the steps below.

STEP 1 Connect the jumper cables according to the following procedures:

Left-hand drive vehicles

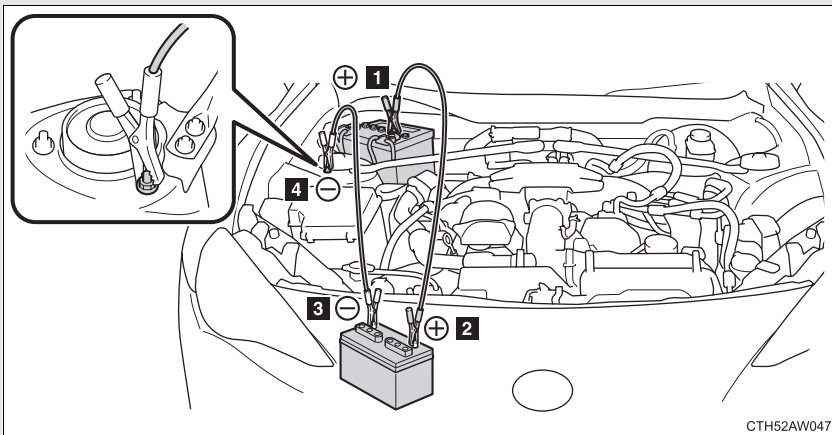

Right-hand drive vehicles

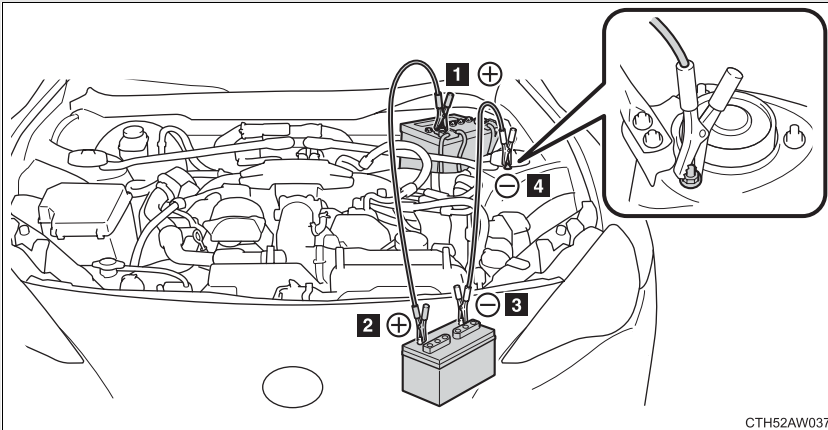

CTH52AW037

- 1** Positive (+) battery terminal on your vehicle
- 2** Positive (+) battery terminal on the second vehicle
- 3** Negative (-) battery terminal on the second vehicle
- 4** Connect the jumper cable to ground on your vehicle as shown in the illustration.

STEP 2 Start the engine of the second vehicle. Increase the engine speed slightly and maintain at that level for approximately 5 minutes to recharge the battery of your vehicle.

STEP 3 Vehicles with a smart entry & start system only: Open and close any of the doors of your vehicle with the “ENGINE START STOP” switch off.

STEP 4 Vehicles without a smart entry & start system: Maintain the engine speed of the second vehicle and turn the engine switch to the “ON” position, then start the vehicle's engine.
Vehicles with a smart entry & start system: Maintain the engine speed of the second vehicle and turn the “ENGINE START STOP” switch to IGNITION ON mode, then start the vehicle's engine.

STEP 5 Once the vehicle's engine has started, remove the jumper cables in the exact reverse order in which they were connected.

Once the engine starts, have the vehicle checked at any authorized Toyota dealer or repairer, or another duly qualified and equipped professional as soon as possible.

■ **Starting the engine when the battery is discharged**

The engine cannot be started by push-starting.

■ **Avoiding a discharged battery**

- Turn off the headlights and the air conditioning system while the engine is off.
- Turn off any unnecessary electrical components when the vehicle is running at a low speed for an extended period, such as in heavy traffic, etc.

■ **Charging the battery**

The electricity stored in the battery will discharge gradually even when the vehicle is not in use, due to natural discharge and the draining effects of certain electrical appliances. If the vehicle is left for a long time, the battery may discharge, and the engine may be unable to start. (The battery recharges automatically during driving.)

■ **Precautions when the battery is discharged (vehicles with a smart entry & start system)**

- In some cases, it may not be possible to unlock the doors using the smart entry & start system when the battery is discharged. Use the wireless remote control or the mechanical key to lock or unlock the doors.
- The engine may not start on the first attempt after the battery has recharged but will start normally after the second attempt. This is not a malfunction.

- The “ENGINE START STOP” switch mode is memorized by the vehicle. When the battery is reconnected, the system will return to the mode it was in before the battery was discharged. Before disconnecting the battery, turn the “ENGINE START STOP” switch off. If you are unsure what mode the “ENGINE START STOP” switch was in before the battery discharged, be especially careful when reconnecting the battery.

CAUTION

■ Avoiding battery fires or explosions

Observe the following precautions to prevent accidentally igniting the flammable gas that may be emitted from the battery.

- Make sure the jumper cable is connected to the correct terminal and that it is not unintentionally in contact with any part other than the intended terminal.
- Do not allow the jumper cables to come into contact with the “+” and “-” terminals.
- Do not allow open flame or use matches, cigarette lighters or smoke near the battery.

■ Battery precautions

The battery contains poisonous and corrosive acidic electrolyte, while related parts contain lead and lead compounds. Observe the following precautions when handling the battery.

- When working with the battery, always wear safety glasses and take care not to allow any battery fluids (acid) to come into contact with skin, clothing or the vehicle body.
- Do not lean over the battery.
- In the event that battery fluid comes into contact with the skin or eyes, immediately wash the affected area with water and seek medical attention. Place a wet sponge or cloth over the affected area until medical attention can be received.
- Always wash your hands after handling the battery support, terminals, and other battery-related parts.
- Do not allow children near the battery.

 **CAUTION**

■ **To prevent damage to the vehicle**

Do not pull- or push-start the vehicle as the three-way catalytic converter may overheat and become a fire hazard.

 **NOTICE**

■ **When handling jumper cables**

Be careful that the jumper cables do not become tangled in the cooling fans or any of the belts when connecting or disconnecting them.

■ **When closing the doors**

While pushing the door glass towards the inside of the vehicle, slowly close the door.

Because the side window open/close function linked to door operation will not operate, the window may interfere with the vehicle body, possibly scratching both the vehicle body and window, or even shattering the window.

5-2. Steps to take in an emergency

If your vehicle overheats

If your engine overheats:

STEP 1 Stop the vehicle in a safe place and turn off the air conditioning system.

STEP 2 Check to see if steam is coming out from under the hood.

If you see steam:

Stop the engine. Carefully lift the hood after the steam subsides and then restart the engine.

If you do not see steam:

Leave the engine running and carefully lift the hood.

STEP 3 Check to see if the cooling fan is operating.

If the fan is operating:

Wait until the temperature of the engine (shown on the instrument cluster) begins to fall and then stop the engine.

If the fan is not operating:

Stop the engine and call any authorized Toyota dealer or repairer, or another duly qualified and equipped professional.

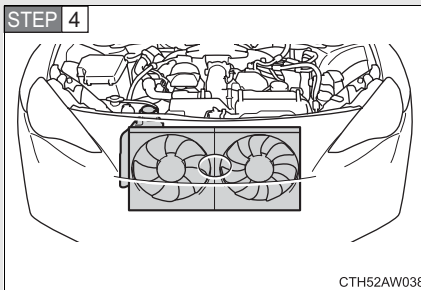

After the engine has cooled down sufficiently, check the engine coolant level and inspect the radiator core (radiator) for any leaks.

STEP 5

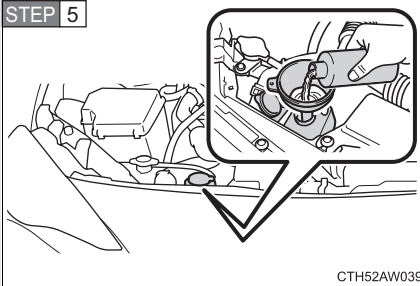

Add engine coolant if necessary.

Water can be used in an emergency if engine coolant is unavailable. (→P. 441)

Have the vehicle checked at the nearest authorized Toyota dealer or repairer, or another duly qualified and equipped professional as soon as possible.

■ Overheating

If you observe the following, your vehicle may be overheating.

- The engine coolant temperature gauge enters the red zone or a loss of power is experienced.
- Steam is coming from under the hood.

▲ CAUTION

■ To prevent an accident or injury when inspecting under the hood of your vehicle

- If steam is seen coming from under the hood, do not open the hood until the steam has subsided. The engine compartment may be very hot, causing serious injury such as burns.
- Keep hands and clothing away from the fan and other belts while the engine is running.
- Do not loosen the radiator cap while the engine and radiator are hot. Serious injury, such as burns, may result from hot coolant and steam released under pressure.

**NOTICE****■ When adding engine coolant**

Wait until the engine has cooled down before adding engine coolant. When adding coolant, do so slowly. Adding cool coolant to a hot engine too quickly can cause damage to the engine.

5-2. Steps to take in an emergency If the vehicle becomes stuck

Carry out the following procedures if the tires spin or the vehicle becomes stuck in mud, dirt, or snow:

- STEP 1** Stop the engine. Set the parking brake and shift the shift lever to P (vehicles with an automatic transmission) or N (vehicles with a manual transmission).
- STEP 2** Remove the mud, snow or sand from around the rear wheels.
- STEP 3** Place wood, stones or some other material under the rear wheels to help provide traction.
- STEP 4** Restart the engine.
- STEP 5** Shift the shift lever to the D or R position (vehicles with an automatic transmission) or 1 or R position (vehicles with a manual transmission) and release the parking brake. Then, while exercising caution, depress the accelerator pedal.

■ When it is difficult to free the vehicle

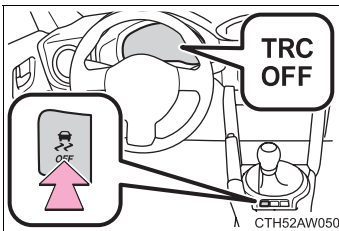

Press  to turn off TRC.

 **CAUTION****■ When attempting to free a stuck vehicle**

If you choose to push the vehicle back and forth to free it, make sure the surrounding area is clear to avoid striking other vehicles, objects or people. The vehicle may also lunge forward or lunge back suddenly as it becomes free. Use extreme caution.

■ When shifting the shift lever

For vehicles with an automatic transmission, be careful not to shift the shift lever with the accelerator pedal depressed.

This may lead to unexpected rapid acceleration of the vehicle that may cause an accident resulting in death or serious injury.

 **NOTICE****■ To avoid damage to the transmission and other components**

- Avoid spinning the rear wheels and depressing the accelerator pedal more than necessary.
- If the vehicle remains stuck even after these procedures are performed, the vehicle may require towing to be freed.

5-2. Steps to take in an emergency

If your vehicle has to be stopped in an emergency

Only in an emergency, such as if it becomes impossible to stop the vehicle in the normal way, stop the vehicle using the following procedure:

STEP 1 Steadily step on the brake pedal with both feet and firmly depress it.

Do not pump the brake pedal repeatedly as this will increase the effort required to slow the vehicle.

STEP 2 Shift the shift lever to N.

If the shift lever is shifted to N

STEP 3 After slowing down, stop the vehicle in a safe place by the road.

STEP 4 Stop the engine.

If the shift lever cannot be shifted to N

STEP 3 Keep depressing the brake pedal with both feet to reduce vehicle speed as much as possible.

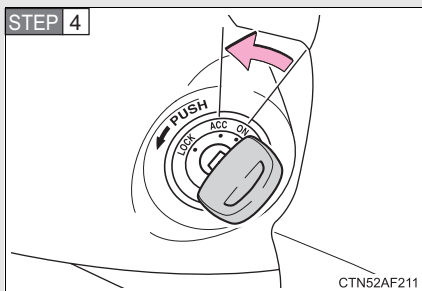

Vehicles without a smart entry & start system: Stop the engine by turning the engine switch to the “ACC” position.

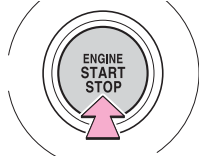
STEP 4

Press and hold for 2 seconds or more,
or press briefly 3 times or more

CTY52AD212

Vehicles with a smart entry & start system: To stop the engine, press and hold the “ENGINE START STOP” switch for 2 consecutive seconds or more, or press it briefly 3 times or more in succession.

STEP 5

Stop the vehicle in a safe place by the road.

 **CAUTION**

■ If the engine has to be turned off while driving

- Power assist for the brakes and steering wheel will be lost, making the brake pedal harder to depress and the steering wheel heavier to turn. Decelerate as much as possible before turning off the engine.
- Vehicles without a smart entry & start system: Never attempt to remove the key, as doing so will lock the steering wheel.

Vehicle specifications

6

6-1. Specifications

Maintenance data (fuel, oil level, etc.).....	434
Fuel information	447

6-2. Customization

Customizable features	449
-----------------------------	-----

6-1. Specifications

Maintenance data (fuel, oil level, etc.)

Dimensions and weight

Overall length		4240 mm (166.9 in.) ^{*2} 4255 mm (167.5 in.) ^{*3}
Overall width		1775 mm (69.9 in.) ^{*4} 1795 mm (70.6 in.) ^{*5}
Overall height ^{*1}		1320 mm (52.0 in.)
Wheelbase		2570 mm (101.2 in.)
Tread	Front	1520 mm (59.8 in.)
	Rear	1540 mm (60.6 in.)
Gross vehicle mass		Details are described on the manufacturer's label. (→P. 435)
Maximum permissible axle capacity	Front	876 kg (1931 lb.)
	Rear	943 kg (2079 lb.)

*1: Unladen vehicle

*2: Vehicles without a front spoiler

*3: Vehicles with a front spoiler

*4: Vehicles without side skirts

*5: Vehicles with side skirts

Vehicle identification

■ Vehicle identification number

The vehicle identification number (VIN) is the legal identifier for your vehicle. This is the primary identification number for your Toyota. It is used in registering the ownership of your vehicle.

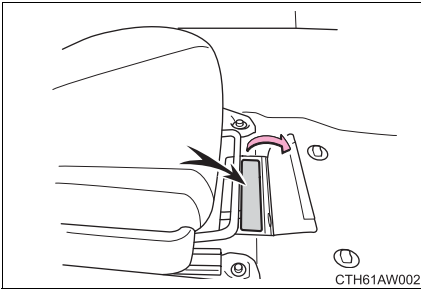

This number is stamped under the right-hand front seat.

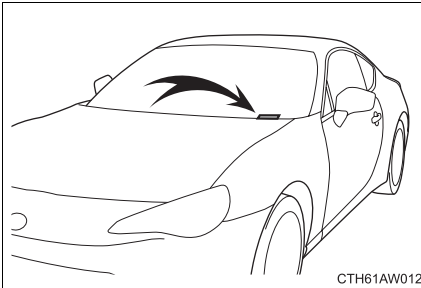

This number is located on the top left of the body panel.

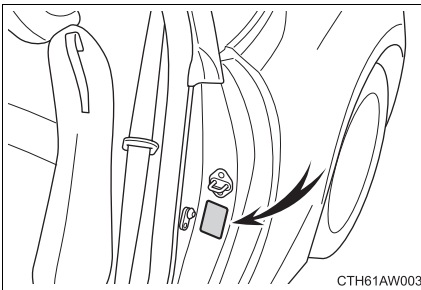

This number is also on the manufacturer's label.

■ **Engine number**

The engine number is stamped on the engine block as shown.

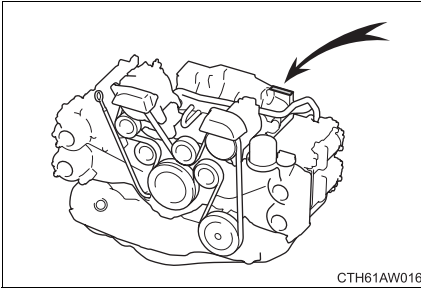

Engine

Model	FA20
Type	Horizontally opposed, liquid cooled 4 cylinder, four-stroke gasoline
Bore and stroke	86.0 × 86.0 mm (3.39 × 3.39 in.)
Displacement	1998 cm ³ (121.93 cu.in.)
Drive belt tension	Automatic adjustment

Fuel

Fuel type	EU area: Unleaded gasoline conforming to European standard EN228 only Except EU area: Unleaded gasoline only
Research octane number	98 or higher*
Fuel tank capacity (Reference)	50 L (13.2 gal., 11.0 Imp. gal.)

*: If unleaded gasoline with an octane rating of 98 RON is not available, unleaded gasoline with an octane rating of 95 RON may be used with no detriment to engine durability or driveability.

Lubrication system

Oil capacity (Drain and refill — reference*)	
Without filter	5.2 L (5.5 qt., 4.6 Imp. qt.)
With filter	5.4 L (5.7 qt., 4.8 Imp. qt.)

*: The engine oil capacity is a reference quantity to be used when changing the engine oil. Warm up and turn off the engine, wait more than 5 minutes, and check the oil level on the dipstick.

■ Engine oil selection

“Toyota Genuine Motor Oil” is used in your Toyota vehicle. Toyota recommends the use of approved “Toyota Genuine Motor Oil”. Another motor oil of matching quality can also be used.

Oil grade:

0W-20 and 5W-30:

API grade SL “Energy-Conserving”, SM “Energy-Conserving”, SN “Resource-Conserving” or ILSAC multigrade engine oil

Recommended viscosity (SAE):

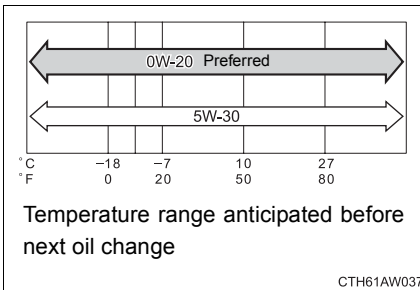

SAE 0W-20 is filled into your Toyota vehicle at manufacturing, and the best choice for good fuel economy and good starting in cold weather.

If SAE 0W-20 oil is not available, SAE 5W-30 oil may be used. However, it should be replaced with SAE 0W-20 at the next oil change.

Oil viscosity (0W-20 is explained here as an example):

- The 0W in 0W-20 indicates the characteristic of the oil which allows cold startability. Oils with a lower value before the W allow for easier starting of the engine in cold weather.
- The 20 in 0W-20 indicates the viscosity characteristic of the oil when the oil is at high temperature. An oil with a higher viscosity (one with a higher value) may be better suited if the vehicle is operated at high speeds, or under extreme load conditions.

How to read oil container labels:

Either or both API registered marks are added to some oil containers to help you select the oil you should use.

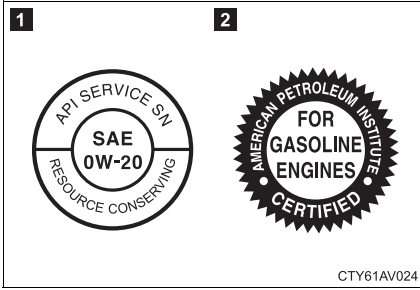

1 API Service Symbol

Top portion: The oil quality designation by API (American Petroleum Institute) (SN)

Center portion: The SAE viscosity grade (SAE 0W-20)

Lower portion: “Resource-Conserving” means that the oil has fuel saving and environmental protection.

2 ILSAC Certification Mark

The ILSAC (International Lubricant Specification Advisory Committee) Certification Mark is displayed on the front of the container.

Cooling system

Capacity	<p>Vehicles with an automatic transmission 7.5 L (7.9 qt., 6.6 Imp. qt.)</p> <p>Vehicles with a manual transmission 7.2 L (7.6 qt., 6.3 Imp. qt.)</p>
Coolant type	<p>Use either of the following.</p> <ul style="list-style-type: none"> • “TOYOTA Genuine 50/50 Pre-mixed Super Long Life Coolant BLUE” • Similar high-quality ethylene glycol-based non-silicate, non-amine, non-nitrite, and non-borate coolant with long-life hybrid organic acid technology <p>Do not use plain water alone.</p>

Ignition system

Spark plug	
Make	DENSO ZXE27HBR8
Gap	0.8 mm (0.031 in.)

NOTICE

Iridium-tipped spark plugs

Use only iridium-tipped spark plugs. Do not adjust gap when tuning engine.

Electrical system

Battery	
Specific gravity reading at 20°C (68°F):	1.250 — 1.290 Fully charged 1.160 — 1.200 Half charged 1.060 — 1.100 Discharged
Charging rates	
Quick charge	15 A max.
Slow charge	5 A max.

Differential

Oil capacity (Reference)	1.15 L (1.22 qt., 1.01 Imp. qt.)
Oil type and viscosity*	<p>Without LSD</p> <ul style="list-style-type: none"> • Toyota Genuine Differential Gear Oil LT • Other gear oil that meets API GL-5 and SAE 75W-85 <p>With LSD</p> <ul style="list-style-type: none"> • Toyota Genuine Differential Gear Oil LX • Other LSD gear oil that meets API GL-5 and SAE 75W-85

*: Your Toyota vehicle is filled with “Toyota Genuine Differential Gear Oil” at the factory. Use Toyota approved “Toyota Genuine Differential Gear Oil” or an equivalent of matching quality to satisfy the above specification. Please contact any authorized Toyota dealer or repairer, or another duly qualified and equipped professional for further details.

 NOTICE

Differential gear oil

Using a differential gear oil other than “Toyota Genuine Differential Gear Oil” may cause occurrences of rattling noises while idling and poor fuel consumption.

Never use different brands together.

Automatic transmission

Fluid capacity*	7.5 L (7.9 qt., 6.6 Imp. qt.)
Fluid type	TOYOTA Genuine ATF WS

*: The fluid capacity is provided as a reference.

If replacement is necessary, contact any authorized Toyota dealer or repairer, or another duly qualified and equipped professional.

 NOTICE

Using automatic transmission fluid other than “TOYOTA Genuine ATF WS” may cause deterioration in shift quality, locking up of your transmission accompanied by vibration, and ultimately damage the automatic transmission of your vehicle.

Manual transmission

Gear oil capacity (Reference)	2.2 L (2.3 qt., 1.9 Imp. qt.)
Gear oil type and viscosity	Use either of the following: <ul style="list-style-type: none"> • “TOYOTA Genuine MG Gear Oil special II” • Other gear oil that meets API GL-3* and SAE 75W-90 specifications

*: The recommended oil grade is API GL-3. However, API GL-4 can also be used.



NOTICE

Manual transmission gear oil

Using a manual transmission gear oil other than “TOYOTA Genuine MG Gear Oil special II” may cause occurrences of rattling noises while idling and poor fuel consumption.

Never use different brands together.

Clutch

Pedal free play	5 — 15 mm (0.2 — 0.6 in.)
Fluid type	SAE J1703 or FMVSS No.116 DOT 3 or SAE J1704 or FMVSS No.116 DOT 4

Brakes

Pedal clearance ^{*1}	55.0 mm (2.16 in.) min.
Pedal free play	0.5 — 2.7 mm (0.020 — 0.106 in.)
Parking brake lever travel ^{*2}	7 — 8 clicks
Fluid type	SAE J1703 or FMVSS No.116 DOT 3 or SAE J1704 or FMVSS No.116 DOT 4

*1: Minimum pedal clearance when depressed with a force of 490 N (50 kgf, 110 lbf) while the engine is running.

*2: Parking brake lever travel when pulled up with a force of 200 N (20.4 kgf, 45.0 lbf).

Steering

Free play	Less than 30 mm (1.2 in.)
-----------	---------------------------

Tires and wheels

Tire size	205/55R16 91V, 215/45R17 87W
Tire inflation pressure (Recommended cold tire inflation pressure)	240 kPa (2.4 kgf/cm ² or bar, 35 psi)
Wheel size	16 × 6 1/2 J, 17 × 7 J
Wheel nut torque	120 N•m (12.2 kgf•m, 89 ft•lbf)

Light bulbs

	Light Bulbs	W	Type
Exterior	Headlights		
	High beam (halogen bulbs)	60	D
	Low/high beam (discharge bulbs)	35	A
	Low beam (halogen bulbs)	55	B
	Front turn signal lights	21	C
	Front position lights (vehicles with halogen headlights)	5	E
	Daytime running lights	13	—
	Front fog lights (vehicles with discharge headlights)	24	—
	Front fog lights (vehicles with halogen headlights) (if equipped)	35	G
	Rear turn signal lights	21	C
	Back-up lights	16	E
	Rear fog lights	21	E
	License plate lights	5	E
Side turn signal lights	5	C	
Interior	Vanity lights (if equipped)	2	F
	Interior light	10	F
	Door courtesy lights (if equipped)	5	C
	Trunk light (if equipped)	5	C

A: D4S discharge bulbs

C: Wedge base bulbs (amber)

E: Wedge base bulbs (clear)

G: H8 halogen bulbs

B: H11 halogen bulbs

D: HB3 halogen bulbs

F: Double end bulbs

Fuel information

The engine is designed to operate at maximum performance using unleaded gasoline with an octane rating of 98 or higher. If 98 RON fuel is not readily available in your area, unleaded gasoline with an octane rating of 95 RON may be used with no detriment to engine durability or driveability. However, you may notice a slight decrease in maximum engine performance and you may hear some knocking (pinking) of an engine while using 95 RON fuel. Use of 95 RON fuel will not affect your warranty coverage.

■ Fuel tank opening for unleaded gasoline

To help prevent incorrect fueling, your Toyota has a fuel tank opening that only accommodates the special nozzle on unleaded fuel pumps.

■ If your engine knocks

- Consult any authorized Toyota dealer or repairer, or another duly qualified and equipped professional.
- You may occasionally notice light knocking for a short time while accelerating or driving uphill. This is normal and there is no need for concern.



NOTICE

■ Notice on fuel quality

- Do not use improper fuels. If improper fuels are used the engine will be damaged.
- Do not use leaded gasoline.
Leaded gasoline will cause the three-way catalytic converter to lose its effectiveness and the emission control system to function improperly.
- Do not use the methanol blended gasoline such as M15, M85, M100.
The use of gasoline containing methanol may cause engine damage or failure.
- EU area: Bioethanol fuel sold under names such as “E50” or “E85” and fuel containing a large amount of ethanol should not be used. The use of these fuels will damage the vehicle’s fuel system. In case of any doubt, ask any authorized Toyota dealer or repairer, or another duly qualified and equipped professional.
- Except EU area: Bioethanol fuel sold under names such as “E50” or “E85” and fuel containing a large amount of ethanol should not be used. Your vehicle can use gasoline mixed with 10% max ethanol. The use of fuel with more than 10% ethanol content (E10) will damage the vehicle’s fuel system. You must ensure that refueling is carried out only from a source where fuel specification and quality can be guaranteed. In case of any doubt, ask any authorized Toyota dealer or repairer, or another duly qualified and equipped professional.

6-2. Customization

Customizable features

Your vehicle includes a variety of electronic features that can be personalized to your preferences. Programming these preferences requires specialized equipment and may be performed by any authorized Toyota dealer or repairer, or another duly qualified and equipped professional.

Some function settings are changed simultaneously with other functions being customized. Contact any authorized Toyota dealer or repairer, or another duly qualified and equipped professional.

Item	Function	Default setting	Customized setting
Smart entry & start system (→P. 33)	Smart entry & start system	On	Off
	Operation signal (Emergency flashers)	On	Off
	Number of permissible times of continuous smart lock	Twice	Unlimited
Wireless remote control (→P. 51)	Time elapsed before automatic door lock function is activated if door is not opened after being unlocked	30 seconds	60 seconds
			120 seconds
	Operation signal (Emergency flashers)	On	Off
	Door lock buzzer (vehicles with a smart entry & start system)	On	Off
	Trunk unlocking function	On	Off

Item	Function	Default setting	Customized setting
Wireless remote control (→P. 51)	Trunk unlocking operation	Push and hold (short)	Push and hold (long)
			One short push
			Two short pushes
Automatic light control system (→P. 208)	Light sensor sensitivity	±0%	-40% to +40%
Lights (→P. 208)	Time that the low beam headlights are on when the vehicle is parked	30 seconds	60 seconds
			90 seconds
			120 seconds
Rear window defogger (→P. 256)	Time elapsed before the rear window defogger turn off (vehicles with an automatic air conditioning system)	15 minutes	Continue
Illumination (→P. 259)	Time elapsed before lights turn off	15 seconds	7.5 seconds
			30 seconds
	Operation when the doors are unlocked	On	Off
	Operation after the engine switch is turned off	On	Off
	Interior light illumination upon approach (vehicles with a smart entry & start system)	On	Off
	Interior light illumination	On	Off

Index

Abbreviation list	452
Alphabetical index.....	453
What to do if...	462

Abbreviation list

Abbreviation/Acronym list

ABBREVIATIONS	MEANING
ABS	Anti-lock Brake System
ACC	Accessory
AI-SHIFT	Artificial Intelligence Shift
CRS	Child Restraint System
DISP	Display
ECU	Electronic Control Unit
EDR	Event Data Recorder
ELR	Emergency Locking Retractor
EPS	Electric Power Steering
LED	Light Emitting Diode
LSD	Limited Slip Differential
SRS	Supplemental Restraint System
TPMS	Tire Pressure Warning System
TRC	Traction Control
VIN	Vehicle Identification Number
VSC	Vehicle Stability Control

Alphabetical index

Alphabetical index

A

A/C	240, 248
ABS	225
Air conditioning filter	329
Air conditioning system	
Air conditioning filter.....	329
Automatic air conditioning system	248
Manual air conditioning system	240
Airbags	
Airbag manual on/off system	152
Airbag operating conditions	114, 120
Airbag precautions for your child	126
Airbag warning light	375
Curtain shield airbag operating conditions	120
Curtain shield airbag precautions	126
General airbag precautions...	126
Locations of airbags.....	105
Modification and disposal of airbags.....	130
Proper driving posture...	103, 126
Side airbag operating conditions	120
Side airbag precautions	126
Side and curtain shield airbags operating conditions	120
Side and curtain shield airbags precautions	126
SRS airbags.....	105

Anti-lock brake system	225
Ashtray	270
Audio input	258
Audio system	
Audio input.....	258
AUX port	258
Portable music player	258
USB port	258
Automatic air conditioning system	248
Automatic headlight leveling system	212
Automatic light control system	208
Automatic transmission	
Automatic transmission.....	181
If the shift lever cannot be shifted from P	414
Manual mode.....	184
Mode select switch	183
AUX port	258
Auxiliary box	278

B

Back-up lights

- Replacing light bulbs 344
- Wattage 446

Battery

- Checking 309
- If the vehicle has a
 - discharged battery 420
- Preparing and checking
 - before winter 233

Bottle holders 263

Brake

- Parking brake 192

Brake assist 225

Break-in tips 159

Brightness control

- Instrument panel light
 - control 196

C

Care

- Alcantara® 290
- Exterior 282
- Interior 286
- Seat belts 287

Chains 233

Child restraint system

- Baby seats, definition 134
- Baby seats, installation 142
- Child seats, definition 134
- Child seats, installation 142
- Installing CRS with ISOFIX
 - rigid anchor 146
- Installing CRS with
 - seat belts 143
- Installing CRS with
 - top straps 147
- Junior seats, definition 134
- Junior seats, installation 142

Child safety

- Airbag precautions 126
- Battery precautions 312, 423
- Child restraint system 134
- How your child should
wear the seat belt 74
- Installing child restraints 142
- Power window lock switch 84
- Power window precautions 87
- Removed key battery
precautions 335
- Seat belt guide 73
- Seat belt precautions 75
- Seat heater precautions 273
- Trunk precautions 61

Cleaning

- Alcantara® 290
- Exterior 282
- Interior 286
- Seat belts 287

Clock 268**Condenser 308****Console tray 264****Cooling system**

- Engine overheating 425

Cruise control 220**Cup holders 264****Customizable features 449****D****Daytime running light**

- system 211**

Defogger

- Rear window 256
- Side mirror 256

Dimension 434**Display**

- Multi-information display 203
- Trip information 204

Do-it-yourself maintenance 295**Door courtesy lights**

- Door courtesy lights 259
- Wattage 446

Doors

- Door lock 33, 51, 56
- Door windows 84
- Double locking system 101
- Side mirrors 81

Driver's seat belt

- reminder light 377**

Driving

- Break-in tips 159
- Correct posture 103
- Procedures 156
- Winter drive tips 233

E **Electric power steering** 225

Electronic key

- If the electronic key does not operate properly 416

Emergency flashers

- Switch 364

Emergency, in case of

- If the electronic key does not operate properly 416
- If the engine will not start 411
- If the shift lever cannot be shifted from P 414
- If the vehicle has a discharged battery 420
- If the warning buzzer sounds 374
- If the warning light turns on 374
- If you have a flat tire 386, 395
- If you lose your keys 415
- If you think something is wrong 372
- If your vehicle becomes stuck 428
- If your vehicle has to be stopped in an emergency 430
- If your vehicle needs to be towed 365
- If your vehicle overheats 425

Engine

- Compartment 302
- Engine switch 169, 178
- Hood 298
- How to start the engine 169, 178
- Identification number 435
- If the engine will not start 411
- Ignition switch 169, 178
- Overheating 425

Engine coolant

- Capacity 441
- Checking 306

Engine coolant temperature gauge 194

Engine immobilizer system 92

Engine oil

- Capacity 438
- Checking 303
- Preparing and checking before winter 233

Engine switch 169, 178

Engine switch light 259

EPS 225

Event data recorder 24

F	Floor mat	275
	Fluid	
	Washer.....	313
	Fog lights	
	Replacing light bulbs.....	344
	Switch	215
	Wattage.....	446
	Front fog lights	
	Replacing light bulbs.....	344
	Switch	215
	Wattage.....	446
	Front passenger's seat belt reminder light	377
	Front position lights	
	Replacing light bulbs.....	344
	Switch	208
	Wattage.....	446
	Front seats	
	Adjustment.....	64
	Front turn signal lights	
	Replacing light bulbs.....	344
	Switch	191
	Wattage.....	446
	Fuel	
	Capacity.....	437
	Fuel gauge.....	194
	Fuel pump shut off system....	373
	Gas station information.....	464
	Information.....	447
	Refueling.....	88
	Fuel door	88
	Fuel filler door	88
	Fuel pump shut off system	373
	Fuses	336

G	Gauges	194
	Glove box	262

H	Hazard lights	
	Switch	364
	Head restraints	
	Adjusting	70
	Headlight cleaner	217
	Headlights	
	Discharge headlight	
	precautions.....	362
	Replacing light bulbs.....	344
	Switch	208
	Wattage	446
	Heaters	
	Seat heaters	273
	Side mirror	256
	Hood	298
	Horn	193

I	Identification	
	Engine.....	435
	Vehicle	435
	Ignition switch	169, 178
	Ignition switch light	
	Ignition switch light.....	259
	Illuminated entry system	259
	Immobilizer system	92
	Indicator lights	198
	Inside rear view mirror	80
	Interior light	
	Interior light.....	260
	Switch	260
	Wattage	446

J

Jack

- Positioning a floor jack 300
- Vehicle-equipped
jack 386, 395

Jack handle 386, 395

K

Keyless entry 51

Keys

- Electronic key 30
- Engine switch 169, 178
- If you lose your keys 415
- If your electronic key
battery is discharged 416
- Key number 30
- Keyless entry 51
- Keys 30
- Mechanical key 31
- Wireless remote control key... 51

L

License plate lights

- Replacing light bulbs 344
- Wattage 446

Light bulbs

- Replacing 344
- Wattage 446

Lights

- Door courtesy lights 259
- Emergency flasher switch 364
- Engine switch light 259
- Fog light switch 215
- Hazard light switch 364
- Headlights switch 208
- Interior light switch 260
- Replacing light bulbs 344
- Turn signal lever 191
- Vanity lights 267
- Wattage 446

M

Maintenance

- Do-it-yourself maintenance... 295
- Maintenance data 434
- Maintenance requirements ... 292

Manual air conditioning

system 240

Manual transmission 188

Meter

- Instrument panel
light control 196
- Meters 194

Mirrors

- Inside rear view mirror 80
- Side mirror heater 256
- Side mirrors 81
- Vanity mirrors 267

Multi-information display 203

O

Odometer 194

Oil

- Engine oil 303

Opener

- Fuel filler door 88
- Hood 298
- Trunk 59

Outside rear view mirrors

- Adjusting and folding 81

Outside temperature

display 269

Overheating, Engine 425

P

Parking brake 192

Power outlets 271

Power windows 84

R **Radiator** 308

Rear fog lights

- Replacing light bulbs 344
- Switch 215
- Wattage 446

Rear seats 68

Rear turn signal lights

- Replacing light bulbs 344
- Switch 191
- Wattage 446

Rear window defogger 256

Replacing

- Fuses 336
- Key battery 332
- Light bulbs 344
- Tires 386

REV indicator 205

S **Seat belts**

- Adjusting the seat belt 72
- Child restraint system
 - installation 142
- Cleaning and maintaining
 - the seat belts 287
- Emergency Locking
 - Retractor (ELR) 74
- How to wear your seat belt 72
- How your child should
 - wear the seat belt 74
- Pregnant women,
 - proper seat belt use 76
- Reminder light 377
- Seat belt guide 73
- Seat belt pretensioners 73

Seat heaters 273

Seats

- Adjustment 64
- Adjustment precautions 67
- Child seats/child restraint
 - system installation 142
- Cleaning 286
- Head restraint 70
- Properly sitting in the seat 103
- Seat heaters 273

Service reminder

- indicators** 198

Shift lever

- Automatic transmission 181
- If the shift lever cannot
 - be shifted from P 414
- Manual transmission 188

Shift lock system 414

Side airbags 105

Side mirror

- Adjusting and folding 81

Side turn signal lights

- Replacing light bulbs 344
- Switch 191
- Wattage 446

Smart entry & start system

- Antenna location 35
- Entry function 33
- Starting the engine 169

Spare tire

- Inflation pressure 445
- Storage location 386

Spark plug 441

Specifications 434

Speedometer	
Speedometer	194
Steering	
Column lock release	79
Steering wheel	
Adjustment.....	79
Storage feature	261
Stuck	
If your vehicle becomes stuck	428
Sun visors	266
Switch	
Airbag manual on/off.....	152
Driving pattern selector switch.....	183
Emergency flasher switch	364
Engine switch.....	169, 178
Fog light switch	215
Hazard light switch.....	364
Ignition switch	169, 178
Light switches	208
“ODO/TRIP” switch	196
Power door lock switch	57
Power window switch.....	84
Transmission shift switches.....	184, 186
“VSC SPORT” switch.....	226
VSC/TRC off switch	226, 228
Window lock switch.....	84
Wiper and washer switch	217

T

Tachometer	
Tachometer.....	194
Tail lights	
Switch	208
Theft deterrent system	
Double locking system.....	101
Engine immobilizer system	92
Tire inflation pressure.....	445
Tires	
Chains.....	233
Checking.....	315
Emergency tire puncture repair kit.....	395
If you have a flat tire	386, 395
Inflation pressure	324
Replacing.....	386
Rotating tires.....	315
Size.....	445
Snow tires	233
Spare tire	386
Tire pressure warning system	315, 377
Tools	386, 395
Towing	
Emergency towing	365
Traction control	225
Transmission shift switches	184, 186
TRC	225
Trip meter	194
Trunk	
Opener	59
Trunk light	
Wattage	446
Turn signal lights	
Replacing light bulbs.....	344
Switch	191
Wattage	446
U	
USB port	258

V**Vanity lights**

- Vanity lights..... 267
- Wattage..... 446

Vanity mirrors 267**Vehicle identification**

- number 435

Vehicle stability control 225**VSC 225****“VSC SPORT” mode..... 226****W****Warning buzzers**

- Electric power steering..... 375
- Seat belt reminder..... 377

Warning lights

- Automatic headlight
 - leveling system 375
- Automatic transmission
 - fluid temperature
 - warning light 377
- Anti-lock brake system..... 375
- Brake assist system..... 375
- Brake system 374
- Charging system 374
- Cruise control
 - indicator light 375
- Electric power steering
 - system warning light 375
- Electronic engine control
 - system 375
- Engine oil pressure 374
- Low fuel level 377
- Low tire pressure 377
- Malfunction indicator lamp ... 375
- Open door 377
- Pretensioners..... 375
- Seat belt reminder light..... 377
- Slip indicator light..... 375
- Smart entry & start
 - system 375, 382
- SRS airbags..... 375

- Tire pressure warning
 - system 377

Washer

- Checking..... 313
- Preparing and checking
 - before winter..... 233
- Switch 217

Washing and waxing 282**Wheels 326****Window glasses 84****Window lock switch 84****Windows**

- Power windows..... 84
- Rear window defogger..... 256
- Washer 217

Windshield wipers 217**Wireless remote control key**

- Locking/Unlocking..... 51
- Replacing the battery..... 332
- Wireless remote control key ... 51

What to do if...

What to do if...

A tire punctures	P. 386 P. 395	If you have a flat tire
The engine does not start	P. 411 P. 92 P. 420	If the engine will not start Engine immobilizer system If the battery is discharged
The shift lever cannot be moved out	P. 414	If the shift lever cannot be shifted from P
The engine coolant temperature gauge enters the red zone	P. 425	If your vehicle overheats
Steam can be seen coming from under the hood		
The key is lost	P. 415	If you lose your keys
The battery runs out	P. 420	If the battery is discharged
The doors cannot be locked	P. 56	Doors
The vehicle is stuck in mud or sand	P. 428	If the vehicle becomes stuck
A warning light or indicator light comes on	P. 374	If a warning light turns on or a warning buzzer sounds...

GAS STATION INFORMATION

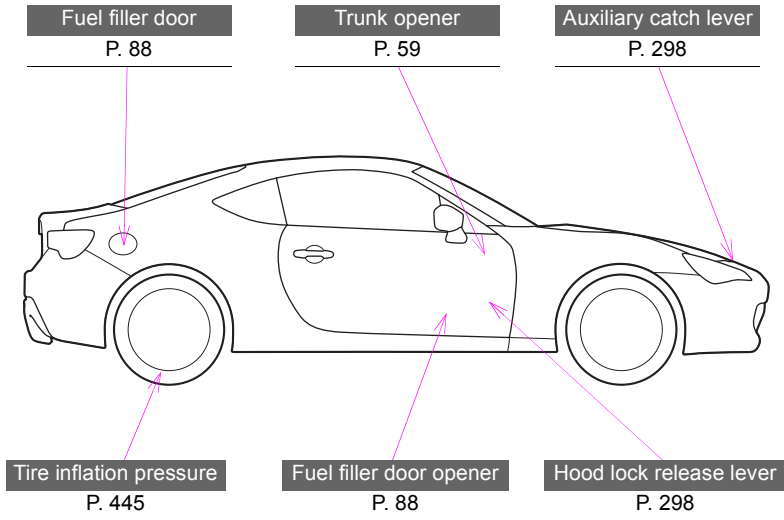

CTHPIAW047

Fuel tank capacity (Reference)	50 L (13.2 gal., 11.0 Imp. gal.)	
Fuel type	Unleaded gasoline only P. 88, 437	
Cold tire inflation pressure	P. 445	
Engine oil capacity (Drain and refill — reference)	Without filter	L (qt., Imp. qt.) 5.2 (5.5, 4.6)
	With filter	5.4 (5.7, 4.8)
Engine oil type	P. 438	